

Montaje para Protector de Carter

Nota:

No apriete todos los tornillos hasta que no estén completamente alineadas todas las perforaciones con respecto a los puntos de sujeción. Antes de realizar la instalación, verifique todo el manual e identifique que las partes y las piezas estén completas.

Herramientas:

1 Rache con copa de 14mm
1 Llave Torx T50



Kit Instalado



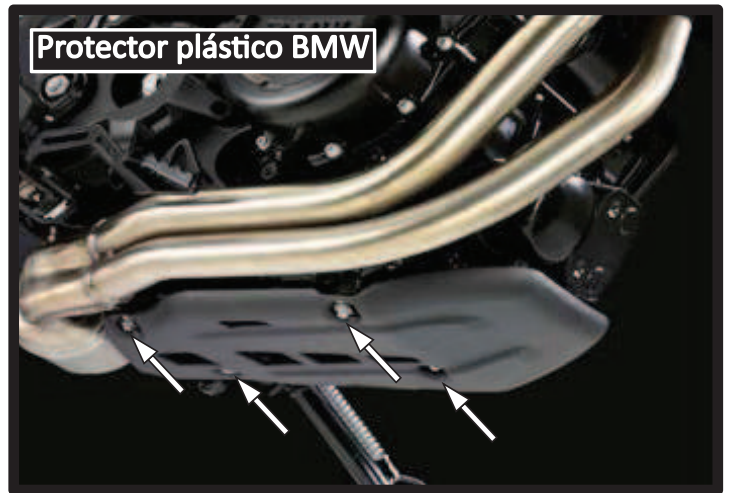

Instalación



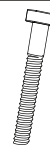

Imagen

1-Remueva el protector plástico original de la moto señalado en la Imagen.

El Kit Contiene:

Protector Carter MASTECH  Cantidad: 1	Tornillo Hexágono M8 X 110 galv  TC1 Cantidad: 1	Tornillo Socket M8 X 12 galv  TC2 Cantidad: 4
--	---	--

Wasa M8 galv  TC3 Cantidad: 1	Caucho Carter MASTECH M8  TC4 Cantidad: 4
---	--

2- Instale el protector de carter MASTECH con la tornillería entregada en el kit, como lo indica el Esquema.

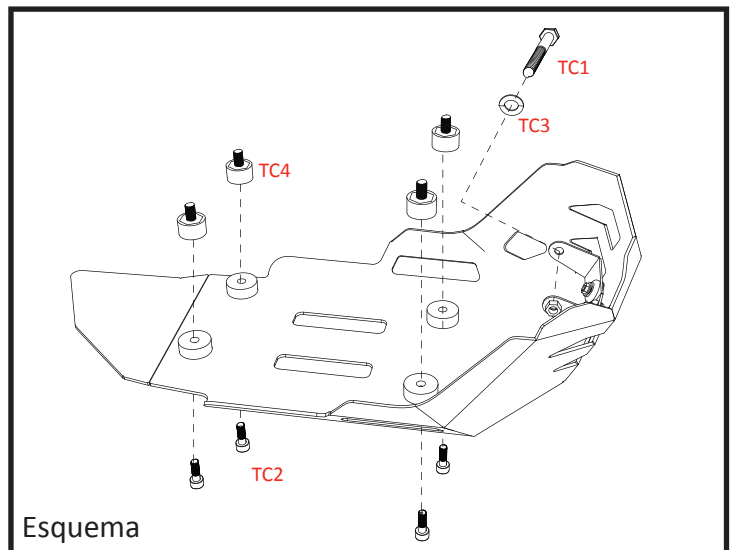

Esquema

Al terminar la instalación de las partes, verifique que estén alineadas y que toda la tornillería esté debidamente apretada; reajuste todos los tornillos.

Assembly Instructions for Engine Guard



Note:

Do not tighten the screws until they are completely aligned with the holes.
Before the installation, please verify through the manual that all pieces and parts are complete.

Tools Required:

- 1 Ratchet and Socket 14mm
- 1 Allen Wrench T50

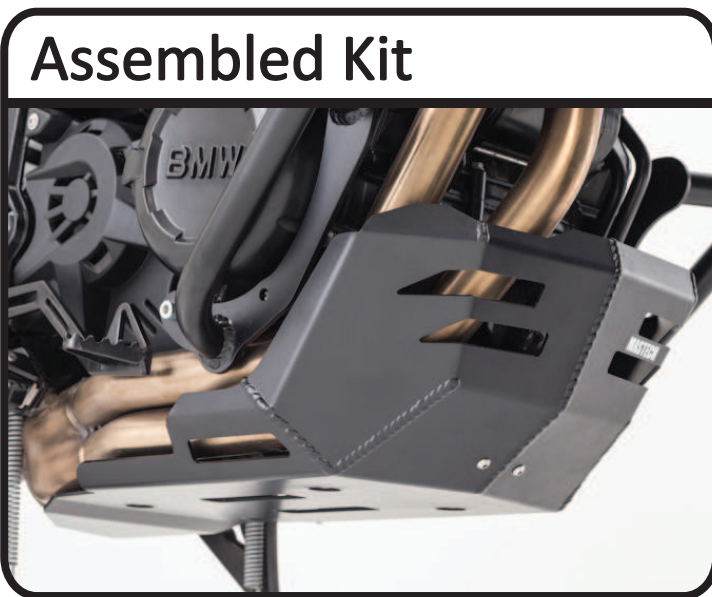

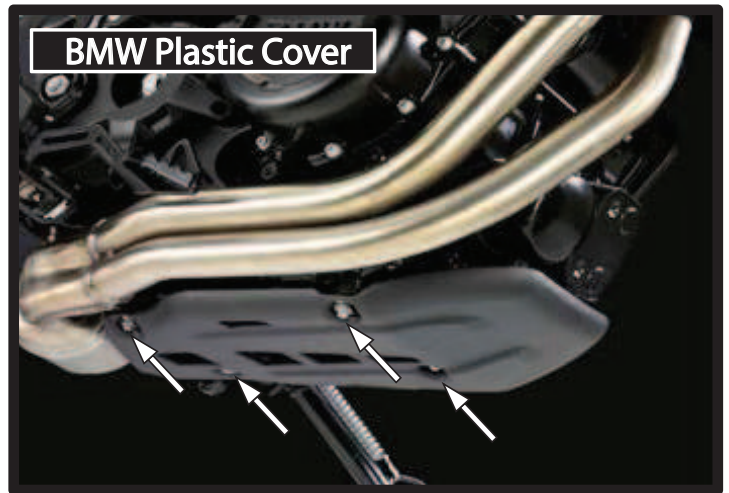

Installation



Image

1- Remove the original plastic cover protector shown in Image.

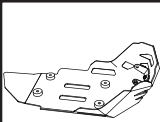
Parts Included:

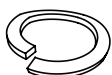
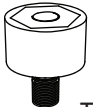
<p>MASTECH Engine Guard</p>  <p>Quantity: 1</p>	<p>Hex Bolt M8 X 110 galv</p>  <p>TC1</p> <p>Quantity: 1</p>	<p>Allen Bolt M8 X 12 galv</p>  <p>TC2</p> <p>Quantity: 4</p>
<p>Spring Washer M8 galv</p>  <p>TC3</p> <p>Quantity: 1</p>	<p>Rubber MASTECH Engine Guard M8</p>  <p>TC4</p> <p>Quantity: 4</p>	<p>2- Install the engine guard from the kit, with the parts delivered as shown in the Diagram.</p>

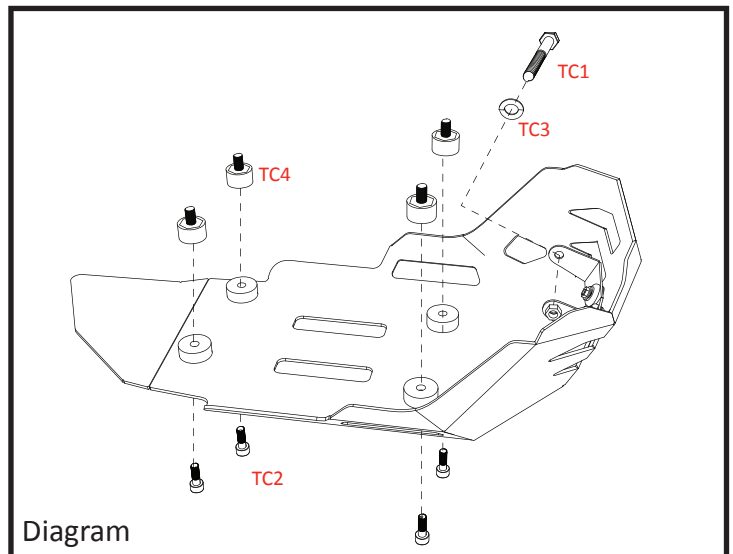

Diagram

After the installation of the parts, please check that they are aligned and that all the hardware is properly tightened.