

MOTOPLASTIC, S.A.

Molí de la sal, 1 - 08403 Granollers (Barcelona) SPAIN

Tel. 34 93 849 06 33 - Fax 34 93 849 09 88

info@puig.tv - info@puigusa.com







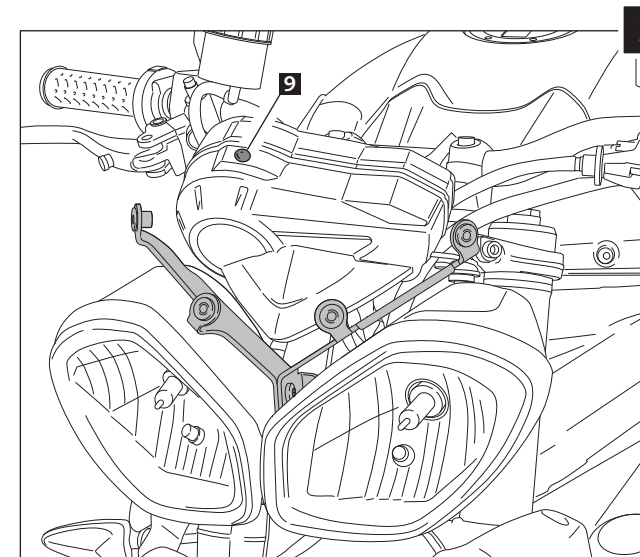
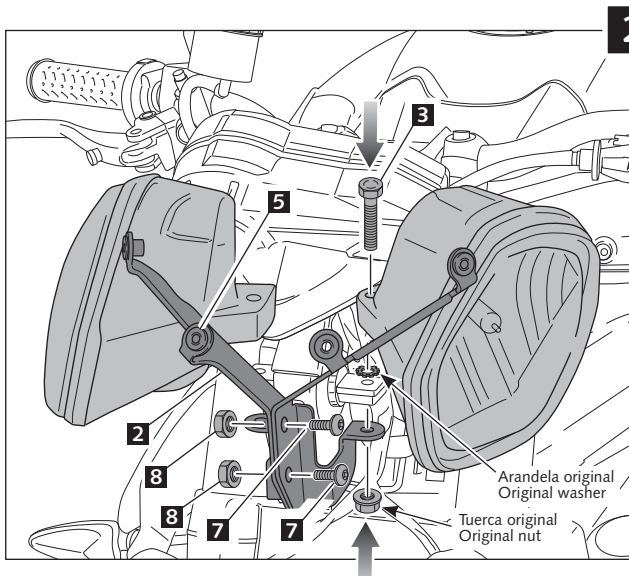
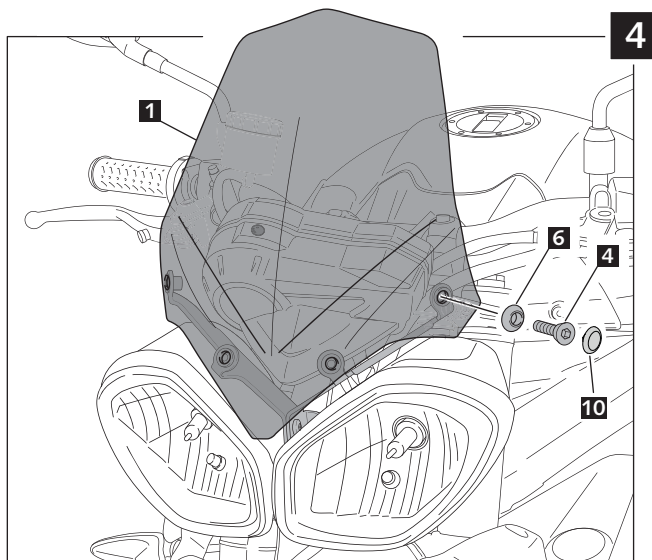
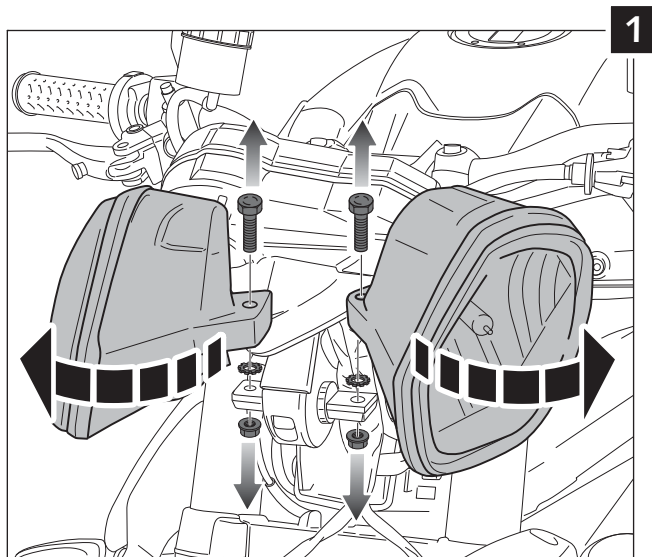

www.puig.tv - www.puigusa.com

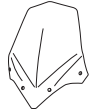
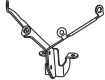
INSTRUCCIONES DE MONTAJE - MOUNTING INSTRUCTIONS

CARENABRÍS ADAPTABLE A - WINDSHIELD ADAPTABLE TO **TRIUMPH** SPEED TRIPLE /R '11- STREET TRIPLE/R '13-

Ref.: 5658



ID.	DESCRIPCIÓN	DESCRIPTION	QTY.
1	 Pantalla	Screen	1
2	 Soporte metálico derecho/izquierdo	Right/left metal support	1
3	 Tornillo hexagonal M8x50	M8x50 hexagonal screw	2
4	 Tornillo Allen M6x25 DIN 7991	M6x25 DIN 7991 Allen screw	4
5	 Tuerca M6 con silemblock incorporado	M6 nut incorporated well nut	4
6	 Arandela cónica plástico Ø20	Ø20 plastic washer	4
7	 Tornillo Allen M6X15 ISO 7380	M6x15 ISO 7380 Allen screw	2
8	 Tuerca M6 grafilada	Special M6 nut	2
9	 Separador de silicona Ø8	Ø8 silicone delimiter	1
10	 Tapón tornillo DIN 7991	DIN 7991 Screw cap	4