

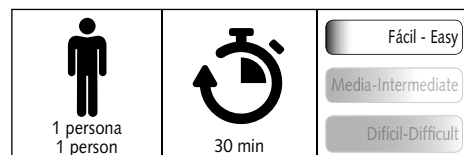

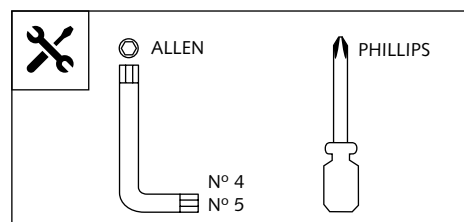

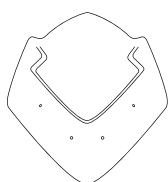

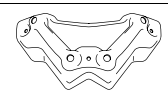
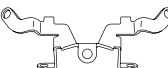

## CARENABRÍS ADAPTABLE A - WINDSHIELD FOR - WINDSCHUTZSCHEIBE FÜR SUZUKI GSX-S1000

Ref.: 7653



ID	PIEZA / PART	DESCRIPCIÓN	DESCRIPTION	QTY	REF.
1		Carenabrís	Windshield	1	7653A/C/F/H/N/R/WM3
2		Tapa negra	Black cover	1	7653A/C/F/H/N/R/WM3
3		Soporte metálico central	Central metal support	1	SOPOR-3P-3-7653
4		Tuerca especial remachada derecha	Right special riveted washer	1	SOPOR-3P-3-7653
5		Tuerca especial remachada izquierda	Left special riveted washer	1	SOPOR-3P-3-7653
6		Tornillo Allen M5x16 ISO 7380 (cabeza pequeña)	M5x16 ISO 7380 Allen screw (small head)	2	TORNIAI7380-281
7		Tornillo Allen M5x16 ISO 7380 (cabeza grande)	M5x16 ISO 7380 Allen screw (big head)	7	TORNI-I7380-493
8		Tapón tornillo M5 ISO 7380	M5 ISO7380 Allen screw cap	7	TAPON-----85
9		Arandela de nylon M5x0,5	M5x0,5 nylon washer	7	ARNV00000000245
10		Silentblock M5	M5 Silentblock	7	SILENBM5-046/1

## CARENABRÍS ADAPTABLE A - WINDSHIELD FOR - WINDSCHUTZSCHEIBE FÜR SUZUKI GSX-S1000

### INSTRUCCIONES DE MONTAJE - MOUNTING INSTRUCTIONS - MONTAGEANLEITUNG

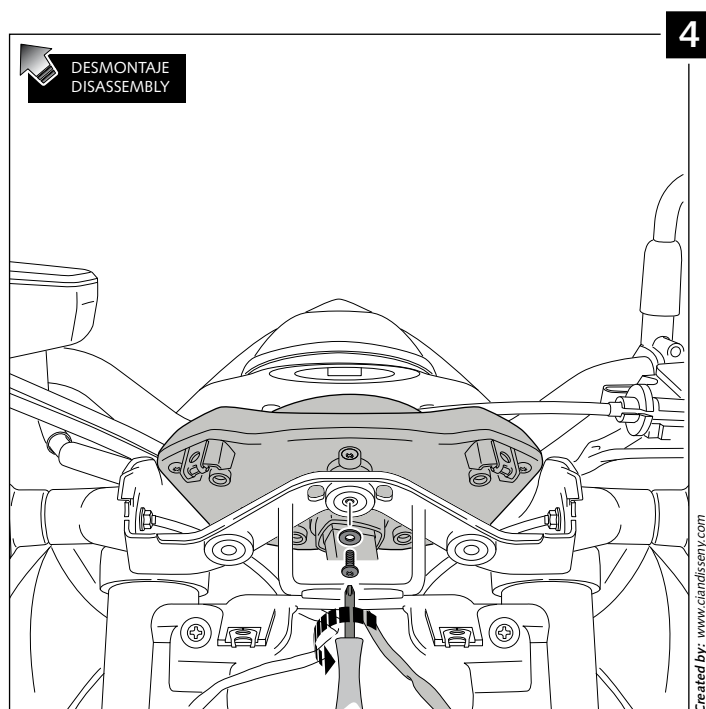
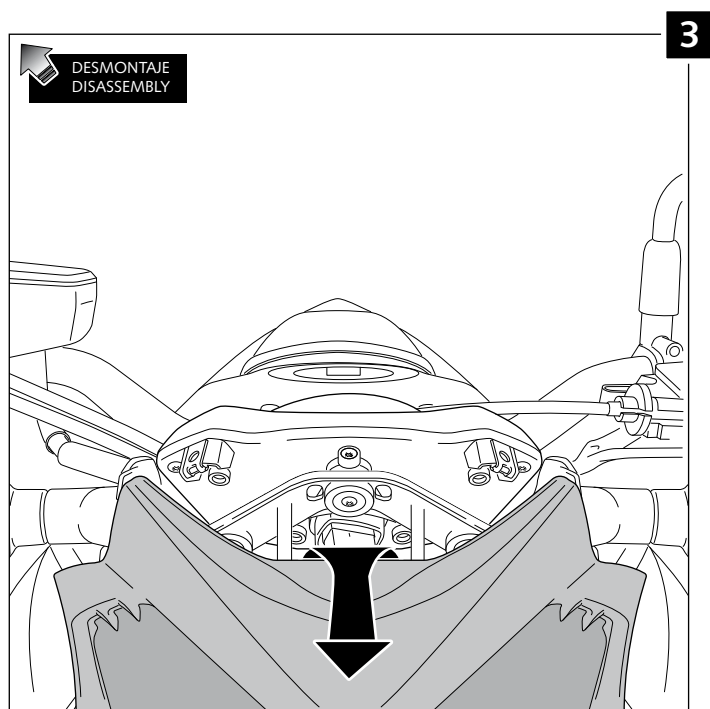
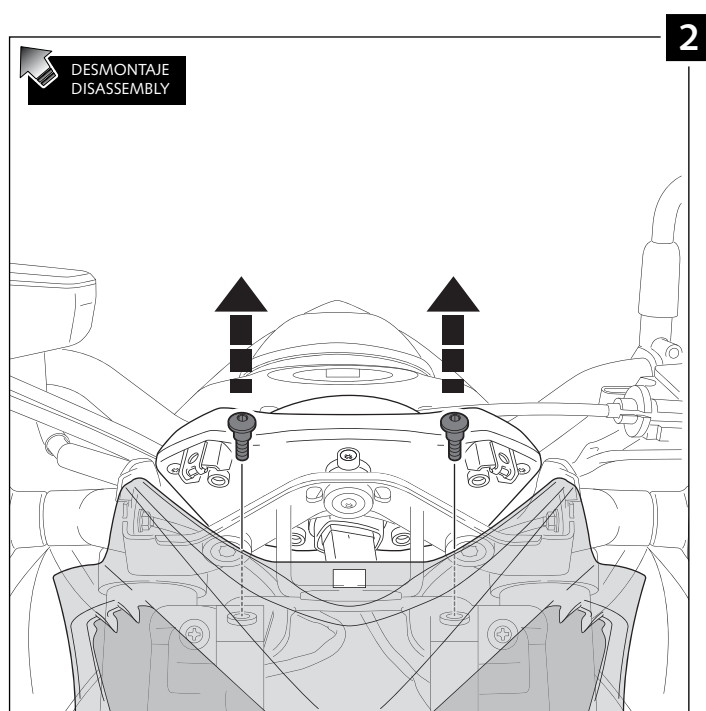
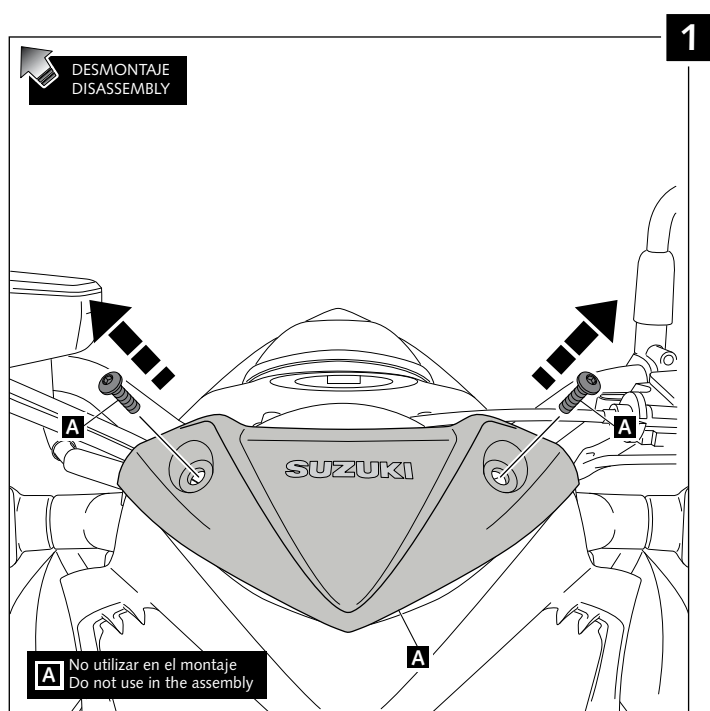

CARENABRÍS ADAPTABLE A - WINDSHIELD FOR - WINDSCHUTZSCHEIBE FÜR  
**SUZUKI GSX-S1000**

INSTRUCCIONES DE MONTAJE - MOUNTING INSTRUCTIONS - MONTAGEANLEITUNG

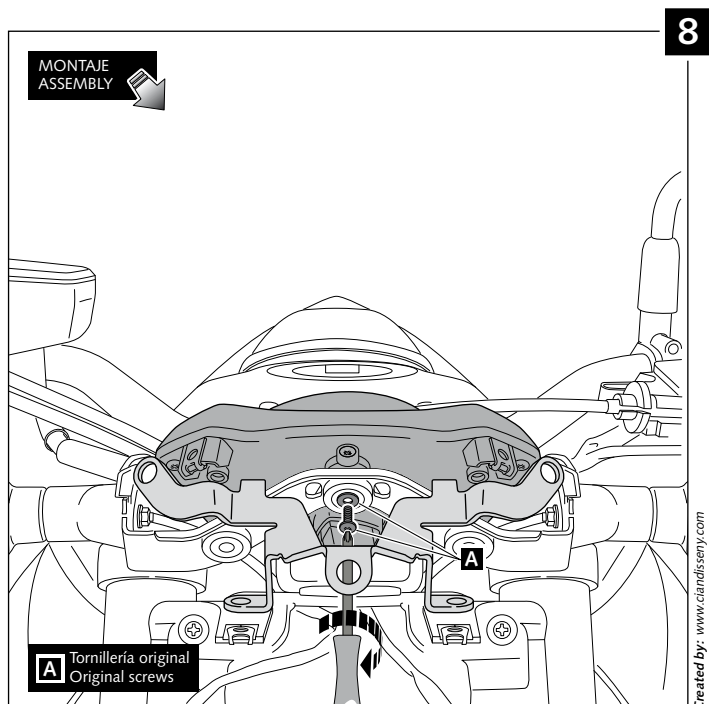
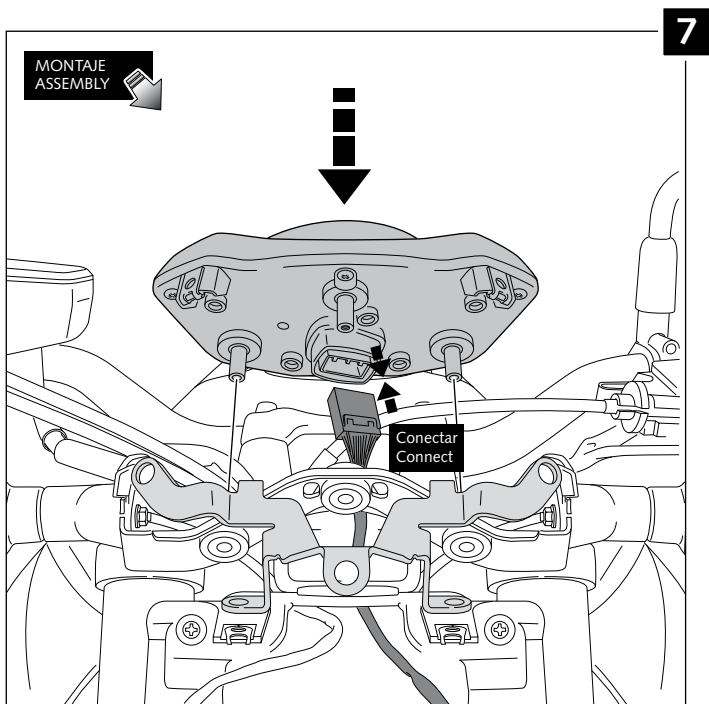
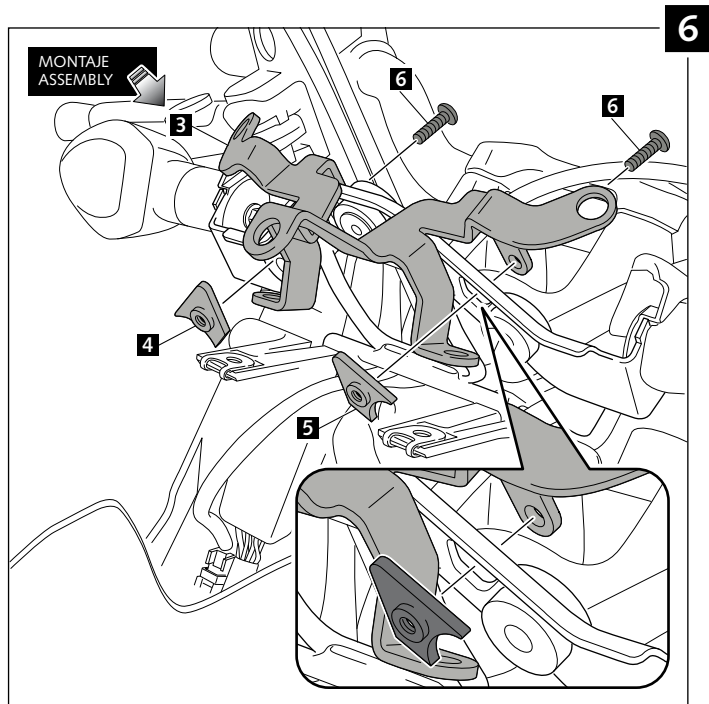
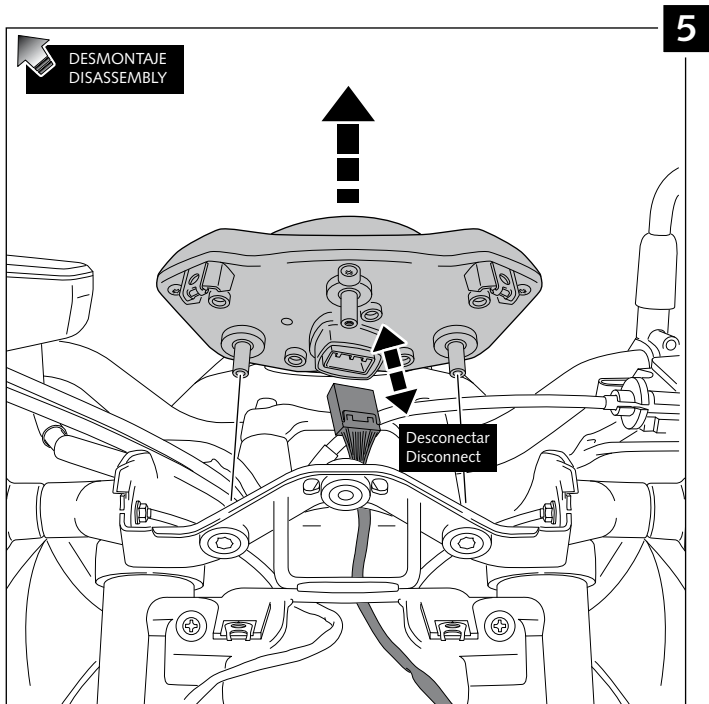

CARENABRÍS ADAPTABLE A - WINDSHIELD FOR - WINDSCHUTZSCHEIBE FÜR  
**SUZUKI GSX-S1000**

INSTRUCCIONES DE MONTAJE - MOUNTING INSTRUCTIONS - MONTAGEANLEITUNG

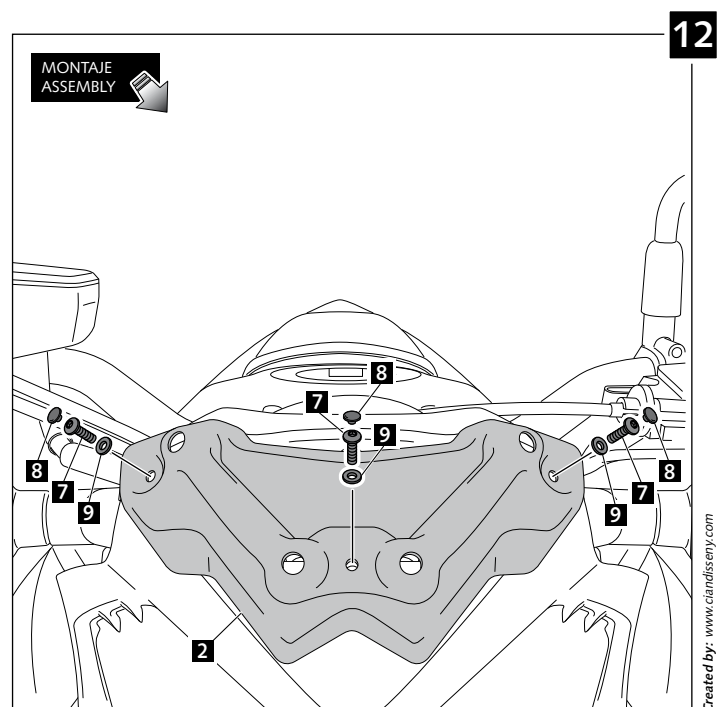
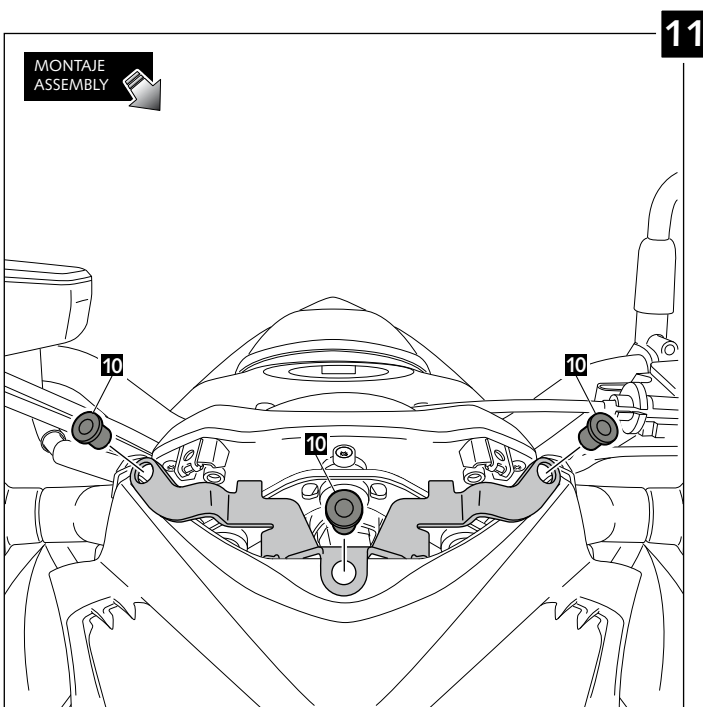
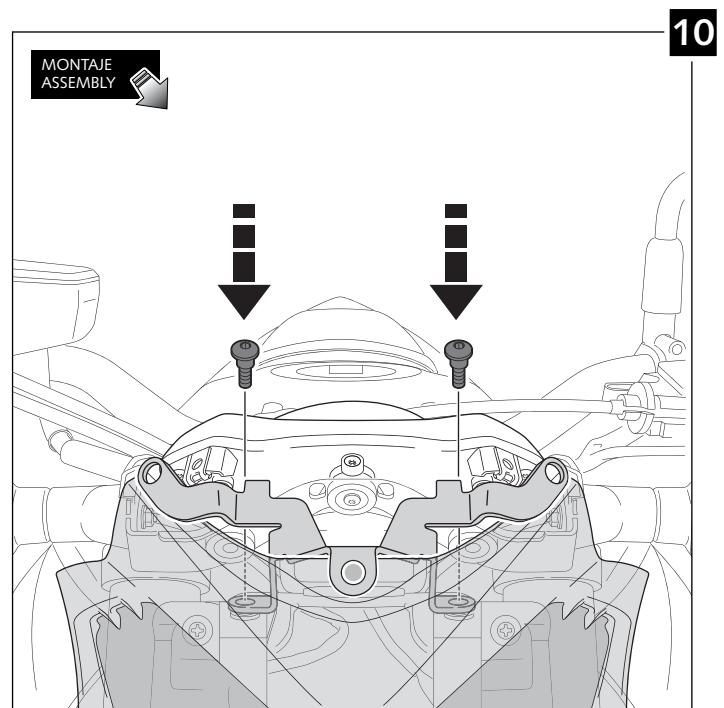
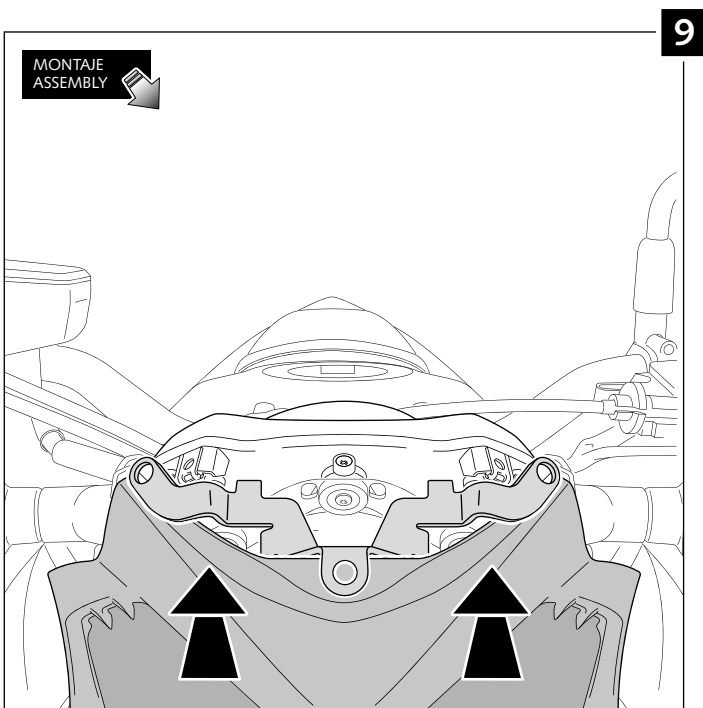

CARENABRÍS ADAPTABLE A - WINDSHIELD FOR - WINDSCHUTZSCHEIBE FÜR  
**SUZUKI GSX-S1000**

INSTRUCCIONES DE MONTAJE - MOUNTING INSTRUCTIONS - MONTAGEANLEITUNG

