



# YOSHIMURA

RESEARCH & DEVELOPMENT OF AMERICA, INC.

5420 DANIELS STREET STE A, CHINO CA., 91710 · (800) 634-9166 · (909) 628-4722 · FAX (909) 591-2198

[www.yoshimura-rd.com](http://www.yoshimura-rd.com)

## RACE SERIES

Qualified Manufacturer Declared "Modified Part"

2015~2017

**Yamaha R3**

**133200J220 (CF/CF)**

**133200J520 (SS/CF)**

**R-77 Stainless Steel Full-System**

**FOR CLOSED COURSE COMPETITION ONLY; NOT INTENDED FOR STREET USE**

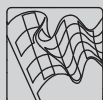

Race Series systems are:

- NOT CARB/EPA tail-pipe emissions compliant.
- NOT street legal.
- For "Closed Course Competition" use only.

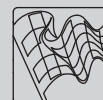

*You must know how to remove and replace your stock exhaust in order to install this product otherwise have it installed by a professional mechanic. Keep all stock parts from your existing system as some components may be necessary to install your new Yoshimura exhaust depending on the application. Read through all instructions before beginning installation. Exhaust system can be extremely hot. Let motorcycle cool down before beginning installation. Always wear hand and eye protection and take precautionary measures to avoid injury.*



NOTE: IN THE STATE OF CALIFORNIA, IT IS ILLEGAL TO MODIFY THE EMISSION CONTROL SYSTEM, WHICH INCLUDES THE CARBURETORS OF ANY VEHICLE.

## Assembly Diagram

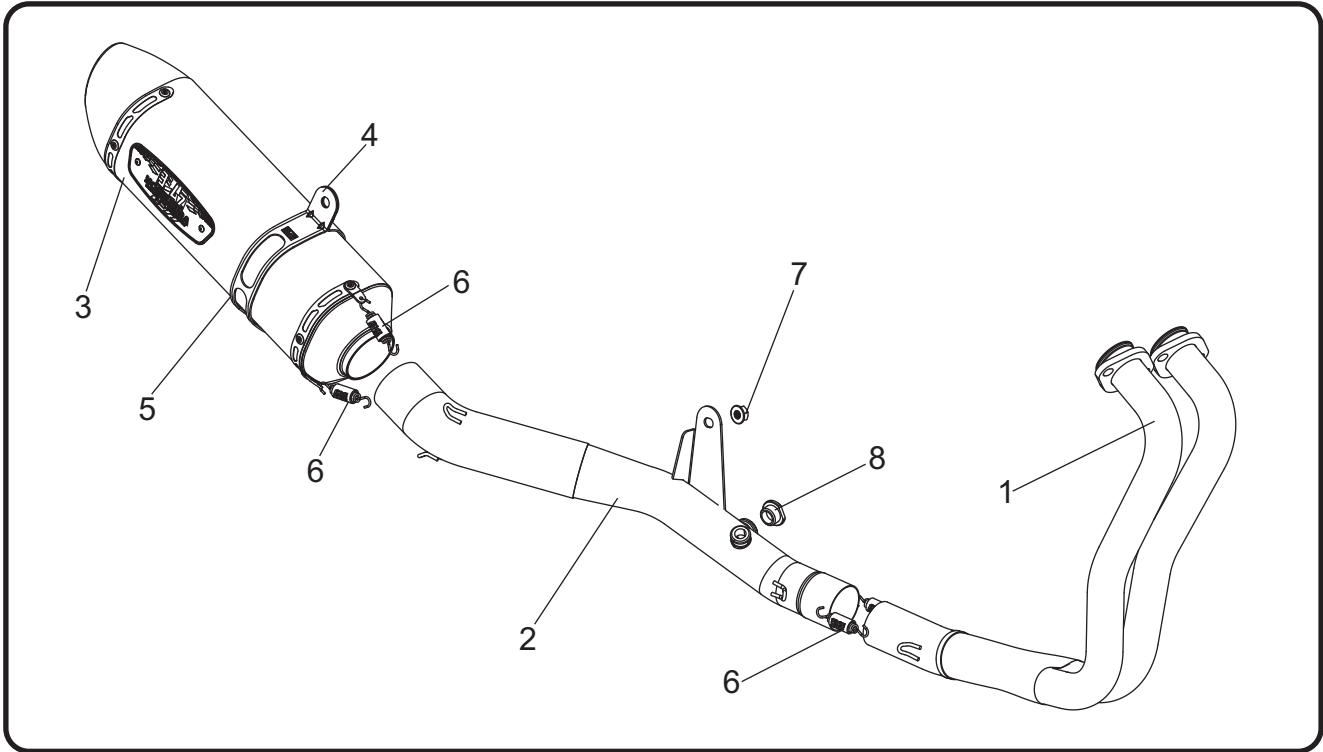

No.	Item	Description	Qty.
1	13320-401	Yoshimura Header	1
2	13320-419	Yoshimura Tailpipe	1
3	CRR77M12 SRR77M12	Carbon Fiber Muffler Stainless Steel Muffler	1
4	YM7M-MPCA(X)	Muffler Clamp	1
5	HT SHLDR77	Muffler Clamp Heatshield	1
6	RACE-SPS-1	Medium Spring	4
7	8MMNUT	8mm Flange Nut	1
8	M18X13PLG	O2 Sensor Plug	1
**	INS-04-K	Low Volume Insert	1
**	ST-200	Spring Puller Tool	1
**	17029	Sticker Kit Sheet	1

(X) Used for stainless steel muffler canister.  
 \*\* Not shown in diagram.

## Removal

1. Remove right lower cowl as per Factory Service / Owners Manual.
2. Loosen exhaust clamp and while securely supporting the stock muffler assembly, remove the muffler mount bolt. Carefully remove the stock muffler assembly.
3. Remove O2 sensor from the stock header.
4. Remove the header chassis mount bolt.

Note: It may be necessary to remove the two right rearset bolts to access chassis mount bolt.

5. While securely supporting the stock header, remove header nuts and carefully remove the stock header.

Note: The exhaust port gaskets will be re-used with the Yoshimura full-system exhaust. Inspect and replace if necessary.

## Installation

1. Install (No. 1) 13320-401, Yoshimura header using the stock header nuts. Do not torque at this time.

Note: Check to make sure header flanges are not overlapping when installing.

2. Install (No. 2) 13320-419, Yoshimura tailpipe onto (No. 1) 13320-401, header.
3. Secure (No. 2) 13320-419, tailpipe bracket to chassis using the stock chassis mount bolt and (No. 7) 8MMNUT, nut. Do not torque at this time.

Note: Tailpipe bracket mounts to the backside of chassis mount.

4. Install (No. 3) muffler onto (No. 2) 13320-419, tailpipe.
5. Install (No. 5) HT SHLDR77, muffler clamp heatshield onto (No. 4) YM7M-MPCA(X), muffler clamp.

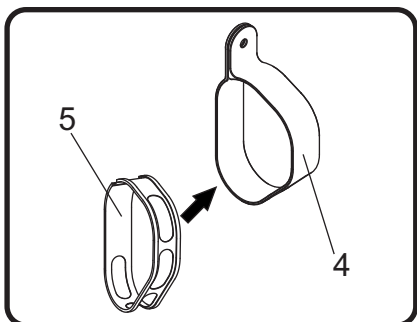

6. Slide (No. 4) YM7M-MPCA(X), muffler clamp over (No. 3) muffler. Secure muffler to the outside of the muffler mount using the stock bolt, washer, and nut.

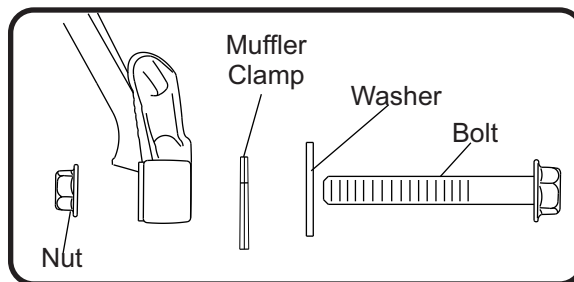

7. Install (No. 6) RACE-SPS-1, medium exhaust springs between muffler and tailpipe. Install (No. 6) RACE-SPS-1, medium exhaust springs between tailpipe and header.
8. Torque muffler mount bolt to factory specification. Torque tailpipe chassis mount bolt to factory specification. Torque header nuts to factory specification.
9. Re-install the stock O2 sensor into (No. 2) 13320-419, tailpipe.

Note: An additional O2 sensor bung is located on the tailpipe for performance tuning / mapping purposes. Install supplied O2 sensor plug if additional O2 sensor will not be used.

10. Before starting vehicle, check for proper clearance between new exhaust system and rear suspension (i.e. tire, control arm, brakes, rear shock, and etc.) If any problem is found, please carefully follow through the installation steps again. If problem still persists, please call Yoshimura Tech Department at (800) 634-9166 / in CA (909) 628-4722.
11. It is recommended that the muffler and tailpipe be wiped down with rubbing alcohol to remove oil and fingerprints. This will help prevent tarnishing of the finish after the exhaust is heated up.

Note: After starting vehicle, it is normal for new exhaust system and muffler to emit smoke until oil residue burns off.