



LP0192

FITTING INSTRUCTIONS FOR LP0192BK LICENCE PLATE BRACKET
KAWASAKI Z1000SX TOURER 2014-

Page



THIS KIT CONTAINS THE ITEMS PICTURED AND LABELLED BELOW.
DO NOT PROCEED UNTIL YOU ARE SURE ALL PARTS ARE PRESENT.

Please note that the way the kit is packed does not necessarily represent the way of mounting to the bike

THE PARTS SHOWN MAY BE REPRESENTATIVE ONLY (FOR CLARITY OF INSTRUCTIONS ONLY)

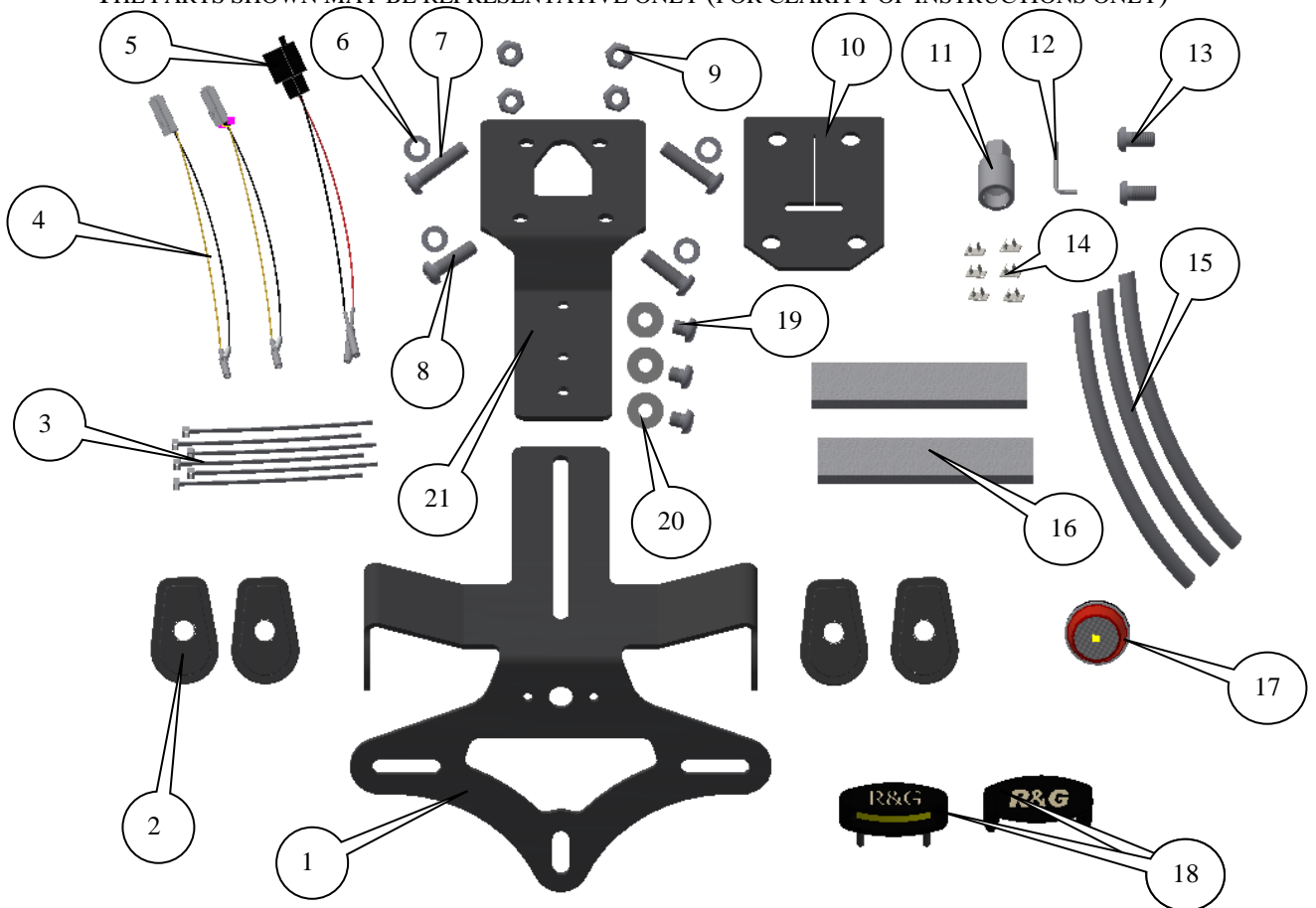

R&G Racing

Unit 1, Shelley's Lane, East Worldham, Alton, Hampshire, GU34 3AQ

Tel: +44 (0)1420 89007 Fax: +44 (0)1420 87301 www.rg-racing.com Email: info@rg-racing.com



LP0192

LEGEND

- ITEM 1 = MAIN MOUNTING BRACKET (TB0192BK-PART 1) (x1).
- ITEM 2 = MINI INDICATOR ADAPTORS (I0026) (x4).
- ITEM 3 = SMALL CABLE TIES (x6).
- ITEM 4 = INDICATOR CONNECTORS (CON0009) (x2).
- ITEM 5 = LICENCE PLATE ILLUMINATOR CONNECTOR (CON0007) (x1).
- ITEM 6 = M6x12mm WASHERS (x4).
- ITEM 7 = M6x25mm BUTTON HEAD BOLTS (x2).
- ITEM 8 = M6x20mm BUTTON HEAD BOLTS (x2).
- ITEM 9 = M6 NYLOC NUTS (x4).
- ITEM 10 = RUBBER GASKET (RG0015) (x1).
- ITEM 11 = TAMPER-PROOF BOLT REMOVAL TOOL (T0016) (x1).
- ITEM 12 = ALLEN KEY FOR BOLT REMOVAL TOOL (x1).
- ITEM 13 = M6x12mm BUTTON HEAD BOLTS (TO REPLACE TAMPER PROOF BOLTS) (x2).
- ITEM 14 = SELF ADHESIVE CABLE CLIPS (x6).
- ITEM 15 = 150mm LENGTHS OF HEAT SHRINK (x3).
- ITEM 16 = SELF-ADHESIVE NEOPRENE FOAM (x2).
- ITEM 17 = REFLECTOR (REFL 1) (x1).
- ITEM 18 = LICENCE PLATE ILLUMINATOR ASSEMBLY (LA0002) (x1).
- ITEM 19 = M6x6mm BUTTON HEAD BOLTS (x3).
- ITEM 20 = M6x16mm WASHERS (x3).
- ITEM 21 = INDICATOR/LICENCE PLATE MOUNTING BRACKET (TB0192BK-PART 2) (x1).

Page | 2

Please note that in cases where kits are packed with rubber washers holding the components onto the bolt – *the rubber washers should be thrown away!*

TOOLS REQUIRED

- Set of Metric Allen keys to include 3, 4, 5 and 6mm A/F.
 - 8, 10 and 12mm Socket and wrench.
 - Philips driver.
 - Electrical pliers/crimps.
 - Small amount of super glue.



PICTURE 1



PICTURE 2



LP0192

Page | 3



PICTURE 3

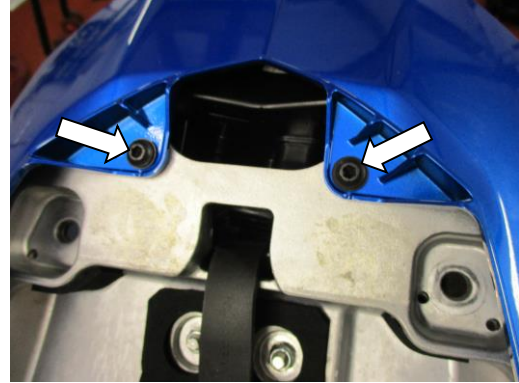

PICTURE 4

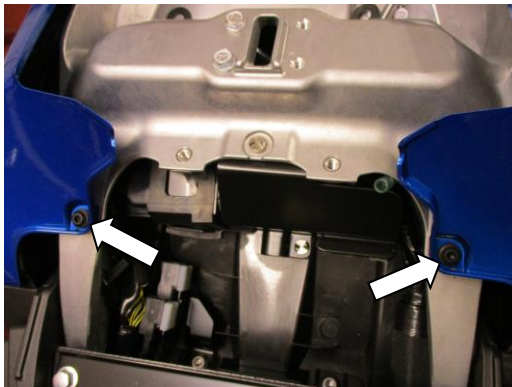

PICTURE 5

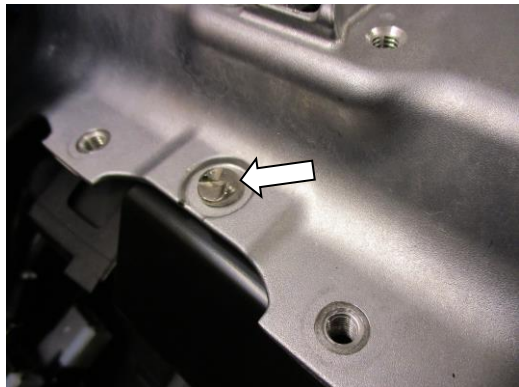

PICTURE 6



PICTURE 7

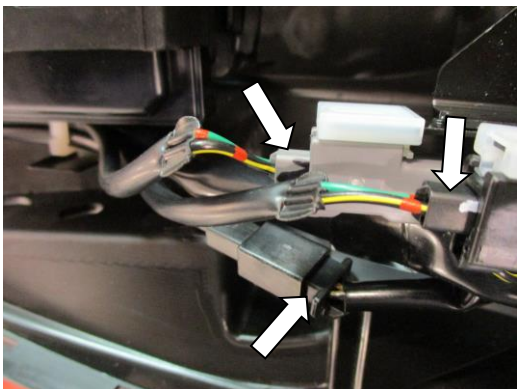

PICTURE 8



LP0192

Page | 4

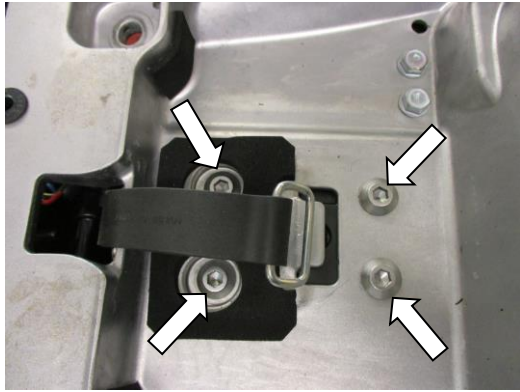

PICTURE 9

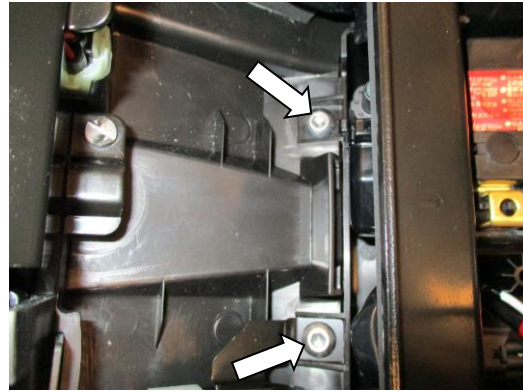

PICTURE 10



PICTURE 11

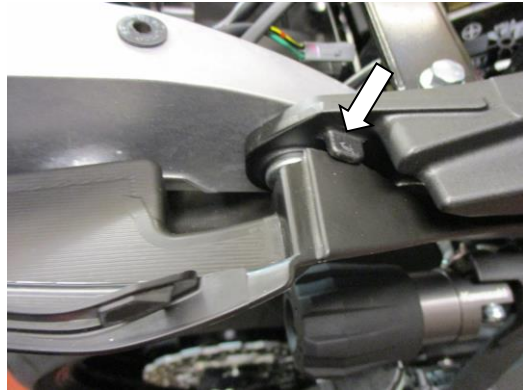

PICTURE 12

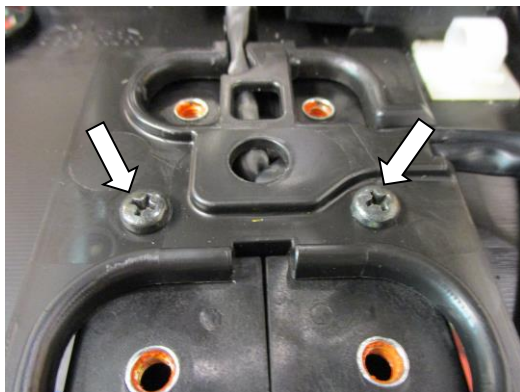

PICTURE 13

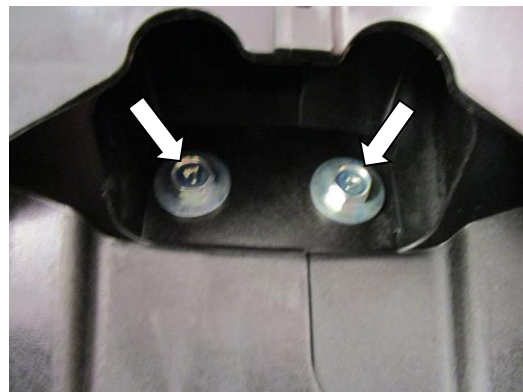

PICTURE 14



LP0192

Page | 5



PICTURE 15



PICTURE 16



PICTURE 17



PICTURE 18



PICTURE 19



PICTURE 20



LP0192

Page | 6



PICTURE 21



PICTURE 22



PICTURE 23



PICTURE 24



PICTURE 25



PICTURE 26



LP0192



PICTURE 27

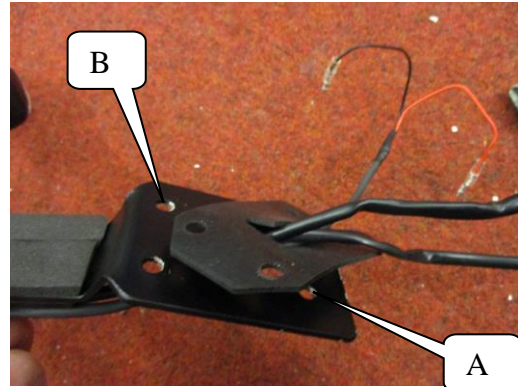

PICTURE 28



PICTURE 29

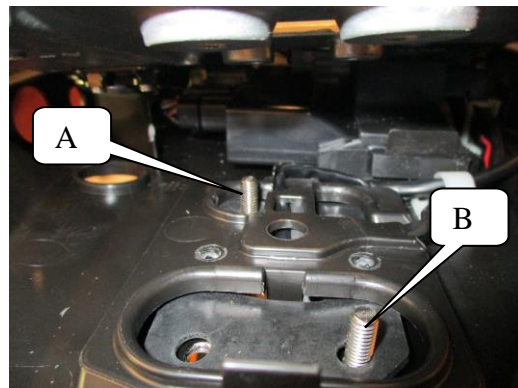

PICTURE 30

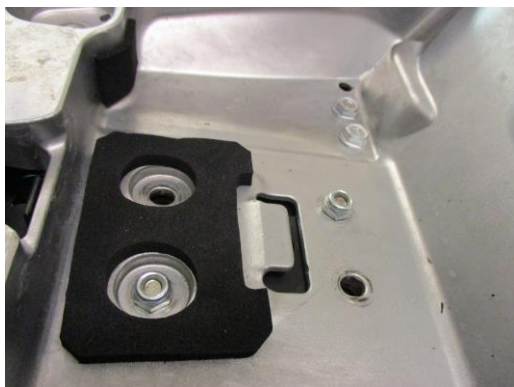

PICTURE 31

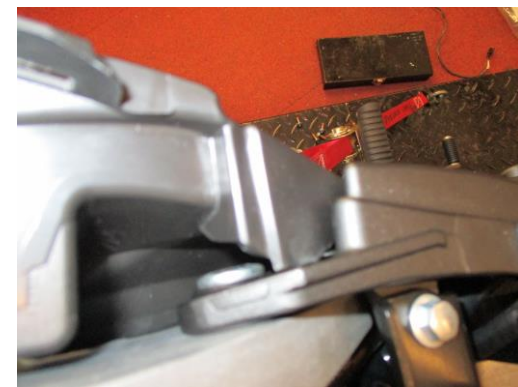

PICTURE 32



LP0192

Page | 8



PICTURE 33

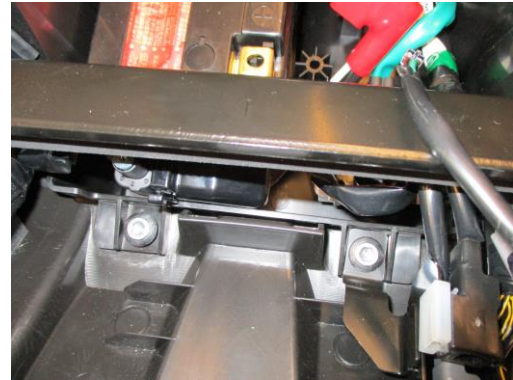

PICTURE 34

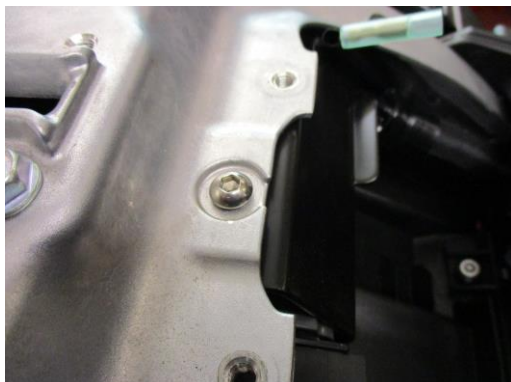

PICTURE 35



PICTURE 36

FITTING INSTRUCTIONS

PLEASE NOTE TO FIT THIS PRODUCT YOU WILL HAVE TO REMOVE A TAMPER-PROOF BOLT FOR WHICH A TOOL AND KEY IS SUPPLIED IN KIT (ITEMS 11 AND 12).

- Remove the panniers, rider and pillion seats.
- Remove the two bolts arrowed in picture 1.
- Remove the two bolts arrowed in pictures 2 and 3, then remove both pannier mounting brackets.
- Remove the four bolts arrowed in pictures 4 and 5.
- Carefully remove the rear sub-frame cowl.
- To remove the original licence plate bracket and access the wiring it is easier to achieve this by removing the tamper-proof bolt arrowed in picture 6.
- Remove the tamper-proof bolt use the tool provided (item 11), place the tool over the bolt head ensuring the locking screws are aligned with the thickest section of the bolt head and tighten the locking screws using the Allen key provided (item 12).
- Using a socket or spanner on the tool loosen and remove the bolt (if this fails the bolt may be removed by carefully drilling the head of the bolt).
- Disconnect the three wiring plug sockets arrowed in picture 8.

R&G Racing

Unit 1, Shelley's Lane, East Worldham, Alton, Hampshire, GU34 3AQ

Tel: +44 (0)1420 89007 Fax: +44 (0)1420 87301 www.rg-racing.com Email: info@rg-racing.com



LP0192

Page | 9

- Remove the four bolts arrowed in picture 9.
- Remove the two bolts arrowed in picture 10.
- Gently unclip the plastic under-tray from the location tabs shown in pictures 11 and 12 and gently lower the under-tray (you will have to feed the tool kit bungee through the slot in the rear sub-frame) until it rests on the rear wheel.
- With the under-tray lowered remove the two screws arrowed in picture 13.
- Carefully remove the wiring taking note of its routing.
- Carefully remove the original licence plate bracket while feeding all the wires through the holes in the under-tray.

If reusing the original indicators

- Remove the two bolts arrowed in picture 14 and remove the licence plate bolt bracket.
- Remove the nut arrowed in picture 15 and remove the reflector.
- Remove the three bolts arrowed in picture 16, the bracket can now be carefully separated into two halves.
- Remove the screw arrowed in picture 17 and then the clamp plate and the spreader plate.
- Then squeeze the rubber indicator stem to allow the indicator to be removed as shown in picture 18.
- Repeat the above to remove the other indicator (please note the relevant sides as they have drain holes which should point downwards on assembly).
- Fit the indicators to the indicator/licence plate mounting bracket (item 21) as shown in pictures 19, 20, 21 and 22 in the same manner as they were mounted originally (ensure they are fitted on the correct sides).

If using Mini indicators

- If using mini's fit the indicators of choice to the indicator/licence plate mounting bracket (item 21) (R&G mini indicator product code RG370 for bulb type and RG371 for LED type or RG372 for Aero Style led type) using the four indicator adaptors (item 2) (please use the provided heat shrink (item 15) to protect the wiring) as shown in the pictures below.



- Fit the new licence plate illuminator (item 18) to the new licence plate bracket (item 21) as shown in pictures 23 and 24 (please use the provided heat shrink (item 15) to protect the wiring).
- **PLEASE NOTE YOU WILL NEED TO GLUE THE LIGHT SHROUD TO THE LED LICENCE PLATE ILLUMINATOR USING SUPER GLUE.**
- Use the cable ties and clips (items 3 and 14) to neaten and tidy the wiring as shown in picture 25 ensuring to leave room around the slot for bolts and washers when fully assembled.

R&G Racing

Unit 1, Shelley's Lane, East Worldham, Alton, Hampshire, GU34 3AQ

Tel: +44 (0)1420 89007 Fax: +44 (0)1420 87301 www.rg-racing.com Email: info@rg-racing.com



LP0192

Page | 10

- Stick the self-adhesive neoprene foam (item 16) to the main mounting bracket (item 1) as shown in picture 26.
- Using the three short M6 button head bolts (item 19) with the larger washers (item 20) mount the main mounting bracket (item 1) to the indicator/licence plate bracket assembly as shown in picture 27 (position as far backwards as possible and do not tighten at this stage).
- Feed the wires through the central slot in the main bracket as shown in picture 28.
- Feed the wires through the slit in the rubber gasket (item 10) as shown in picture 28.
- Offer this assembly into position while feed the wires through the under-tray as original (shown in picture 29).
- Feed the wires through the under-tray cable guides and the sub-frame as original.
- Gently raise the under-tray into its original position.
- Place one of the longer M6 button head bolts (item 7) with one of the smaller M6 washers (item 6) through the hole marked 'A' and the rubber gasket as shown in pictures 28 and 30.
- Place one of the shorter M6 button head bolts (item 8) with one of the smaller M6 washers (item 6) through the hole marked 'B' and the rubber gasket as shown in pictures 28 and 30.
- Use two of the M6 nuts (item 9) to hold it in position as shown in picture 31 (do not tighten at this stage).
- Gently clip the plastic under-tray into over location tabs shown in pictures 11 and 12.
- Refit the two bolts shown in picture 34 as original.
- Use one of the M6 bolts (item 13) (or the original tamper-proof bolt if possible) as original shown in picture 35.
- Place the remaining longer M6 button head bolt (item 7) with one of the smaller M6 washers (item 6) through the remaining most forward hole and the rubber gasket as shown in picture 36 and secure using one of the M6 nuts (item 9).
- Place the remaining shorter M6 button head bolt (item 8) with one of the smaller M6 washers (item 6) through the remaining most rearward hole and the rubber gasket as shown in picture 36 and secure using one of the M6 nuts (item 9) and tighten the four nuts.
- Route the wiring as original.
- Connect the licence plate illuminator using the supplied wiring connector (item 5) to the original wiring plug socket.
- If using the original indicators connect the indicators to the original wiring plug sockets. It is a good idea to check the operation of the licence plate illuminator and indicators at this stage (if the licence plate illuminator fails to light please swap the bullet connectors over).
- If fitting the R&G Mini Indicators connect the indicators using the supplied wiring connectors (item 4) to the original wiring plug socket. Plug it into the loom to check at this stage (if illumination fails, swap the bullet connections around). (Please use the heat-shrink (item 15) to protect the new indicator wires). It is a good idea at this point to turn the ignition on and check for the correct operation of all lights.
- Refit the rear sub-frame cowl as original.
- Refit the pannier brackets as original.
- If using the panniers please fit them and position the indicator/licence plate bracket so the panniers can be removed without loosening the clamping bolts, tighten the three bolts securely.
- If not using panniers the bracket may be positioned further in to improve looks, please ensure all bolts are secure and no parts can contact or damage any part of the motorcycle.

R&G Racing

Unit 1, Shelley's Lane, East Worldham, Alton, Hampshire, GU34 3AQ

Tel: +44 (0)1420 89007 Fax: +44 (0)1420 87301 www.rg-racing.com Email: info@rg-racing.com



LP0192

Page | 11

- Re-fit the licence plate (it may require drilling).
- **IMPORTANT: IF FITTING A FULL-SIZE LICENCE PLATE AND PLACING IT FAR DOWN ON THE LICENCE PLATE HANGER, THERE IS A SMALL CHANCE OF THE LICENCE PLATE HITTING THE BACK WHEEL UNDER HEAVY LOAD AND OVER LARGE BUMPS IN THE ROAD. IT IS YOUR RESPONSIBILITY TO CHECK FOR THIS POSSIBILITY AND TAKE AVOIDING ACTION. FAILURE TO CHECK THIS COULD RESULT IN SERIOUS INJURY OR DAMAGE.**
- Refit both seats.
- Depending on local laws, attach enclosed red reflector (item 17) in an appropriate location.
- **Please test the indicators, rear light and licence plate illuminator before riding.**

Digital copies of these instructions are available to download from www.rg-racing.com

GENERAL TORQUE SETTINGS

M4 BOLT = 8Nm
M5 BOLT = 12Nm
M6 BOLT = 15Nm
M8 BOLT = 20Nm
M10 BOLT = 40Nm

ISSUE 1 11/03/2016 (NSY)

CONSUMER NOTICE

The catalogue description and any exhibition of samples are only broad indications of the Products and R&G may make design changes which do not diminish their performance or visual appeal and supplying them in such state shall conform to the order. The Buyer acknowledges no representation or warranty (other than as to title) has been given or will apply to the Products other than those in R&G's order or confirmation and the Buyer confirms it has chosen the Products as being of merchantable quality and suitable for its particular purposes. Where R&G fits the Products or undertakes other services it shall exercise reasonable skill and care and rectify any fault free of charge unless the workmanship has been disturbed. The Buyer is responsible for ensuring that the warranty on the motorcycle is not affected by the fitting of the Products. On return of any defective Products R&G shall at its option either supply a replacement or refund the purchase money but shall not be liable if the Products have been modified or used or maintained otherwise than in accordance with R&G's or manufacturer's instructions and good engineering practice or if the defect arises from accident or neglect. Other than identified above and subject to R&G not limiting its liability for causing death and personal injury, it shall not be liable for indirect or consequential loss and otherwise its liability shall be limited to the amounts paid by the Buyer for the Products or the fitting or service concerned. These terms do not affect the Buyer's statutory rights.

R&G RACING RETURNS POLICY (NON-FAULTY GOODS)

Returns must be pre-authorized (if not pre-authorized the return will be rejected). Goods may only be returned direct to us if they were purchased direct from us (customer must prove if necessary). Otherwise to be returned to original vendor. Goods must be in re-sellable condition, in the opinion of R&G Racing. All returns are subject to a 25% restocking and handling fee (25% of the gross value exc. P&P – at the prevailing price at time of purchase). The customer must pay any and all carriage charges. No returns of discontinued products, unless within 14 days of purchase. This policy does not affect your statutory rights and does not refer to faulty goods.

R&G Racing

Unit 1, Shelley's Lane, East Worldham, Alton, Hampshire, GU34 3AQ

Tel: +44 (0)1420 89007 Fax: +44 (0)1420 87301 www.rg-racing.com Email: info@rg-racing.com



LP0192

NOTICE DE MONTAGE POUR LP0192BK SUPPORT DE PLAQUE
KAWASAKI Z1000SX TOURER 2014-

Page | 12



Le kit contient les articles exposés ci-dessous, vérifier que toutes les pièces soient présentes avant de procéder au montage.

La façon dont le kit est emballé ne correspond pas forcément à la façon de monter les pièces sur la moto.

LES PARTIES PRESENTEES PEUVENT ETRE UNIQUEMENT REPRESENTATIVES (POUR LA CLARTE DES INSTRUCTIONS UNIQUEMENT)

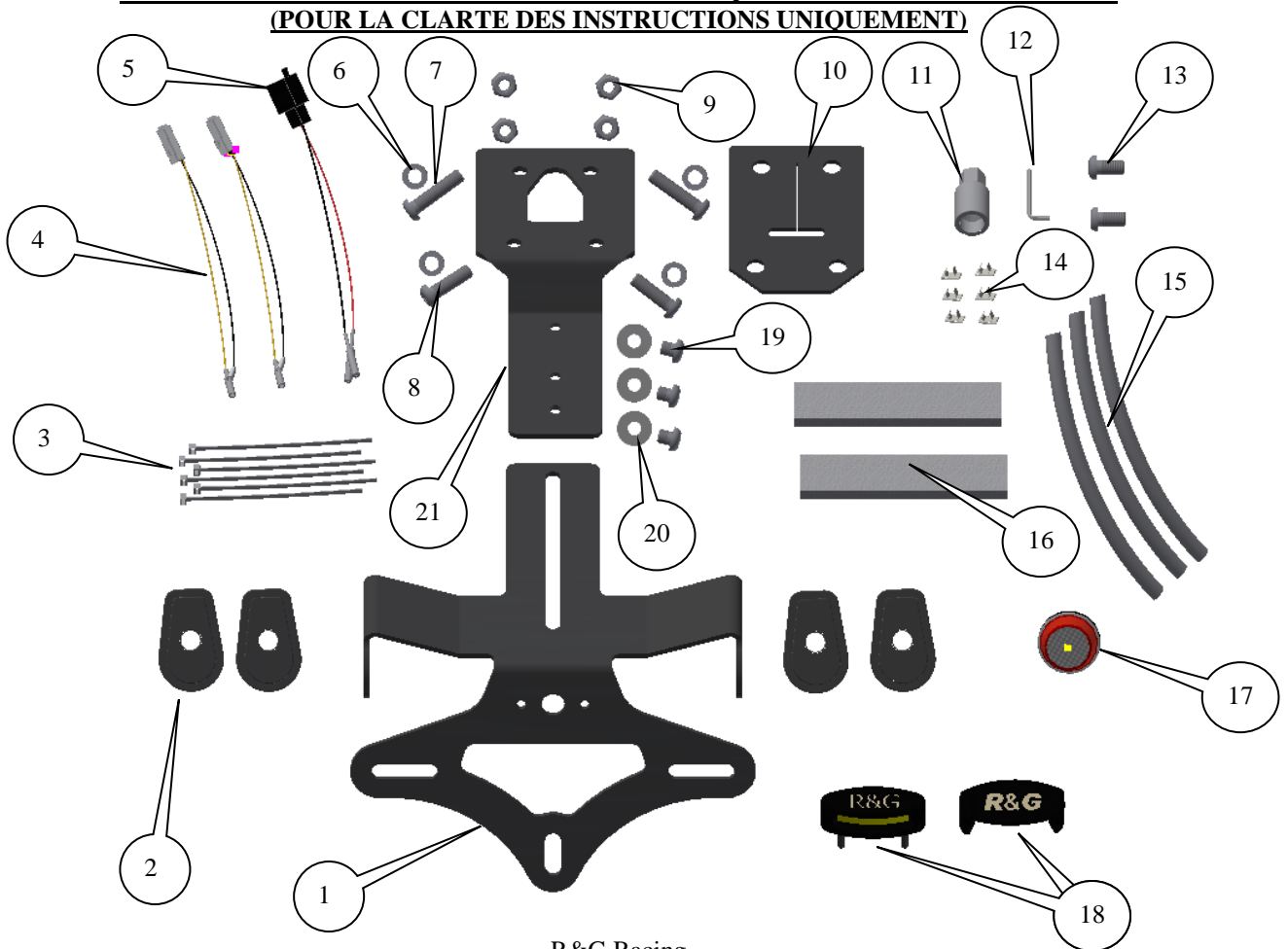

R&G Racing

Unit 1, Shelley's Lane, East Worldham, Alton, Hampshire, GU34 3AQ

Tel: +44 (0)1420 89007 Fax: +44 (0)1420 87301 www.rg-racing.com Email: info@rg-racing.com



LP0192

LEGENDE

- ARTICLE 1 = SUPPORT DE PLAQUE PRINCIPAL (TB0192BK-PART 1) (x1).
ARTICLE 2 = ADAPTATEURS MINI CLIGNOTANTS (I0026) (x4).
ARTICLE 3 = PETITS COLLIERS DE SERRAGE (x6).
ARTICLE 4 = CONNECTEURS CLIGNOTANTS (CON0009) (x2).
ARTICLE 5 = CONNECTEUR FEU DE PLAQUE (CON0007) (x1).
ARTICLE 6 = M6x12mm RONDELLES (x4).
ARTICLE 7 = M6x25mm BOULONS (x2).
ARTICLE 8 = M6x20mm BOULONS (x2).
ARTICLE 9 = M6 ECROUS (x4).
ARTICLE 10 = JOINT EN CAOUTCHOUC (RG0015) (x1).
ARTICLE 11 = OUTIL POUR EXTRAIRE LE BOULON INVOLABLE (T0016) (x1).
ARTICLE 12 = CLE ALLEN POUR L'OUTIL (x1).
ARTICLE 13 = M6x12mm BOULONS (POUR REMPLACER LES BOULONS INVOLABLES) (x2).
ARTICLE 14 = CLIPS AUTOCOLLANTS (x6).
ARTICLE 15 = 150mm LONGUEURS DE THERMO RETRACTABLE (x3).
ARTICLE 16 = MOUSSE NEOPRENE AUTOCOLLANTE (x2).
ARTICLE 17 = REFLECTEUR (REFL 1) (x1).
ARTICLE 18 = ASSEMBLAGE FEU DE PLAQUE (LA0002) (x1).
ARTICLE 19 = M6x6mm BOULONS (x3).
ARTICLE 20 = M6x16mm RONDELLES (x3).
ARTICLE 21 = SUPPORT DE FIXATION CLIGNOTANT / FEU DE PLAQUE (TB0192BK-PART 2) (x1).

Page | 13

Notez que si les kits sont emballés avec des rondelles en caoutchouc servant à tenir les composants, *ces rondelles doivent être jetées !*

OUTILS REQUIS

- Jeu de clés Allen 3, 4, 5 et 6mm.
- Clé à douille 8, 10 and 12mm.
 - Tournevis cruciforme.
 - Pincés électriques
 - Un peu de superglue

NOTICE DE MONTAGE

POUR MONTER CE PRODUIT, VOUS DEVREZ ENLEVER LE BOULON INVOLABLE CHAQUE OUTIL ET CLE FOURNIE DANS LE KIT (ARTICLES 11 ET 12).

- Enlever les sacoches, les sièges pilote et passager.
- Enlever les 2 boulons indiqués sur la photo 1.
- Enlever les 2 boulons indiqués sur les photos 2 et 3, puis les 2 supports de sacoche.
- Enlever les 4 boulons, voir photos 4 et 5.
- Enlever le capot de siège arrière.
- Pour enlever le support de plaque d'origine et accéder aux fils, vous pouvez enlever le boulon inviolable, voir photo 6.
- Utiliser l'outil fourni pour enlever le boulon inviolable (article 11), placer l'outil sur la tête du boulon en veillant à ce que les vis de blocage soient alignées avec la section la

R&G Racing

Unit 1, Shelley's Lane, East Worldham, Alton, Hampshire, GU34 3AQ

Tel: +44 (0)1420 89007 Fax: +44 (0)1420 87301 www.rg-racing.com Email: info@rg-racing.com



LP0192

plus mince de la tête du boulon et serrer les vis de blocage en utilisant la clé Allen fournie (article 12).

- Utiliser une clé sur l'outil et enlever le boulon (Si cela échoue, le boulon peut être enlevé en perçant la tête du boulon).
- Déconnecter les 3 prises de fil, voir photo 8.
- Enlever les 4 boulons, voir photo 9.
- Enlever les 2 boulons, voir photo 10.
- Déclipser le passage de roue en plastique de son emplacement, voir photos 11 et 12 puis baisser le passage de roue (Vous devrez passer l'outil du kit dans la fente à l'arrière du passage de roue) jusqu'à ce qu'il se retrouve sur la roue arrière.
- Une fois le passage de roue baissé, enlever les 2 vis, voir photo 13.
- Enlever les fils en prenant note de leur organisation.
- Enlever le support de plaque d'origine tout en passant les fils dans les trous du passage de roue.

Si vous réutilisez les clignotants d'origine.

- Enlever les 2 boulons, voir photo 14 et enlever le support de plaque.
- Enlever l'écrou, voir photo 15 et enlever le réflecteur.
- Enlever les 3 boulons, voir photo 16, le support peut maintenant être séparé en 2 moitiés.
- Enlever la vis, voir photo 17 puis la plaque d'attache et la plaque d'écartement.
- Ensuite, presser la tige de clignotant en caoutchouc pour permettre au clignotant d'être enlevé, voir photo 18.
- Répéter la procédure ci dessus pour enlever l'autre clignotant (Notez les cotés car ils possèdent des trous d'évacuation qui pointent vers le bas sur l'assemblage).
- Monter les clignotants sur le support de fixation clignotant/plaque (article 21), voir photos 19, 20, 21 et 22 de la même façon qu'ils ont été enlevés à l'origine (Assurez vous qu'ils soient montés du bon côté).

Si vous utilisez les mini clignotants.

- Si vous utilisez des mini clignotants, monter les clignotants de votre choix sur le support de fixation clignotant (article 21) (Code RG370 pour type ampoule et RG371 pour type LED et RG372 pour LED latérale) en utilisant les 4 adaptateurs de clignotants (article 2) (Utiliser la thermo rétractable fournie) (article 15) pour protéger les fils, voir ci-dessous



- Monter le support de clignotant (article 18) sur le nouveau support principal (article 21, voir photos 23 et 24 (Utiliser la thermo rétractable fournie (article 15) pour protéger les fils).
- **VOUS DEVREZ COLLER LE LINCEUL AU FEU DE PLAQUE LED EN UTILISANT LA SUPER GLUE.**

R&G Racing

Unit 1, Shelley's Lane, East Worldham, Alton, Hampshire, GU34 3AQ

Tel: +44 (0)1420 89007 Fax: +44 (0)1420 87301 www.rg-racing.com Email: info@rg-racing.com



LP0192

Page | 15

- Utiliser les colliers et clips (articles 3 et 14) pour organiser et serrer les fils ensemble, voir photo 25 en veillant à laisser l'espace autour de la fente pour les boulons et rondelles lorsqu'ils seront assemblés.
- Coller la mousse néoprène autocollante (article 16) sur le support de fixation principal (article 1), voir photo 26.
- Utiliser les 3 boulons M6 (article 19) avec les rondelles les plus larges (article 20) pour monter le support de fixation principal (article 1) sur le support clignotant / plaque, voir photo 27 (positionner aussi loin que possible et ne pas serrer à ce stade).
- Passer les fils dans la fente centrale du support principal, voir photo 28.
- Passer les fils dans la fente du joint en caoutchouc (article 10), voir photo 28.
- Monter l'ensemble en position tout en passant les fils dans le passage de roue (voir photo 29).
- Passer les fils dans les guides du passage de roue et le sous-cadre comme à l'origine.
- Elever doucement le passage de roue dans sa position d'origine.
- Insérer un des boulons M6 (article 7) avec une des rondelles M6 (article 6) dans le trou marqué 'A' et le joint en caoutchouc, voir photos 28 et 30.
- Placer un des boulons M6 (article 8) avec une des rondelles M6 (article 6) dans le trou marqué « B » et le joint, voir photos 28 et 30.
- Utiliser 2 des écrous M6 (article 9) pour tenir la position, voir photo 31 (ne pas serrer à ce stade).
- Clipser le passage de roue dans les onglets, voir photos 11 et 12.
- Réinsérer les 2 boulons, voir photo 34 comme à l'origine.
- Utiliser un des boulons M6 (article 13) (ou le boulon inviolable d'origine si possible) voir photo 35.
- Placer le boulon restant M6 (article 7) avec une des rondelles M6 (article 6) dans le trou restant le plus en avant et le joint en caoutchouc, voir photo 36 puis fixer à l'aide d'un des écrous M6 (article 9).
- Placer le boulon M6 restant (article 8) avec une des rondelles M6 (article 6) dans le trou le plus reculé et le joint en caoutchouc, voir photo 36 et fixer à l'aide d'un écrou M6 (article 9) puis serrer les 4 écrous.
- Router les fils comme à l'origine.
- Connecter le feu de plaque en utilisant le connecteur fourni (article 5) à la prise d'origine.
- Si vous utilisez les clignotants d'origine, connecter les clignotants à la prise d'origine. Il est bon de vérifier qu'à ce stade le feu de plaque fonctionne correctement (si ce n'est pas le cas, tournez les connecteurs).
- Si vous monter les mini clignotants R&G, connectez les clignotants en utilisant les connecteurs fournis (article 4) à la prise d'origine. Branchez le dans le lincau pour vérifier le bon fonctionnement à ce stade (Si l'éclairage échoue, tournez les connecteurs). (Svp, utilisez une gaine thermo rétractable (article 15) pour protéger les fils de nouveaux clignotants). Mettez le contact et vérifiez le fonctionnement des feux.
- Remonter le capot de sous cadre arrière comme à l'origine.
- Remonter les supports sacoche comme à l'origine.
- Si vous utilisez les sacs, montez les et positionnez le support de plaque/clignotant de façon à ce que les sacs puissent être enlevés sans desserrer les boulons, serrer les 3 boulons.
- Si vous n'utilisez pas les sacs, le support de sacs peut être positionné plus loin pour améliorer l'esthétique, veiller à ce que tous les boulons soient fixés et qu'aucune partie ne puisse entrer en contact ou abimer une autre partie de la moto.
- Remettre la plaque d'immatriculation (Peut nécessiter un perçage).

R&G Racing

Unit 1, Shelley's Lane, East Worldham, Alton, Hampshire, GU34 3AQ

Tel: +44 (0)1420 89007 Fax: +44 (0)1420 87301 www.rg-racing.com Email: info@rg-racing.com



LP0192

- **IMPORTANT: Si vous installez une grosse plaque, il y a un risque que la plaque entre en contact avec la roue arrière en cas de choc sur la route (bosse, grosse charge etc...). Il est de votre responsabilité de vérifier que cela ne puisse pas se produire. Ne pas effectuer ces vérifications peut entraîner des dommages ainsi que des blessures graves pour le pilote.**
- Remettre les 2 sièges.
- Selon la loi locale, attachez le réflecteur (article 13) fourni à son emplacement approprié
- **Vérifiez que les clignotants et les feux de plaque fonctionnent bien avant de prendre la route.**

Page | 16

Notice disponible sur www.rg-racing.com

COUPLES DE SERRAGE RECOMMANDÉS :

M4 BOULON = 8Nm
M5 BOULON = 12Nm
M6 BOULON = 15Nm
M8 BOULON = 20Nm
M10 BOULON = 40Nm

ISSUE 1 11/03/2016 (NSY)

CONSUMER NOTICE

The catalogue description and any exhibition of samples are only broad indications of the Products and R&G may make design changes which do not diminish their performance or visual appeal and supplying them in such state shall conform to the order. The Buyer acknowledges no representation or warranty (other than as to title) has been given or will apply to the Products other than those in R&G's order or confirmation and the Buyer confirms it has chosen the Products as being of merchantable quality and suitable for its particular purposes. Where R&G fits the Products or undertakes other services it shall exercise reasonable skill and care and rectify any fault free of charge unless the workmanship has been disturbed. The Buyer is responsible for ensuring that the warranty on the motorcycle is not affected by the fitting of the Products. On return of any defective Products R&G shall at its option either supply a replacement or refund the purchase money but shall not be liable if the Products have been modified or used or maintained otherwise than in accordance with R&G's or manufacturer's instructions and good engineering practice or if the defect arises from accident or neglect. Other than identified above and subject to R&G not limiting its liability for causing death and personal injury, it shall not be liable for indirect or consequential loss and otherwise its liability shall be limited to the amounts paid by the Buyer for the Products or the fitting or service concerned. These terms do not affect the Buyer's statutory rights.

R&G RACING RETURNS POLICY (NON-FAULTY GOODS)

Returns must be pre-authorized (if not pre-authorized the return will be rejected). Goods may only be returned direct to us if they were purchased direct from us (customer must prove if necessary). Otherwise to be returned to original vendor. Goods must be in re-sellable condition, in the opinion of R&G Racing. All returns are subject to a 25% restocking and handling fee (25% of the gross value exc. P&P – at the prevailing price at time of purchase). The customer must pay any and all carriage charges. No returns of discontinued products, unless within 14 days of purchase. This policy does not affect your statutory rights and does not refer to faulty goods.

R&G Racing

Unit 1, Shelley's Lane, East Worldham, Alton, Hampshire, GU34 3AQ

Tel: +44 (0)1420 89007 Fax: +44 (0)1420 87301 www.rg-racing.com Email: info@rg-racing.com