











A5608A - A5608A

ATTACCHI SPECIFICI PER - SPECIFIC FITTING KIT FOR - KIT DE MONTAGE SPECIFIQUE POUR
 SPEZIFISCHER MONTAGEKIT FÜR - ANCLAJE ESPECÍFICO PARA - ANCORADOURO ESPECÍFICO

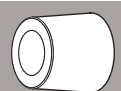
PIAGGIO VESPA PRIMAVERA 50-125 (2014)

N°	Descrizione	Caratteristiche	Codice	Quantità	
1	Supporto - Support - Support Halterung - Soporte - Apoio	-	5608ADX 5608ASX	2 (Dx;Sx)	
2	Vite - Screw Vis - Schraube Tornillo - Parafuso	TBEI M6x25	625TBEI	4	
3	Vite - Screw Vis - Schraube Tornillo - Parafuso	TCEI M8x80	880TCEI	2	
4	Rondella - Washer Rondelle - Scheibe Arandela - Arruela	Ø20 Foro 8mm	820RON	2	
5	Rondella - Washer Rondelle - Scheibe Arandela - Arruela	Ø8	8RON	2	
6	Cono	-	V568	2	
7	Fisher	-	V410	2	
8	Fascetta - Clamp Collier - Schelle Abrazadera - Braçadeira	-	Z4861	4	
9	Boccola Di Ritenzione - Plastic Bush Douille Plastique - Plastik Buchse Casquillo - Concha	-	Z4862	4	
10	Gommino - Fairleader Chaumard - Gummi Goma - Borracha	-	Z4860	4	
11	-	-	-	-	

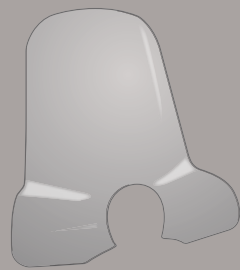
A5608A - A5608A

ATTACCHI SPECIFICI PER - SPECIFIC FITTING KIT FOR - KIT DE MONTAGE SPECIFIQUE POUR
SPEZIFISCHER MONTAGEKIT FÜR - ANCLAJE ESPECÍFICO PARA - ANCORADOURO ESPECÍFICO

PIAGGIO VESPA PRIMAVERA 50-125 (2014)

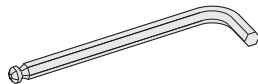
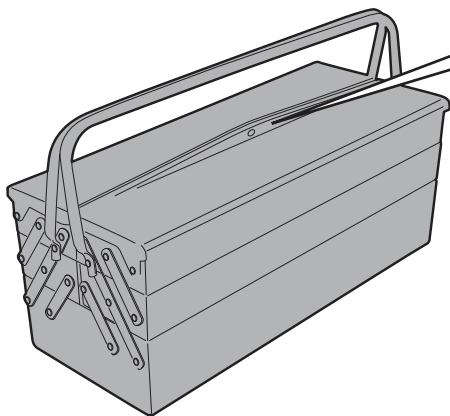

4mm - 6mm



A5608A - A5608A

ATTACCHI SPECIFICI PER - SPECIFIC FITTING KIT FOR - KIT DE MONTAGE SPECIFIQUE POUR
SPEZIFISCHER MONTAGEKIT FÜR - ANCLAJE ESPECÍFICO PARA - ANCORADOURO ESPECÍFICO

PIAGGIO **VESPA PRIMAVERA 50-125** (2014)

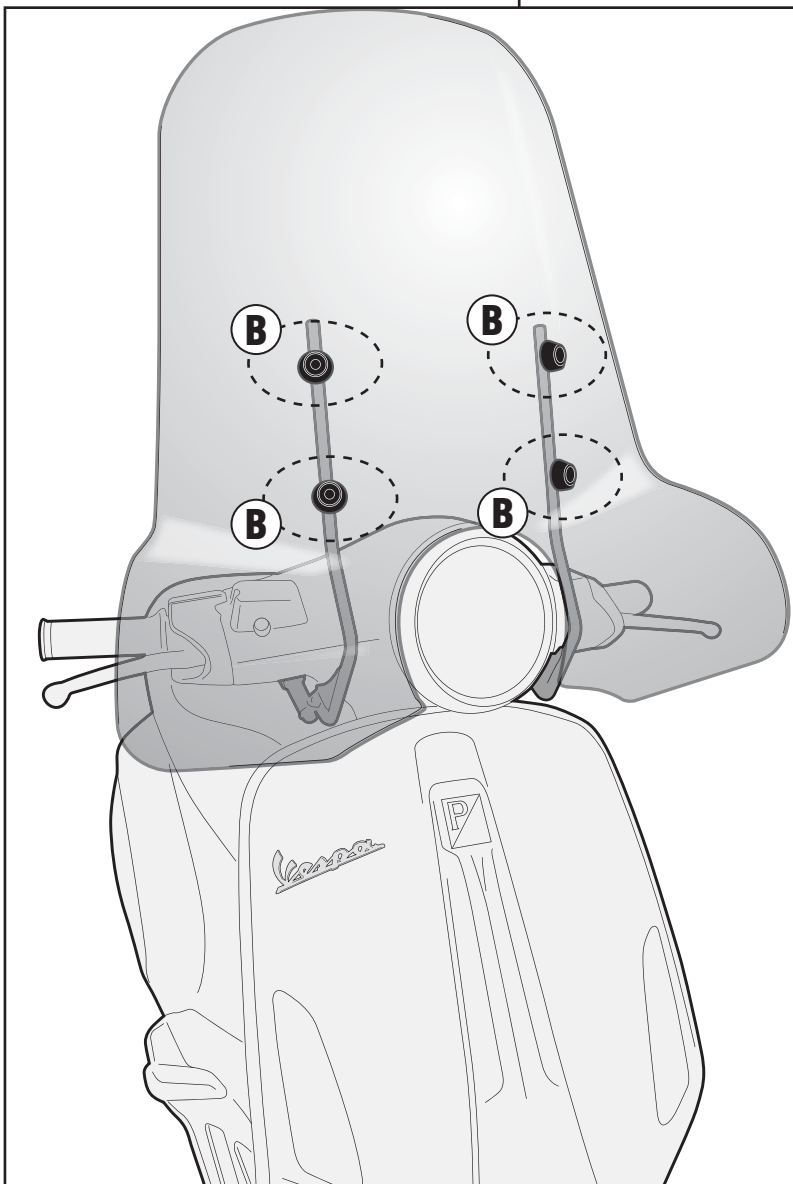
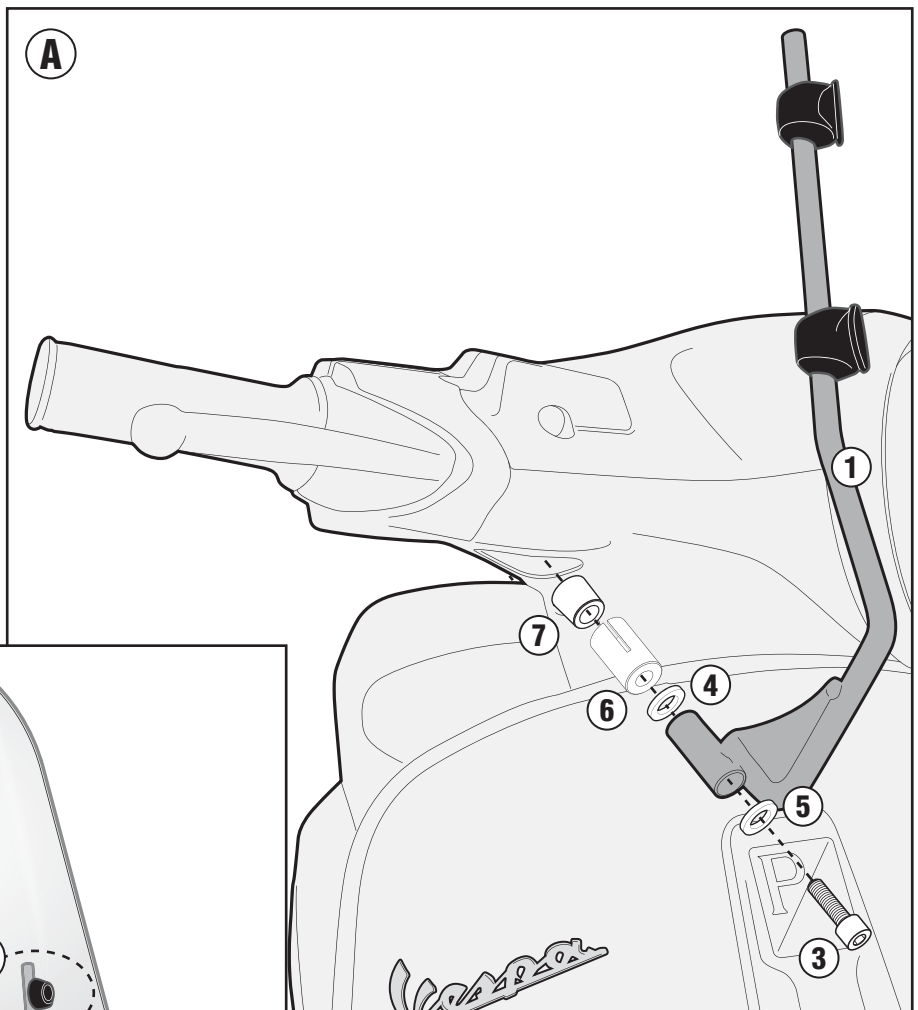

A5608A - A5608A

ATTACCHI SPECIFICI PER - SPECIFIC FITTING KIT FOR - KIT DE MONTAGE SPECIFIQUE POUR
SPEZIFISCHER MONTAGEKIT FÜR - ANCLAJE ESPECÍFICO PARA - ANCORADOURO ESPECÍFICO

PIAGGIO VESPA PRIMAVERA 50-125 (2014)

