

Item number: **FBL.01.529.10000**

Revision: **00** · Date: **09 - 2023**

## Brake pedal

 ~ 1 h.

EASY  DIFFICULT

**ENGLISH** Thank you for choosing this premium product from SW-MOTECH. Visit our online shop for more information (e.g. model assignments). Required documents (e.g. national type approval) are available there for you to download.

Please read and understand all the instructions, safety information and warnings in these mounting instructions before mounting and using the product in order to avoid injury and damage. Keep these mounting instructions for reference.

This product was developed for vehicles in factory condition. Compatibility with original accessories or accessories from other manufacturers cannot be guaranteed.

These mounting instructions have been prepared to the best of our current knowledge. No legal claims relating to accuracy can be made. Errors and omissions excepted. We reserve the right to make technical and design changes. The copyright is held by SW-MOTECH.

### SAFETY WARNING SYMBOL

 This warning symbol is used in these mounting instructions to warn of deadly dangers, injuries or other hazards. The words **DANGER**, **WARNING** or **CAUTION** are used as part of this warning symbol to convey important safety messages and information relating to the installation and use of this product. These words, together with the safety warning symbol, mean:

 **DANGER:** Indicates a hazardous situation which, if not avoided, will result in death or serious injury!

 **WARNING:** Indicates a hazardous situation which, if not avoided, may result in death or serious injury!

 **CAUTION:** Indicates a hazardous situation which, if not avoided, may result in minor or moderate injury!

 **NOTE:** Important information, but not relating to a risk of death or injury (property damage only)!

### GENERAL INFORMATION

 **WARNING:** Assembly and/or maintenance of this product requires advanced technical skill, appropriate tools, and a good understanding of tool usage and torque specifications. For your own safety, SW-MOTECH recommends having the assembly and/or maintenance carried out by a qualified and certified motorcycle workshop.

 **WARNING:** If you do choose to assemble this product yourself, carefully and fully read the mounting instructions before assembly and use, and follow all instructions to avoid serious injury or death. Also observe all relevant information in the vehicle manual when mounting or using the product. IF YOU DO NOT UNDERSTAND ANY PART OF THESE MOUNTING INSTRUCTIONS OR NEED AN EXPLANATION AS TO A SPECIFIC INSTRUCTION, DO NOT ATTEMPT TO INSTALL THIS PRODUCT WITHOUT CONSULTING SW-MOTECH FOR ASSISTANCE!

**PREPARATION:** Read the mounting instructions carefully and make sure that all parts on the parts list are available.

 **CAUTION:** Ensure that your vehicle is standing securely. Switch off the engine and remove the ignition key. Allow the engine/exhaust to cool down if necessary. Disconnect the battery when working on the electrical system. Only use proper tools and always wear safety goggles and gloves during assembly and maintenance. Have a second person help you with assembly and maintenance.

**ASSEMBLY:** All parts and connections removed from the vehicle must be reinstalled according to the vehicle manufacturer's specifications or replaced with parts and hardware supplied by SW-MOTECH.

 **WARNING:** Secure all threads with a medium-strength liquid threadlocker, unless otherwise specified.

 **DANGER:** Tightening torques not defined by SW-MOTECH must be obtained from the vehicle manufacturer or a certified motorbike workshop.

**FUNCTIONAL CHECK:** After mounting the product, ensure that no moving parts are obstructed and that the function of the vehicle is not impeded. Cables and hoses must not rub against each other and/or be hindered in any way.

 **WARNING:** Carry out a comprehensive functionality check before you start to drive. Check the tightening torque of all connections and the tight fit of the product after the first 50 km and then at regular intervals. Mounted accessories can change the handling and stability of the vehicle.



SW-MOTECH GmbH & Co. KG  
Ernteweg 7-10  
35282 Rauschenberg  
Germany



 [info@sw-motech.com](mailto:info@sw-motech.com)  
 [www.sw-motech.com](http://www.sw-motech.com)



Take note of the symbols and what they mean in the ASSEMBLY section. If the term OEM appears in the ASSEMBLY section, the vehicle manufacturer's specifications must be observed and applied.



If you have any questions, please don't hesitate to contact our Customer Service team or our distributors. You can find our telephone number and a list of our distributors in our online shop:

**[www.sw-motech.com](http://www.sw-motech.com)**



**Use thread locker:** Indicates that a thread must be coated with liquid thread locker. H (HIGH): high strength; M (MEDIUM): medium strength; L (LOW): low strength.



**Tighten/note the tightening torque information:**

Indicates the tightening torque of a part specified by SW-MOTECH or the vehicle manufacturer (OEM).



**Do not use thread lock:** Indicates that no liquid thread lock should be used at this point.

**PARTS LIST - READ AND KEEP MOUNTING INSTRUCTIONS!**

**4**

**1**



FBL.01.529.900.01.02

 1/1

**2**



FBL.01.529.003.03

 1/1

**3**



FBL.01.529.004.03

 1/1

**4**



M4 x 8; ISO 7380  
SC.ST.04.008.02.73800.109

 4/4

**6**

**5**



SP.ST.020.016.01.94

 1/1

**7**

**6**



FBL.00.127.003.36

 1/1

**7**



M6 x 50; DIN 912  
SC.ST.06.050.01.912.088

 1/1

**8**



M6; DIN 985  
MU.ST.06.01.985.08

 1/1

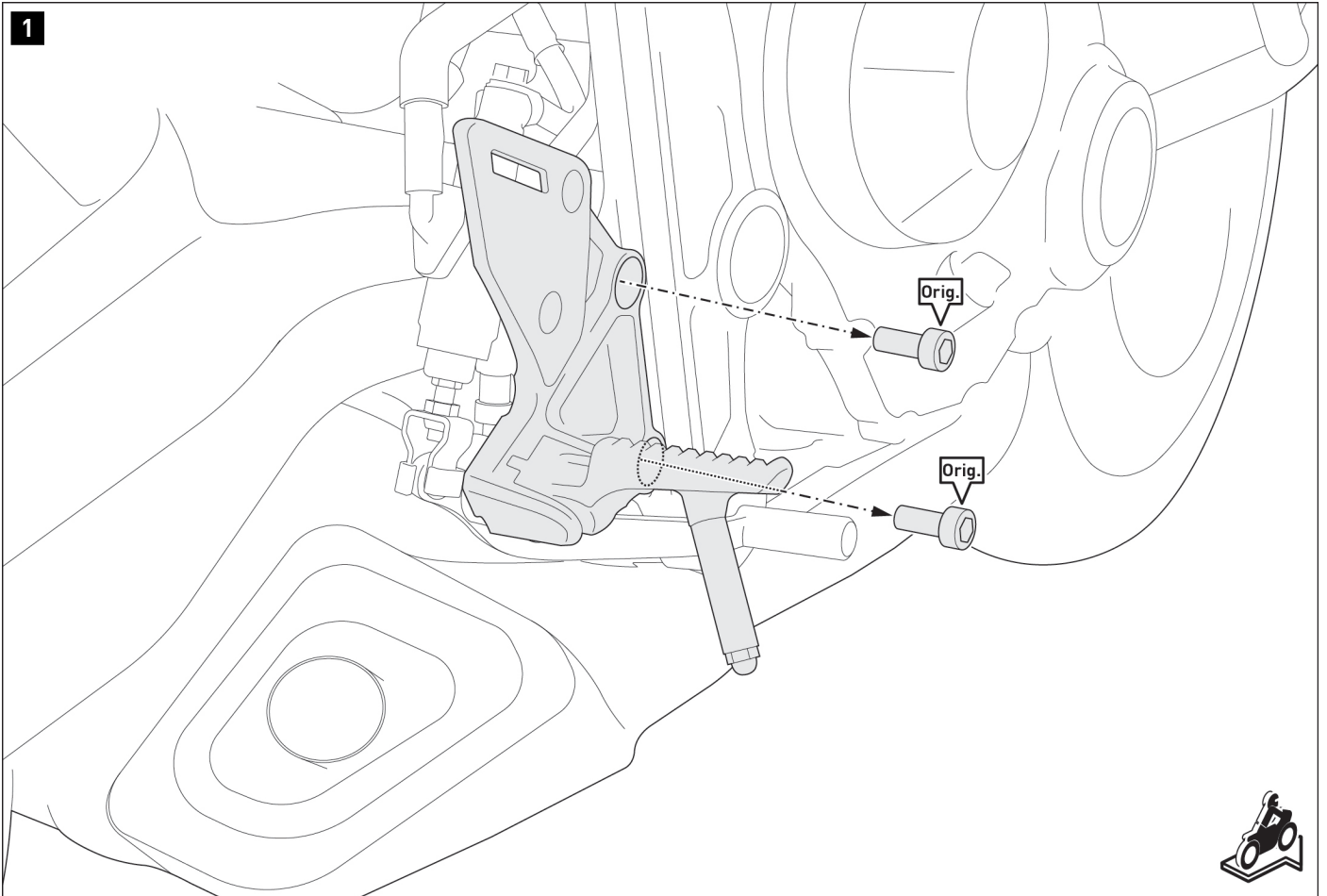

**⚠ DANGER: A brake pedal is a safety-relevant attachment!**  
For your safety, SW-MOTECH recommends that installation and/or maintenance be carried out by a qualified and certified specialist workshop!

**⚠ WARNING: Always wear eye and hand protection!**  
**⚠ WARNING: Always use suitable tools!**

**⚠ NOTE:** Before disassembling the original brake pedal, note the order and orientation of the original parts.

Remove the screws shown from the right footpeg mount.

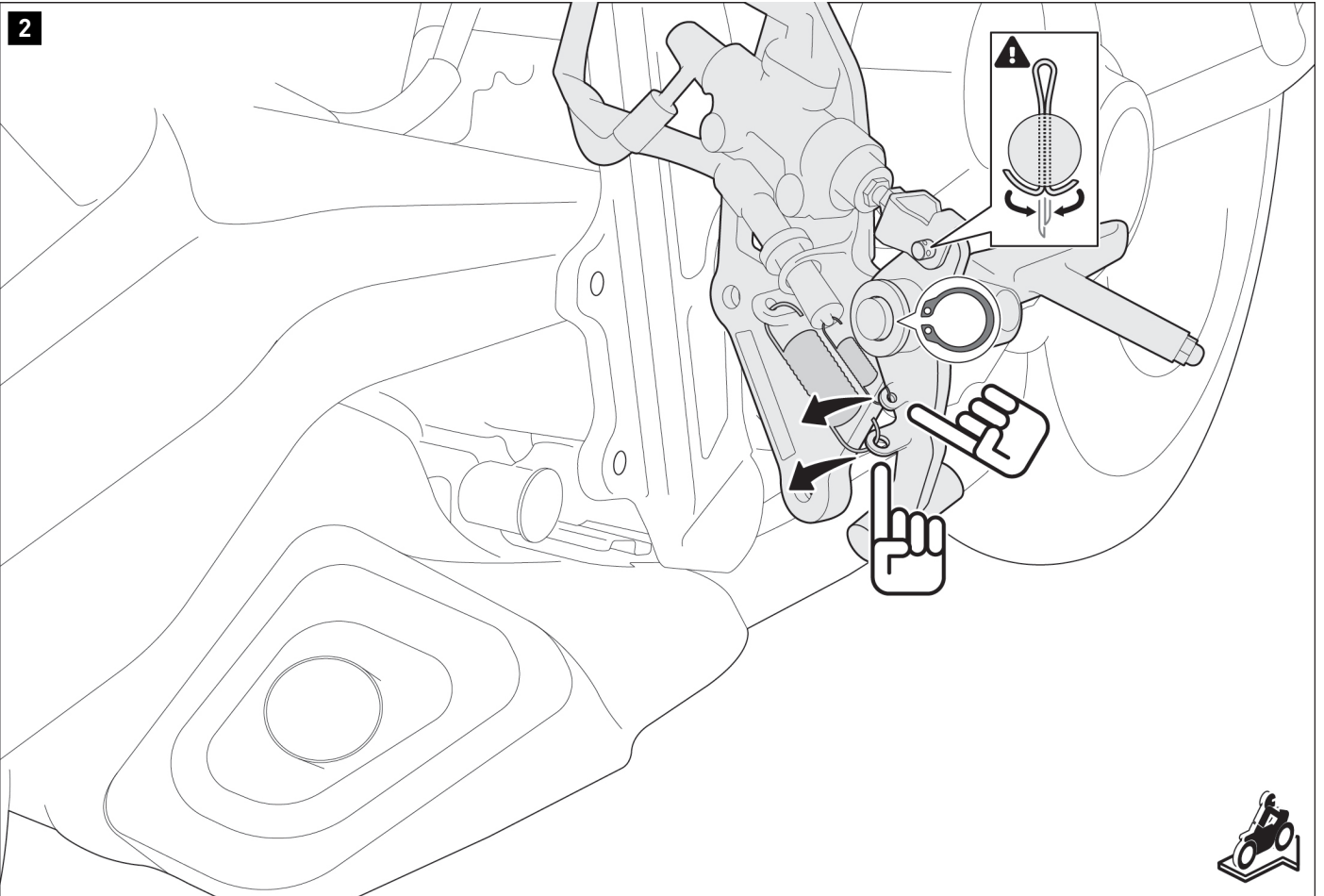

Loosen the cotter pin from the master cylinder push rod.  
Unhook the indicated springs.  
Remove the snap ring.

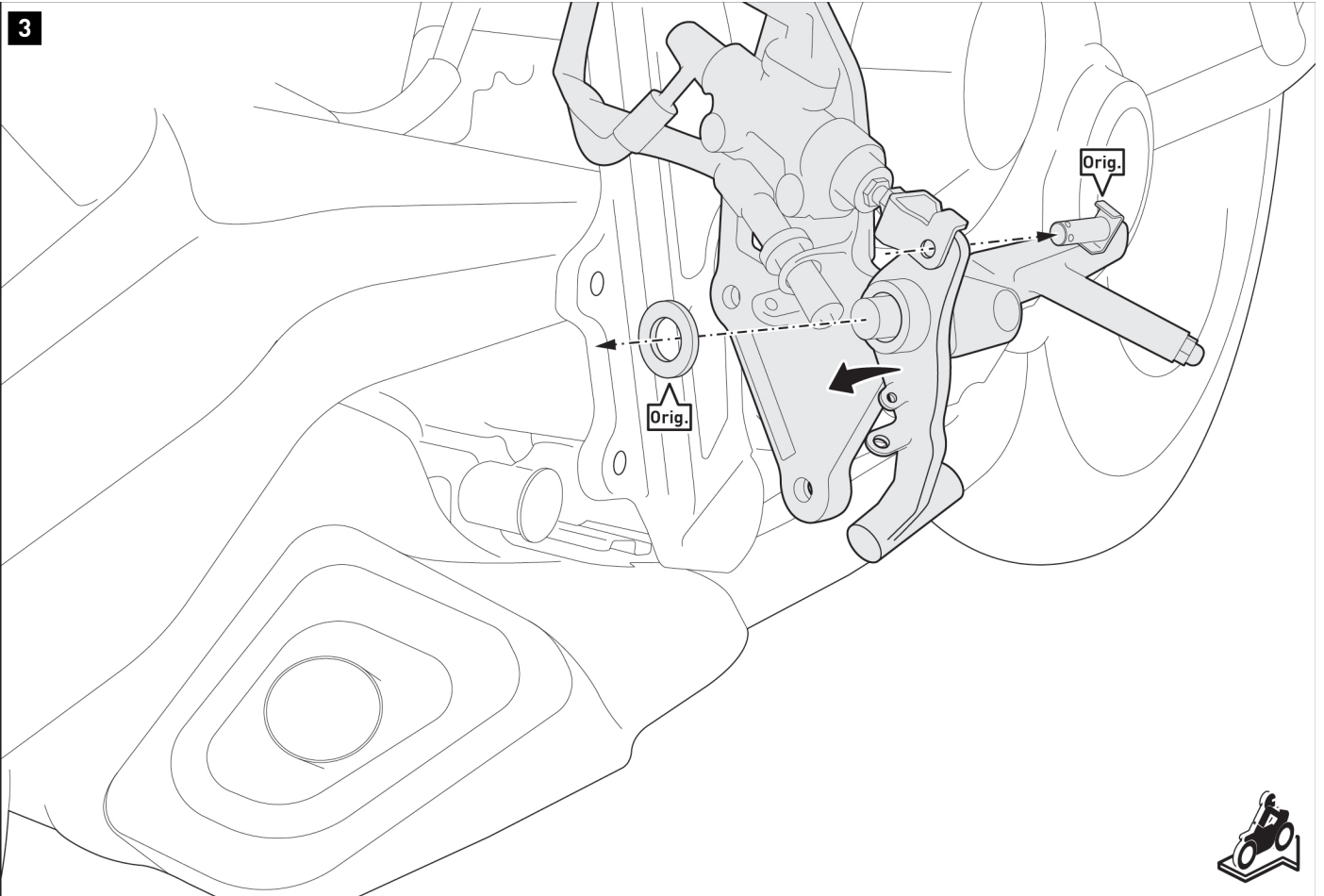

Remove the original brake pedal from the footrest mount.

4

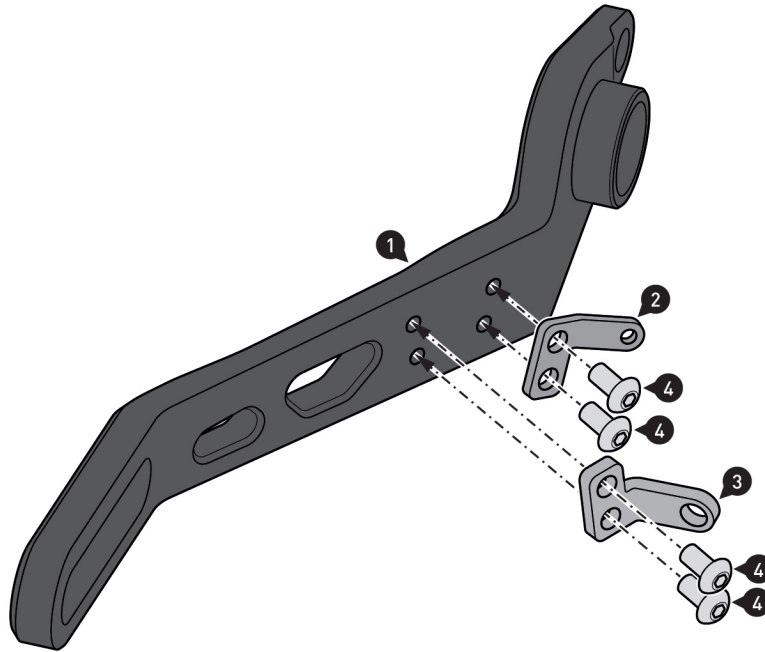

Screw the parts shown together.

**▲ WARNING: use liquid thread locker!**

Tighten the screws (4) as specified in the mounting instructions.

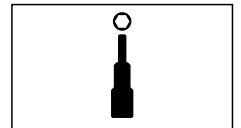
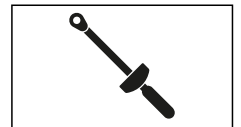
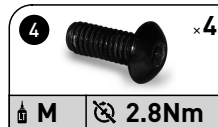

**5**

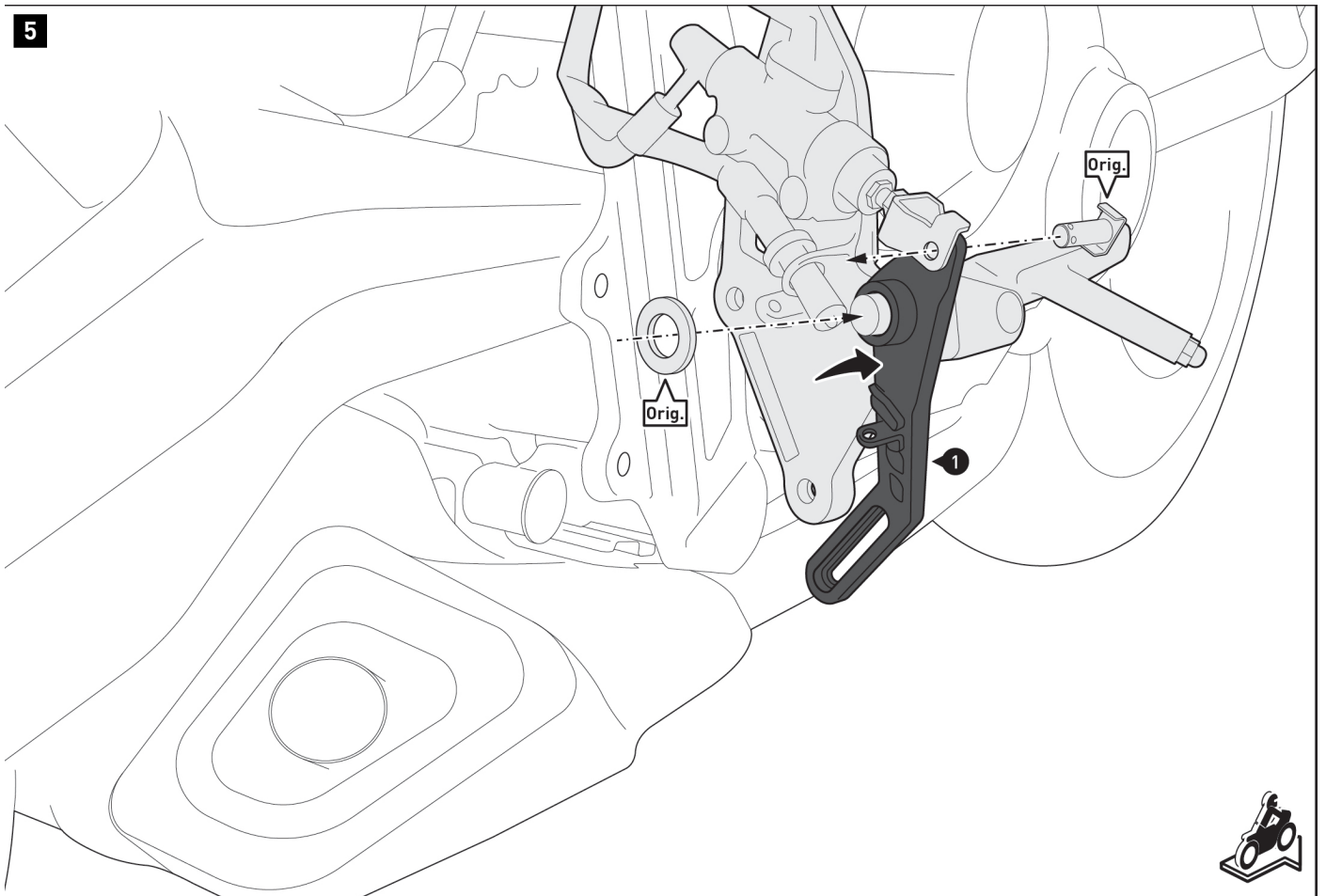

Attach the brake pedal (1) to the footrest mount using the original parts (Orig.).



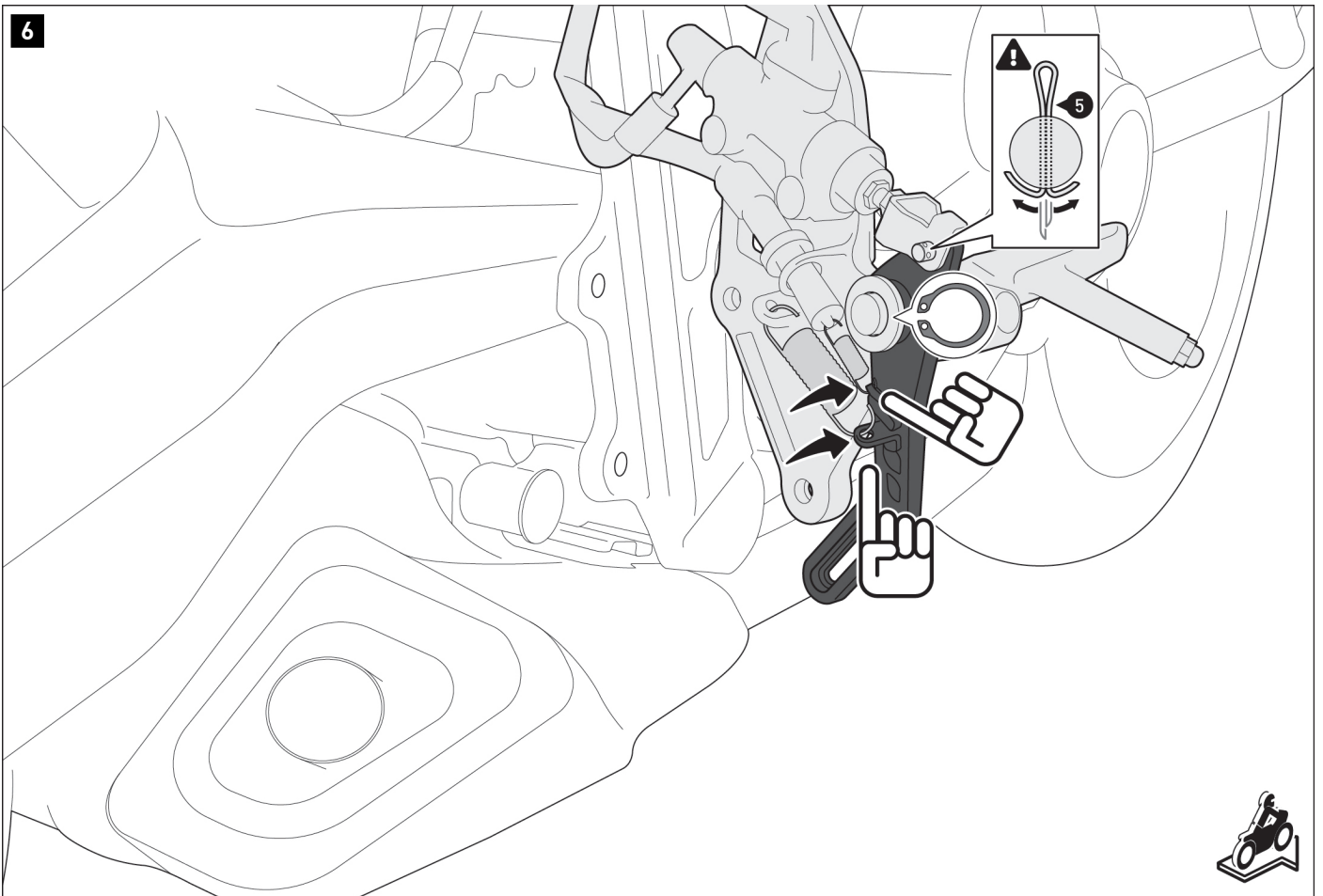

Hang the springs in the indicated position.  
Mount the original pressure rod (Orig.) using the **new** cotter pin (5).  
Attach the original snap ring.

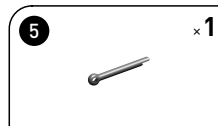

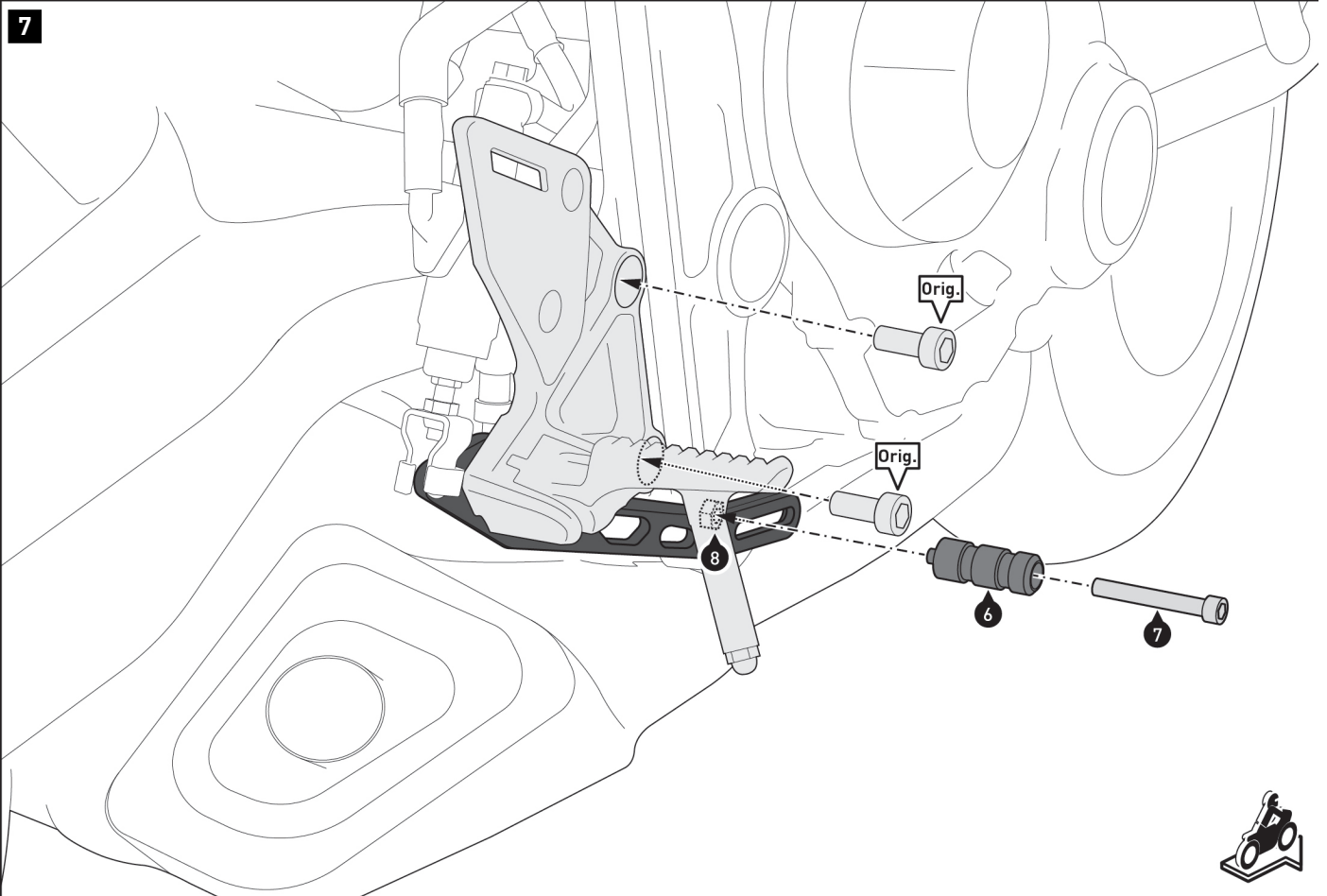

Screw the pedal (6) onto the brake pedal.  
Do not tighten the screw (7) yet.

Screw the footrest mount onto the vehicle using the original screws (Orig.).  
**▲ WARNING: Use liquid thread locker! (only for (Orig.))**  
Tighten the original (Orig.) screws according to the manufacturer's instructions.

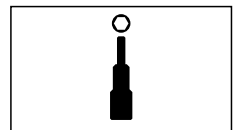
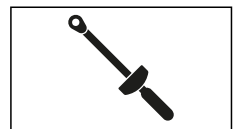
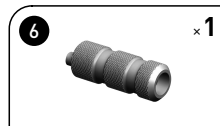

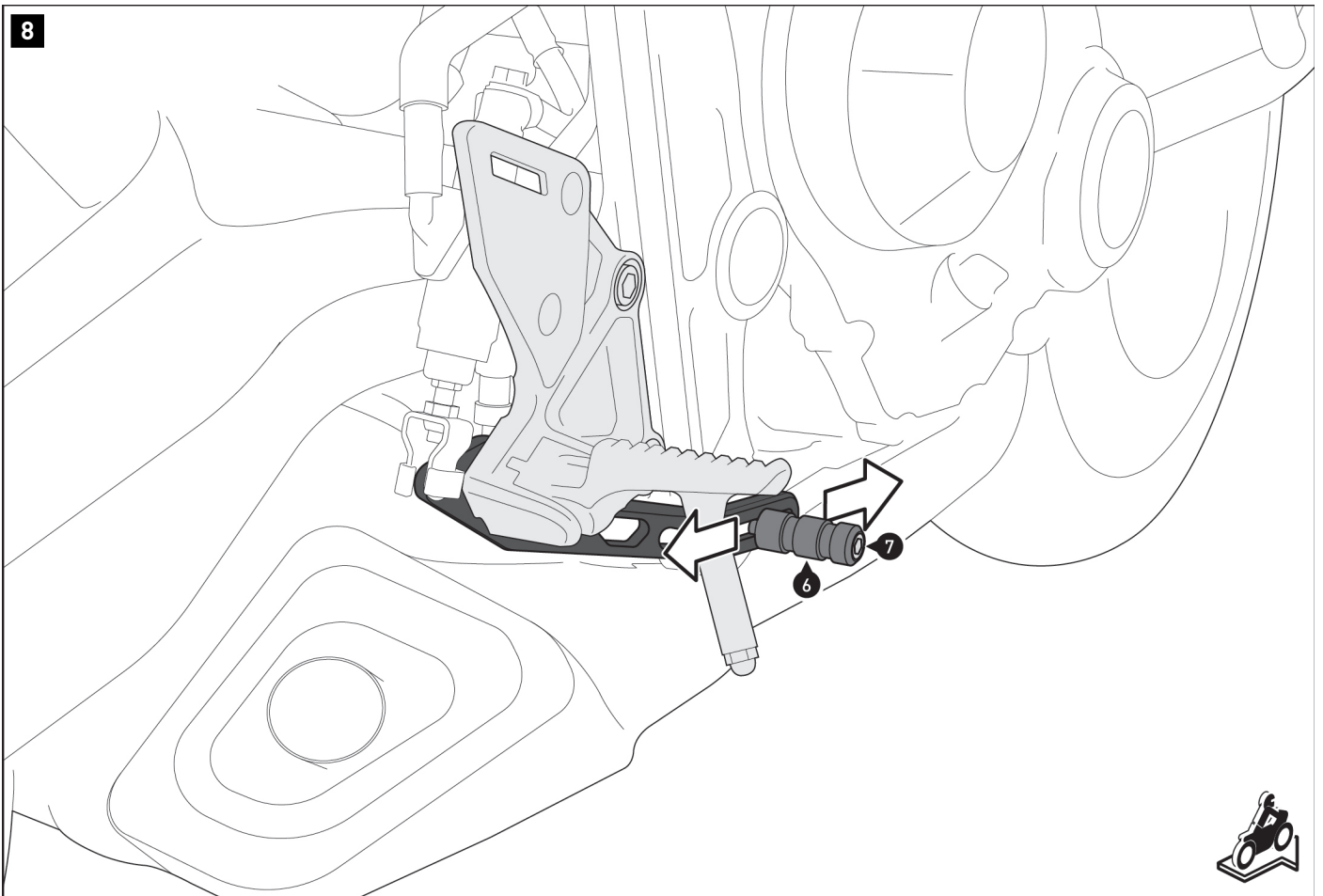

Adjust the pedal [6] according to your personal preference.  
Then tighten the screw [7] as specified in the mounting instructions.

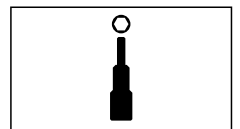
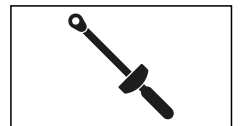

PRODUCT-SPECIFIC NOTES

**⚠ DANGER:** Finally, have a comprehensive functional check of your vehicle's brake system carried out by a qualified and certified specialist workshop!

**⚠ WARNING:** The cornering and ground clearance may be restricted by this product in the case of extreme inclination!

**⚠ NOTE:** Observe the country-specific regulations for registering/operating your vehicle or the applicable TÜV regulations. Have parts subject to registration entered in the vehicle documents by your inspection authority after installation.

**If a national type approval is available for this product:**

**You must always carry the national type approval supplied with the product with you! This national type approval only applies to the models listed and must comply with all requirements! For use with a vehicle not listed here, the entry must be made in the vehicle documents!**

The vehicle assignments in the national type approval document are expanded annually. As a result, the national type approval for a new product may only take place a few months after the market launch. If your model is not listed or if you no longer have the national type approval document, please visit the Download section of our web shop. The current version of the national type approval document will be available there.