

ANBAUANLEITUNG

mounting instructions • instructions de montage • instrucciones de montaje • istruzioni di montaggio

ADV.06.799.76005

beinhaltet • contains • contient • contiene • contiene

SBL.06.799.10002/B

SBL.06.799.10101/B

SCT.06.799.10000

MSS.06.799.10002/S

HDG.00.220.80901/B

HDG.00.220.10300/B

STP.11.176.10001/B

Item number: **SBL.06.799.10002/B**

Revision: **00** · Date: **10 - 2023**

Crash bar

 ~ 0.75 h.

EASY  DIFFICULT

ENGLISH Thank you for choosing this premium product from SW-MOTECH. Visit our online shop for more information (e.g. model assignments). Required documents (e.g. national type approval) are available there for you to download.

Please read and understand all the instructions, safety information and warnings in these mounting instructions before mounting and using the product in order to avoid injury and damage. Keep these mounting instructions for reference.

This product was developed for vehicles in factory condition. Compatibility with original accessories or accessories from other manufacturers cannot be guaranteed.

These mounting instructions have been prepared to the best of our current knowledge. No legal claims relating to accuracy can be made. Errors and omissions excepted. We reserve the right to make technical and design changes. The copyright is held by SW-MOTECH.

SAFETY WARNING SYMBOL

 This warning symbol is used in these mounting instructions to warn of deadly dangers, injuries or other hazards. The words **DANGER**, **WARNING** or **CAUTION** are used as part of this warning symbol to convey important safety messages and information relating to the installation and use of this product. These words, together with the safety warning symbol, mean:

 **DANGER:** Indicates a hazardous situation which, if not avoided, will result in death or serious injury!

 **WARNING:** Indicates a hazardous situation which, if not avoided, may result in death or serious injury!

 **CAUTION:** Indicates a hazardous situation which, if not avoided, may result in minor or moderate injury!

 **NOTE:** Important information, but not relating to a risk of death or injury (property damage only)!

GENERAL INFORMATION

 **WARNING:** Assembly and/or maintenance of this product requires advanced technical skill, appropriate tools, and a good understanding of tool usage and torque specifications. For your own safety, SW-MOTECH recommends having the assembly and/or maintenance carried out by a qualified and certified motorcycle workshop.

 **WARNING:** If you do choose to assemble this product yourself, carefully and fully read the mounting instructions before assembly and use, and follow all instructions to avoid serious injury or death. Also observe all relevant information in the vehicle manual when mounting or using the product. IF YOU DO NOT UNDERSTAND ANY PART OF THESE MOUNTING INSTRUCTIONS OR NEED AN EXPLANATION AS TO A SPECIFIC INSTRUCTION, DO NOT ATTEMPT TO INSTALL THIS PRODUCT WITHOUT CONSULTING SW-MOTECH FOR ASSISTANCE!

PREPARATION: Read the mounting instructions carefully and make sure that all parts on the parts list are available.

 **CAUTION:** Ensure that your vehicle is standing securely. Switch off the engine and remove the ignition key. Allow the engine/exhaust to cool down if necessary. Disconnect the battery when working on the electrical system. Only use proper tools and always wear safety goggles and gloves during assembly and maintenance. Have a second person help you with assembly and maintenance.

ASSEMBLY: All parts and connections removed from the vehicle must be reinstalled according to the vehicle manufacturer's specifications or replaced with parts and hardware supplied by SW-MOTECH.

 **WARNING:** Secure all threads with a medium-strength liquid threadlocker, unless otherwise specified.

 **DANGER:** Tightening torques not defined by SW-MOTECH must be obtained from the vehicle manufacturer or a certified motorbike workshop.

FUNCTIONAL CHECK: After mounting the product, ensure that no moving parts are obstructed and that the function of the vehicle is not impeded. Cables and hoses must not rub against each other and/or be hindered in any way.

 **WARNING:** Carry out a comprehensive functionality check before you start to drive. Check the tightening torque of all connections and the tight fit of the product after the first 50 km and then at regular intervals. Mounted accessories can change the handling and stability of the vehicle.



SW-MOTECH GmbH & Co. KG
Ernteweg 7-10
35282 Rauschenberg
Germany



info@sw-motech.com
www.sw-motech.com



Take note of the symbols and what they mean in the ASSEMBLY section. If the term OEM appears in the ASSEMBLY section, the vehicle manufacturer's specifications must be observed and applied.



If you have any questions, please don't hesitate to contact our Customer Service team or our distributors. You can find our telephone number and a list of our distributors in our online shop:

www.sw-motech.com

















































Use thread locker: Indicates that a thread must be coated with liquid thread locker. H (HIGH): high strength; M (MEDIUM): medium strength; L (LOW): low strength.



Tighten/note the tightening torque information:

Indicates the tightening torque of a part specified by SW-MOTECH or the vehicle manufacturer (OEM).

PARTS LIST - READ AND KEEP MOUNTING INSTRUCTIONS!

<p>2</p>	<p>1</p>  <p>SBL.00.051.011.11</p> <p> 1/2</p>	<p>2</p>  <p>SBL.00.051.010.11</p> <p> 1/2</p>	<p>3</p>  <p>M6 x 25; DIN 912 SC.ST.06.025.01.912.088</p> <p> 1/2</p>	<p>4</p>  <p>SST.0880.0200.0020.02</p> <p> 2/2</p>		
<p>3</p>	<p>5</p>  <p>SBL.06.799.902.01.11</p> <p> 1/1</p>	<p>6</p>  <p>M10 x 60; DIN 912 SC.ST.10.060.01.912F.088</p> <p> 1/1</p>	<p>7</p>  <p>ø 10,5; DIN 125 US.ST.105.01.125</p> <p> 1/2</p>	<p>8</p>  <p>Ø 25 / ø 12,5 / h 15 DB.00.250.125.015.01</p> <p> 1/1</p>	<p>8</p>  <p>Ø 25 / ø 10,5 / h 17 DB.00.250.105.017.01</p> <p> 1/1</p>	<p>9</p>  <p>M12 x 75; DIN 912 SC.ST.12.075.01.912F.088</p> <p> 1/1</p>
<p>10</p>  <p>ø 13; DIN 125 US.ST.130.01.125</p> <p> 1/2</p>						
<p>5</p>	<p>12</p>  <p>SBL.00.051.011.11</p> <p> 1/2</p>	<p>13</p>  <p>SBL.00.051.010.11</p> <p> 1/2</p>	<p>14</p>  <p>M6 x 25; DIN 912 SC.ST.06.025.01.912.088</p> <p> 1/2</p>			
<p>6</p>	<p>15</p>  <p>SBL.06.799.009.11</p> <p> 2/2</p>	<p>16</p>  <p>M8 x 16; DIN 912 SC.ST.08.016.01.912.088</p> <p> 2/2</p>	<p>17</p>  <p>ø 8,4; DIN 125 US.ST.084.01.125</p> <p> 2/4</p>			
<p>7</p>	<p>18</p>  <p>SBL.06.799.901.01.11</p> <p> 1/1</p>	<p>19</p>  <p>M12 x 65; DIN 912 SC.ST.12.065.01.912F.088</p> <p> 1/1</p>	<p>20</p>  <p>ø 13; DIN 125 US.ST.130.01.125</p> <p> 1/2</p>	<p>21</p>  <p>Ø 25 / ø 12,5 / h 25 DB.00.250.125.025.01</p> <p> 1/1</p>	<p>22</p>  <p>M10 x 65; DIN 912 SC.ST.10.065.01.912F.088</p> <p> 1/1</p>	<p>23</p>  <p>ø 10,5; DIN 125 US.ST.105.01.125</p> <p> 1/2</p>

PARTS LIST - READ AND KEEP MOUNTING INSTRUCTIONS!

24



Ø 25 / ø 10,5 / h 28
DB.00.250.105.028.01

 **1/1**

8

25



M8 x 20; DIN 912
SC.ST.08.020.01.912.088

 **2/2**

26



Ø 8,4; DIN 125
US.ST.084.01.125

 **2/4**

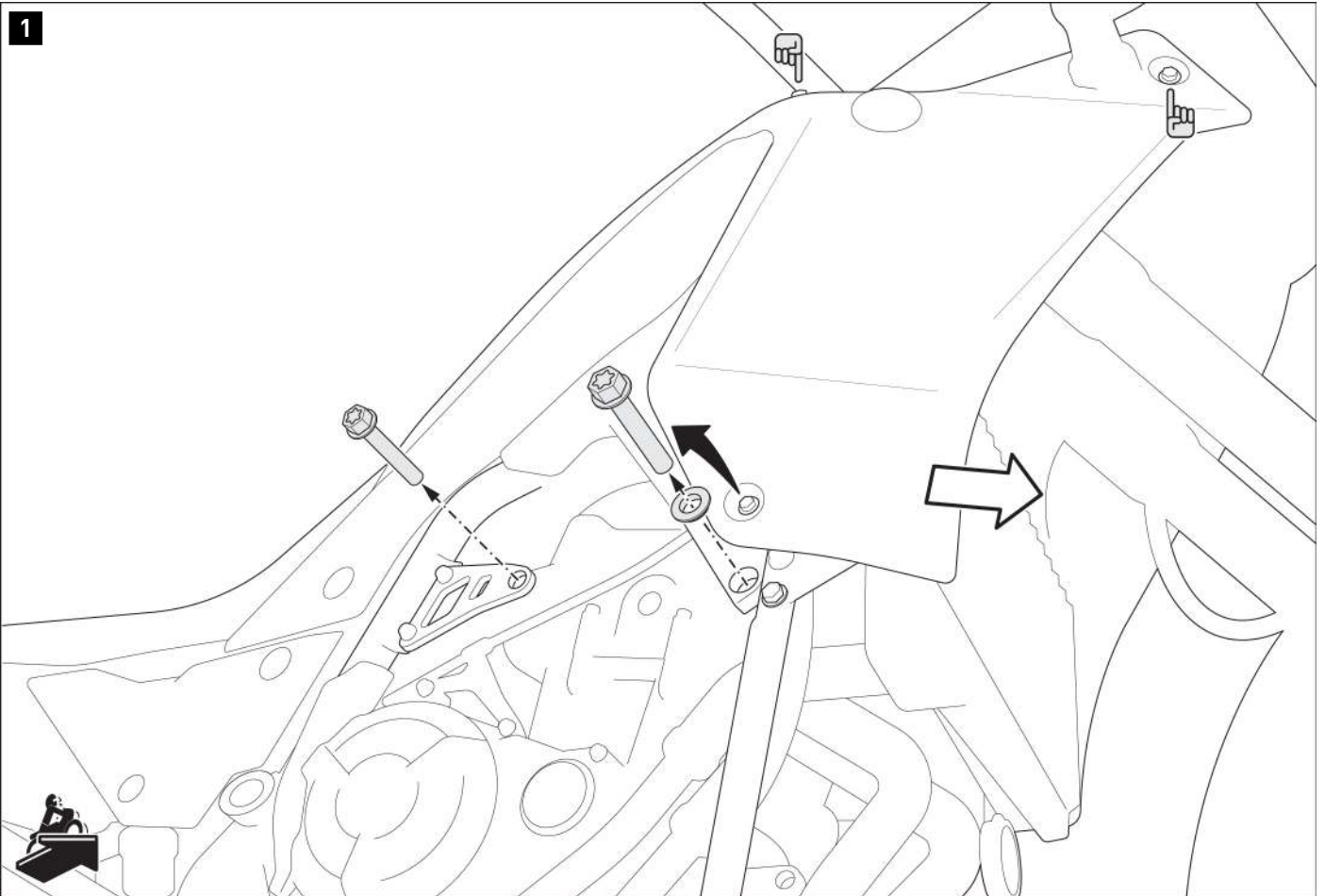

▲ WARNING: Always wear eye and hand protection!
▲ WARNING: Always use the proper tools!

▲ WARNING: Do not start fitting the left crash bar until you have finished fitting the right-hand crash bar!

Remove the bottom screw of the right side panel; then loosen the top two screws.
Push the side panel forward slightly.

Remove the two screws indicated on the right side of the vehicle.

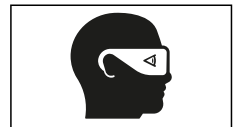

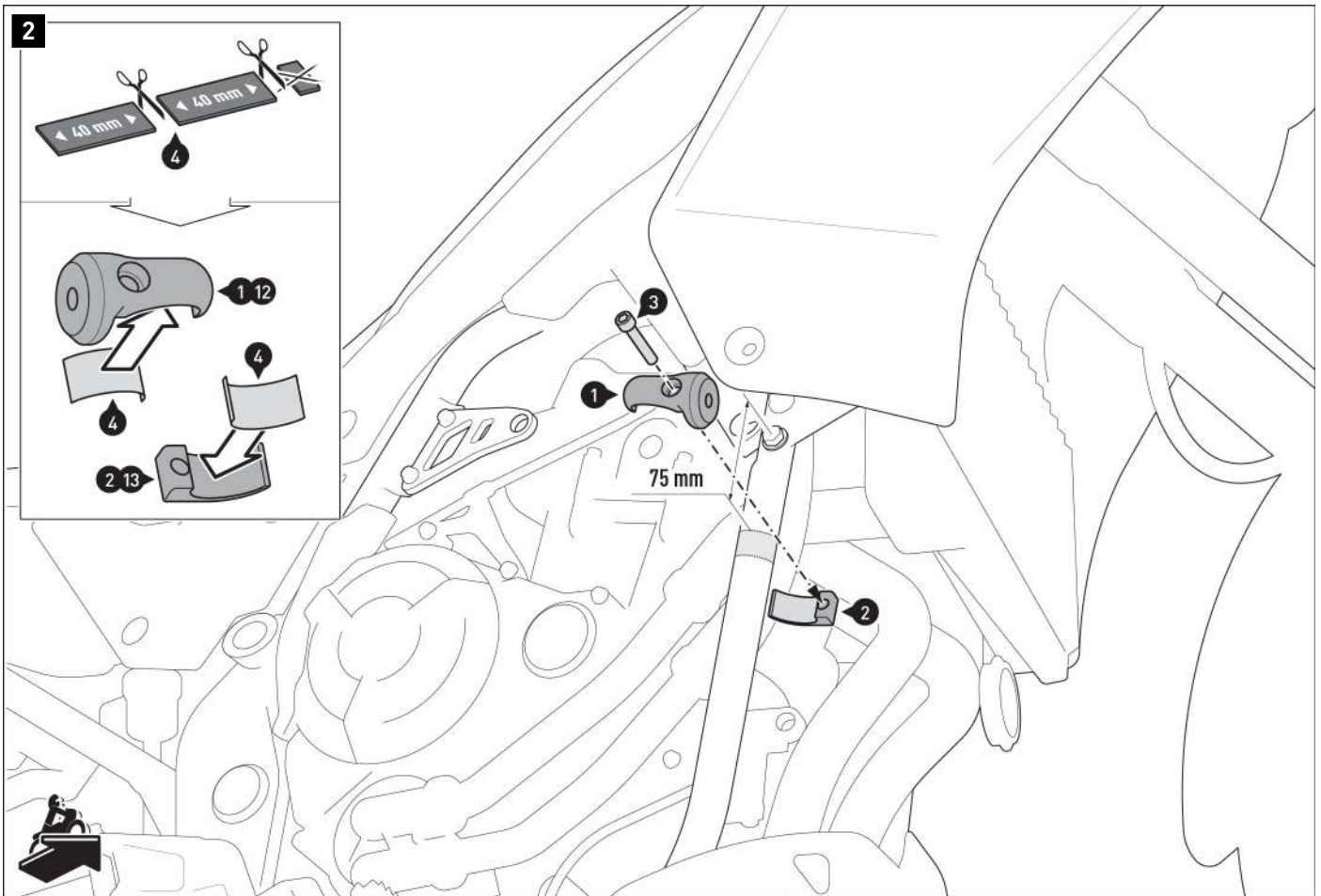

Cut each of the rubber strips (4) into two 40 mm pieces (the rest is no longer required). Then glue the rubber strips (4) into the clamps (1), (2), (12) and (13) as shown in the detailed drawing.

Screw the clamps (1) and (2) to the vehicle frame. To determine the height, use the indicated measurement of 75 mm (from the middle of the screw head to the top edge of the clamp (1)).

▲ WARNING: Use liquid thread locker!

Tighten the screw (3) as specified in the mounting instructions.

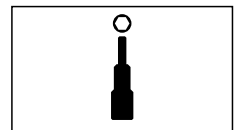
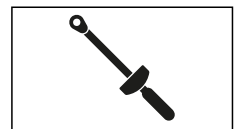

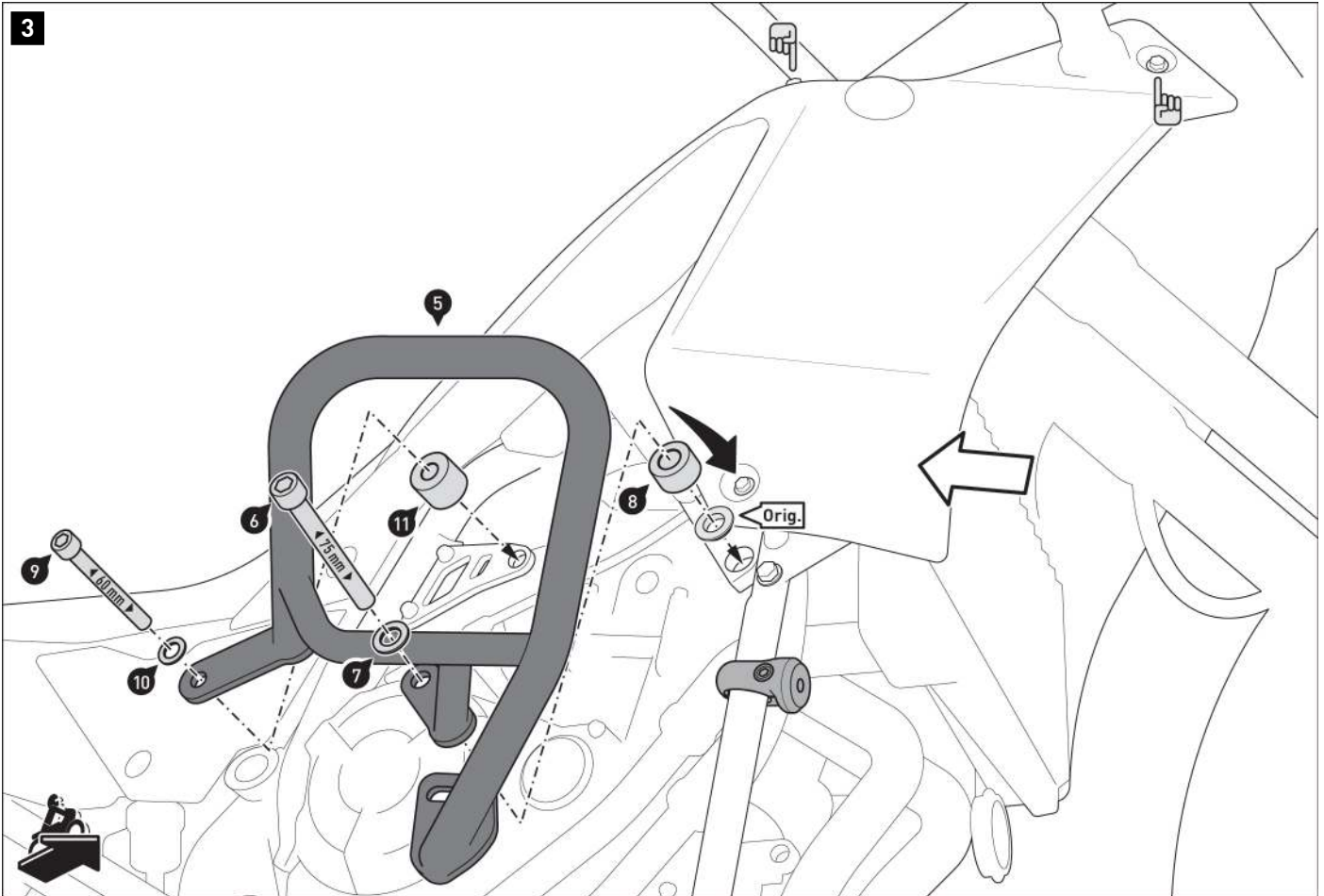

Screw the right crash bar [5] to the original socket [Orig.] on the vehicle.

▲ WARNING: Use a liquid threadlocker!
Do not tighten screws [6] and [9] yet.

Screw the side panel loosened in step [1] back onto the vehicle.

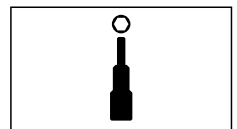

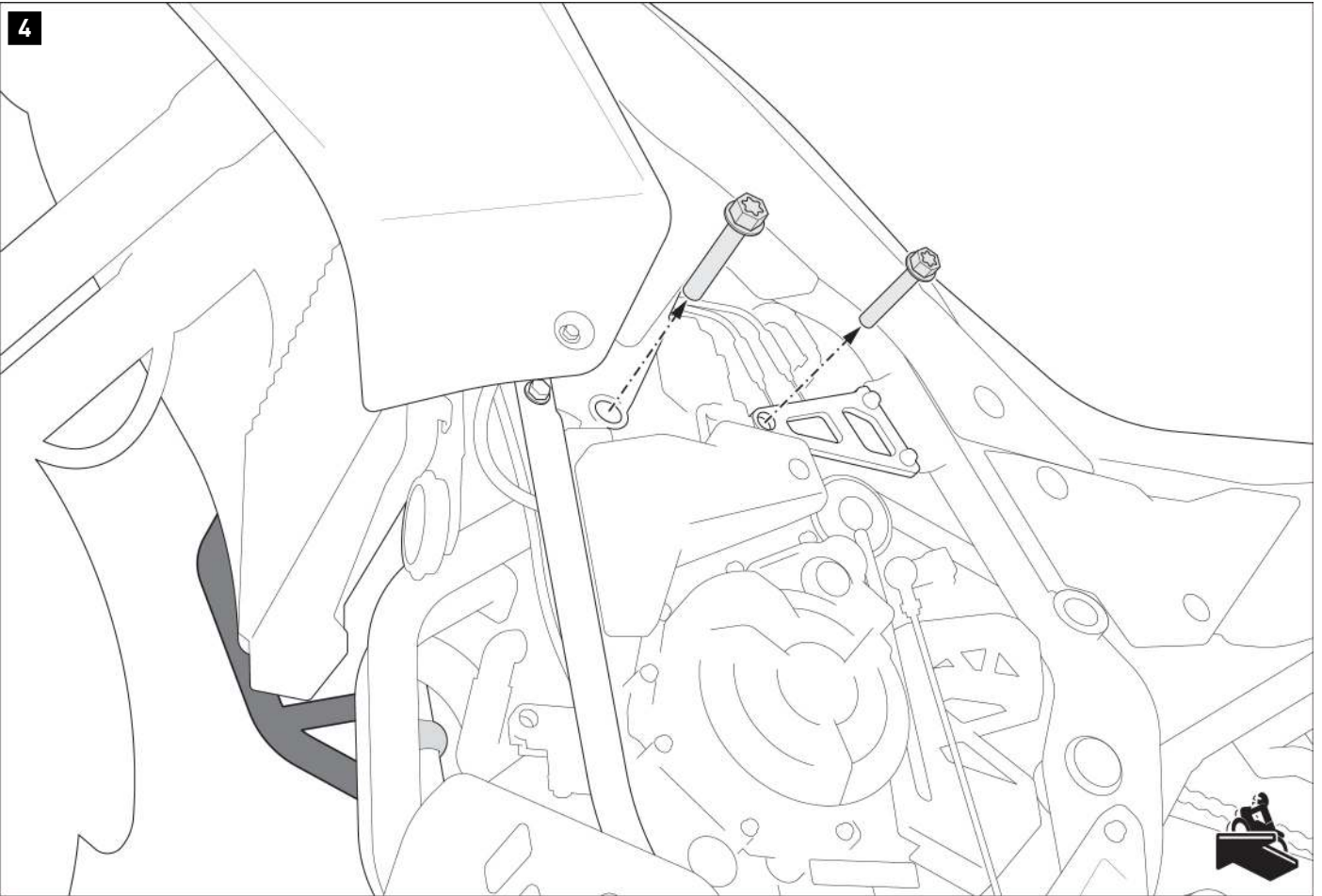

Remove the two screws indicated on the left side of the vehicle.

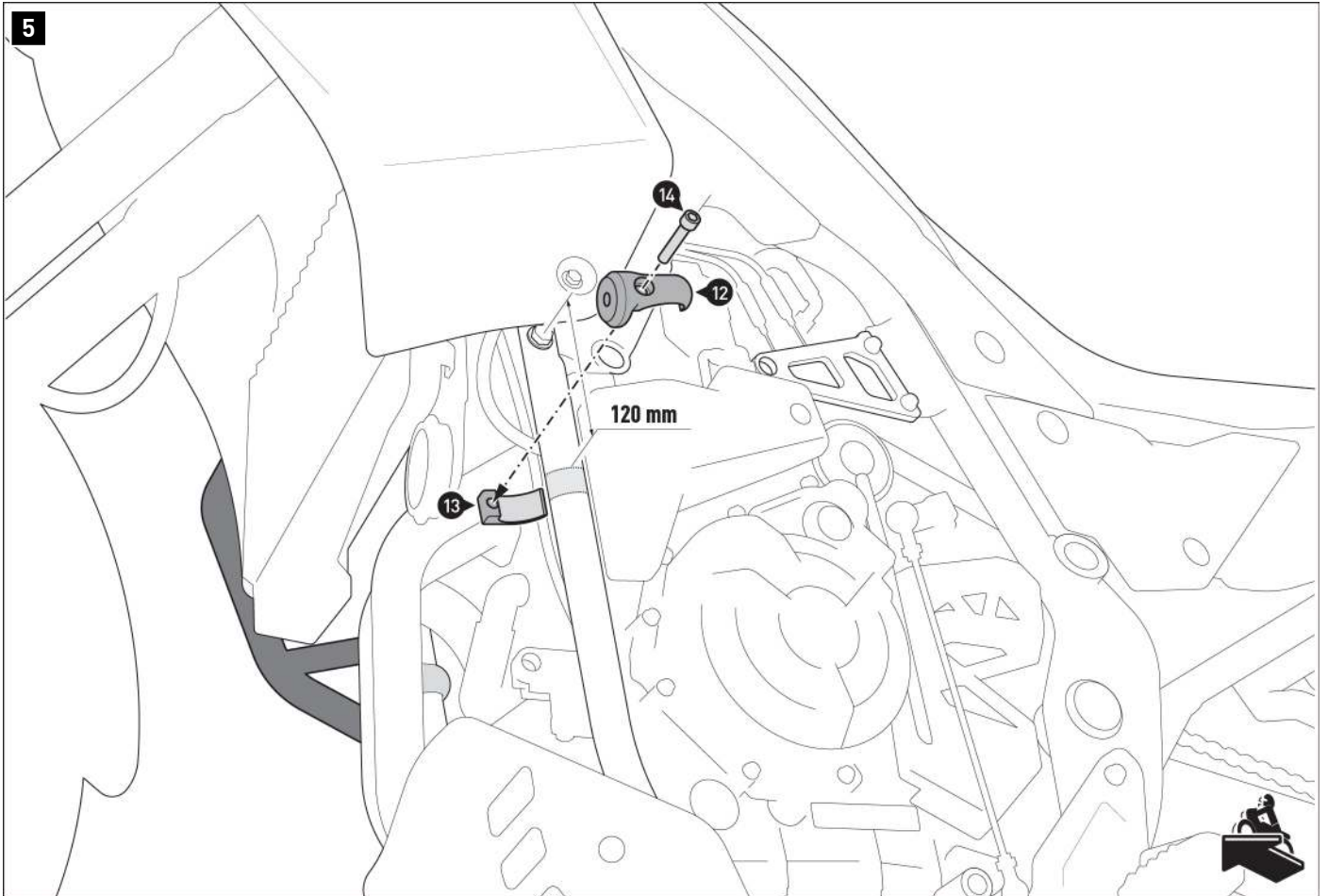

Screw the clamps (12) and (13) to the vehicle frame.
 To determine the height, use the indicated measurement of 120 mm (from the middle of the screw head to the top edge of the clamp (12)).
▲ WARNING: Use a liquid threadlocker!
 Tighten the screw (14) as specified in the mounting instructions.

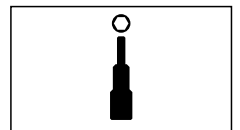
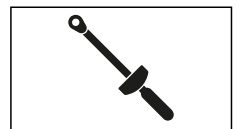

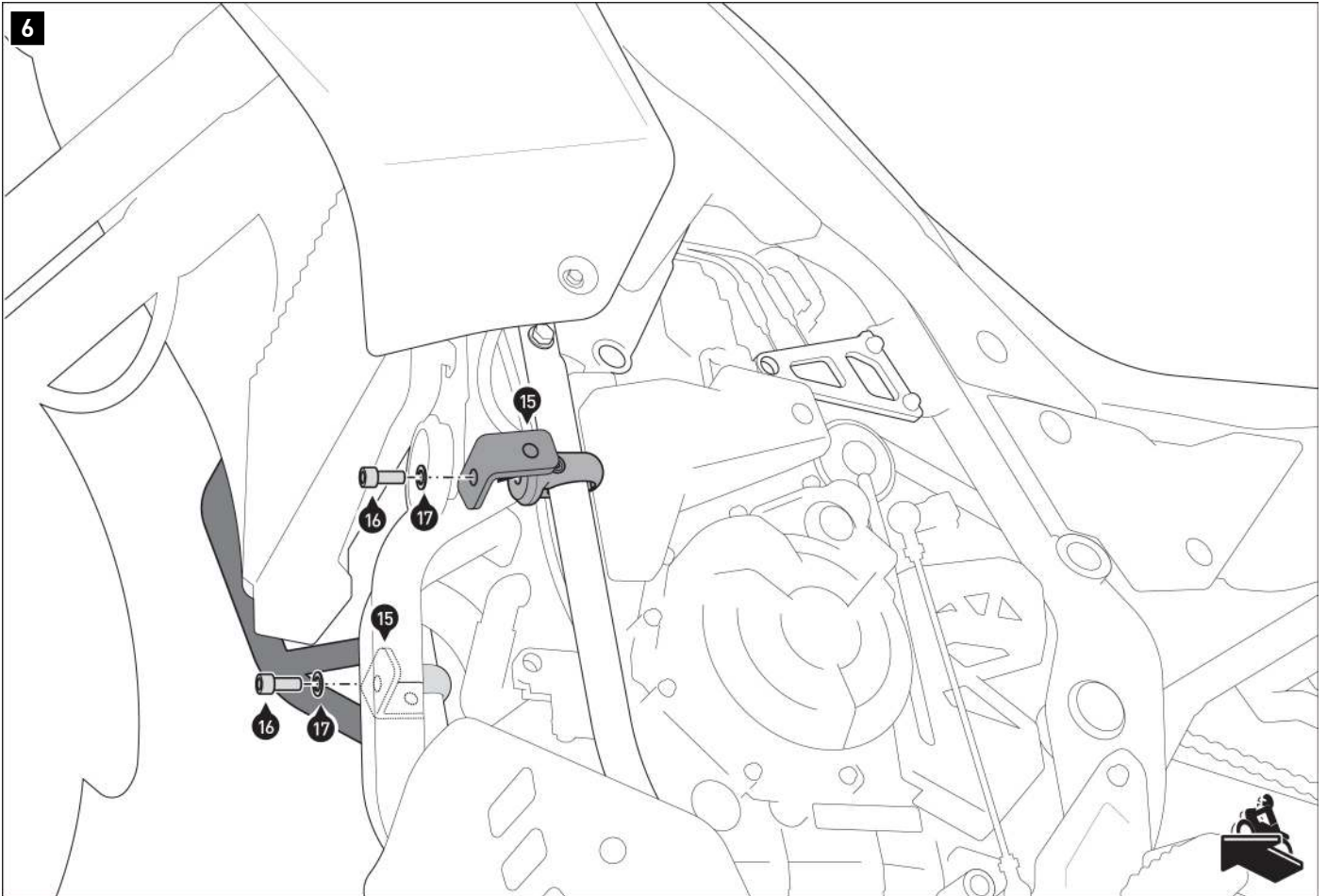

Screw the mounting brackets [15] onto clamps (1) and (12).
▲ WARNING: Use a liquid threadlocker!
 Do not tighten the screws (16) yet.



M 18 Nm

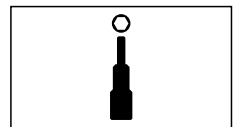
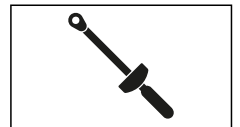

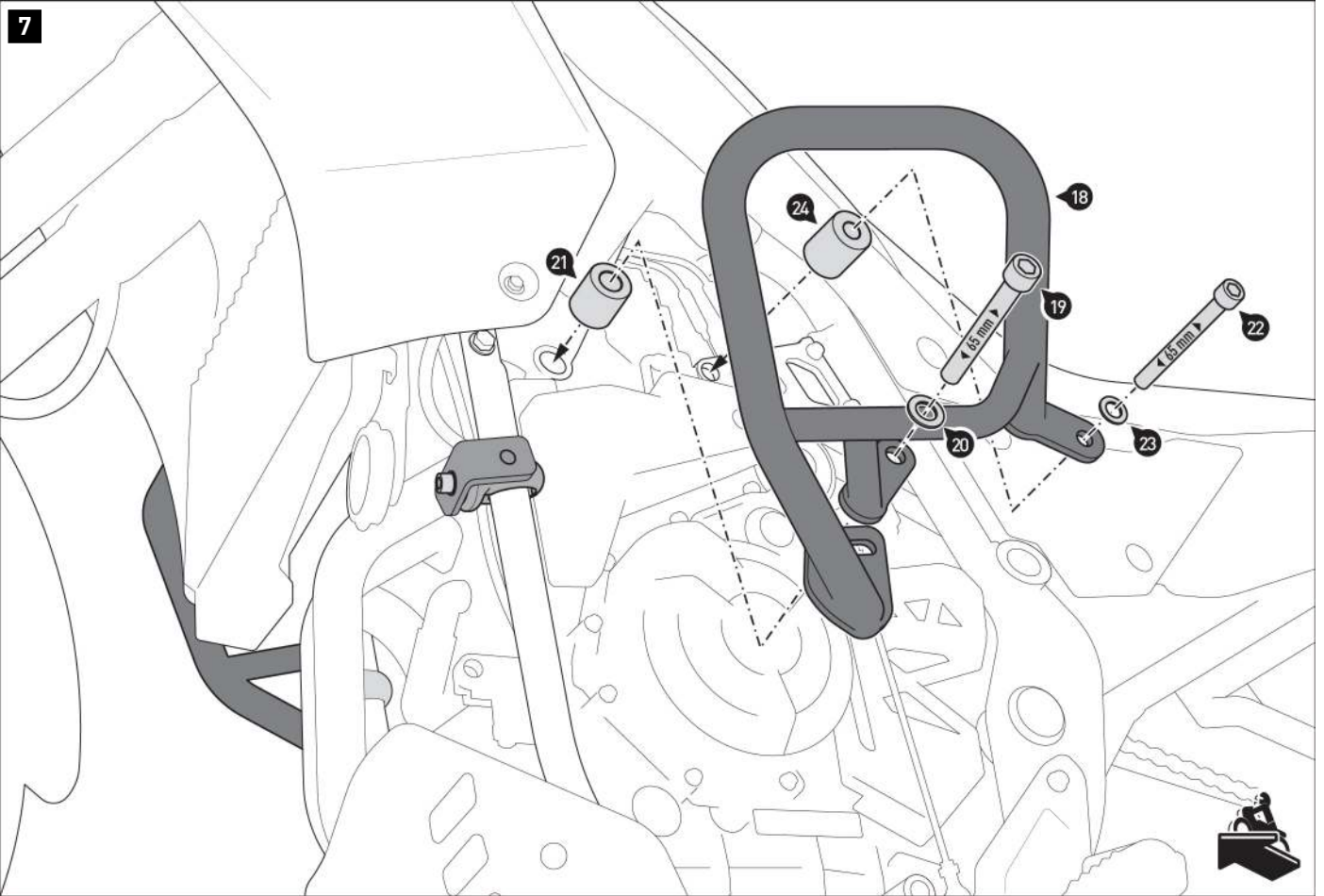

Screw the left crash bar [18] on to the vehicle.
▲ WARNING: Use a liquid threadlocker!
 Do not tighten screws [19] and [22] yet.

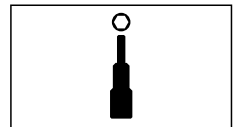

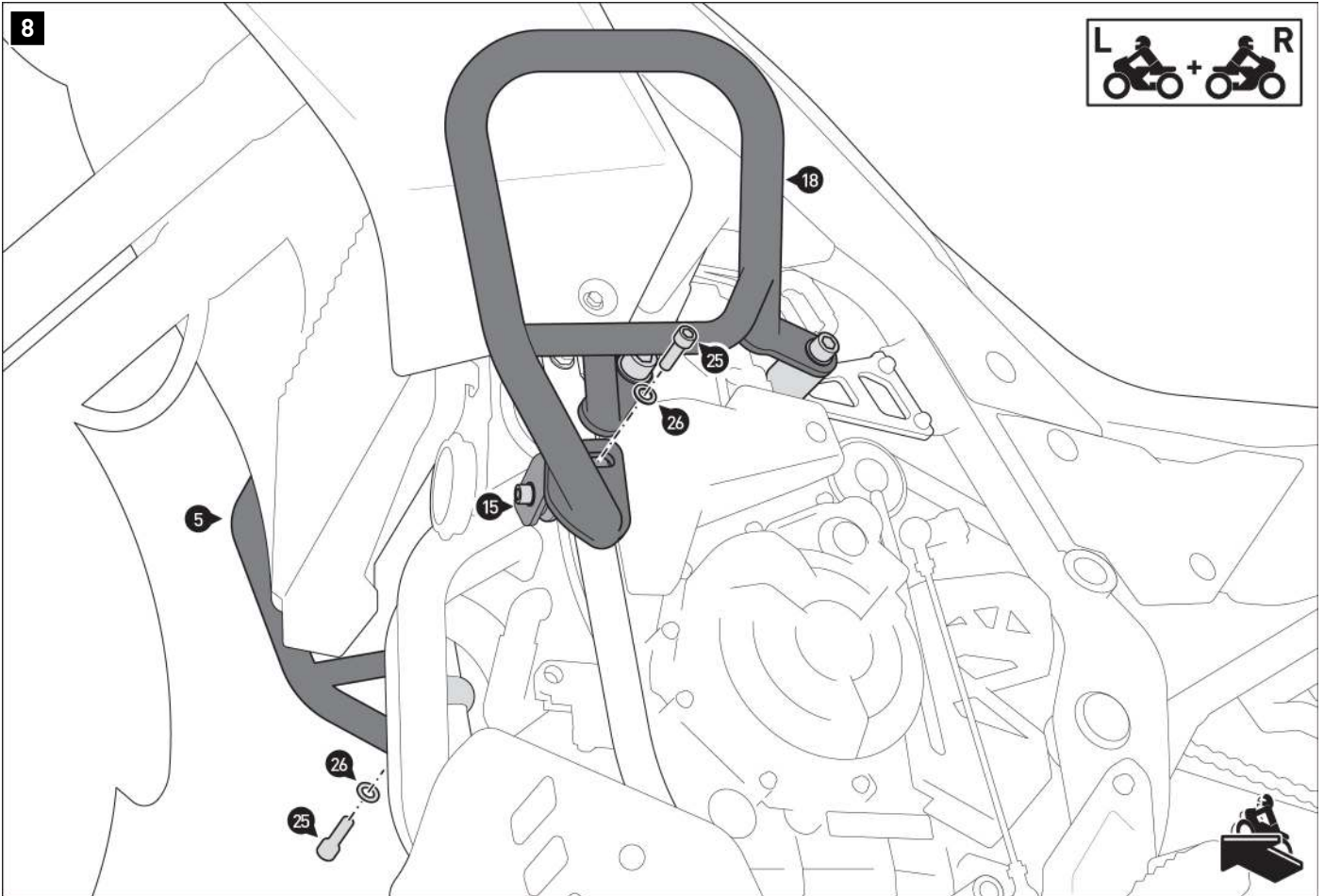

Screw the crash bars (5) and (18) to the mounting brackets (15).

▲ WARNING: Use a liquid threadlocker!

When all components have been loosely attached, tighten the screws (16) and (25) as specified in the mounting instructions.

Tighten screws (6), (9), (19) and (22) according to the manufacturer's instructions.



M 20 Nm

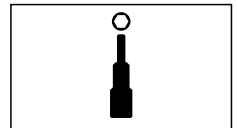
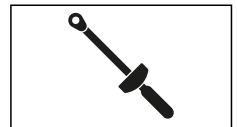

PRODUCT-SPECIFIC NOTES

⚠ WARNING: This product may inhibit cornering and ground clearance in cases of extreme inclination!

⚠ NOTE: Please observe the country-specific regulations for the registration/operation of your vehicle or any applicable TÜV regulations. After installation, parts subject to registration should be entered in the vehicle documents by your test center.

Item number: **SBL.06.799.10101/B**

Revision: **00** · Date: **11 - 2023**

Upper crash bar

 ~ 1 h.

EASY     DIFFICULT

ENGLISH Thank you for choosing this premium product from SW-MOTECH. Visit our online shop for more information (e.g. model assignments). Required documents (e.g. national type approval) are available there for you to download.

Please read and understand all the instructions, safety information and warnings in these mounting instructions before mounting and using the product in order to avoid injury and damage. Keep these mounting instructions for reference.

This product was developed for vehicles in factory condition. Compatibility with original accessories or accessories from other manufacturers cannot be guaranteed.

These mounting instructions have been prepared to the best of our current knowledge. No legal claims relating to accuracy can be made. Errors and omissions excepted. We reserve the right to make technical and design changes. The copyright is held by SW-MOTECH.

SAFETY WARNING SYMBOL

 This warning symbol is used in these mounting instructions to warn of deadly dangers, injuries or other hazards. The words **DANGER**, **WARNING** or **CAUTION** are used as part of this warning symbol to convey important safety messages and information relating to the installation and use of this product. These words, together with the safety warning symbol, mean:

 **DANGER:** Indicates a hazardous situation which, if not avoided, will result in death or serious injury!

 **WARNING:** Indicates a hazardous situation which, if not avoided, may result in death or serious injury!

 **CAUTION:** Indicates a hazardous situation which, if not avoided, may result in minor or moderate injury!

 **NOTE:** Important information, but not relating to a risk of death or injury (property damage only)!

GENERAL INFORMATION

 **WARNING:** Assembly and/or maintenance of this product requires advanced technical skill, appropriate tools, and a good understanding of tool usage and torque specifications. For your own safety, SW-MOTECH recommends having the assembly and/or maintenance carried out by a qualified and certified motorcycle workshop.

 **WARNING:** If you do choose to assemble this product yourself, carefully and fully read the mounting instructions before assembly and use, and follow all instructions to avoid serious injury or death. Also observe all relevant information in the vehicle manual when mounting or using the product. IF YOU DO NOT UNDERSTAND ANY PART OF THESE MOUNTING INSTRUCTIONS OR NEED AN EXPLANATION AS TO A SPECIFIC INSTRUCTION, DO NOT ATTEMPT TO INSTALL THIS PRODUCT WITHOUT CONSULTING SW-MOTECH FOR ASSISTANCE!

PREPARATION: Read the mounting instructions carefully and make sure that all parts on the parts list are available.

 **CAUTION:** Ensure that your vehicle is standing securely. Switch off the engine and remove the ignition key. Allow the engine/exhaust to cool down if necessary. Disconnect the battery when working on the electrical system. Only use proper tools and always wear safety goggles and gloves during assembly and maintenance. Have a second person help you with assembly and maintenance.

ASSEMBLY: All parts and connections removed from the vehicle must be reinstalled according to the vehicle manufacturer's specifications or replaced with parts and hardware supplied by SW-MOTECH.

 **WARNING:** Secure all threads with a medium-strength liquid threadlocker, unless otherwise specified.

 **DANGER:** Tightening torques not defined by SW-MOTECH must be obtained from the vehicle manufacturer or a certified motorbike workshop.

FUNCTIONAL CHECK: After mounting the product, ensure that no moving parts are obstructed and that the function of the vehicle is not impeded. Cables and hoses must not rub against each other and/or be hindered in any way.

 **WARNING:** Carry out a comprehensive functionality check before you start to drive. Check the tightening torque of all connections and the tight fit of the product after the first 50 km and then at regular intervals. Mounted accessories can change the handling and stability of the vehicle.



SW-MOTECH GmbH & Co. KG
Ernteweg 7-10
35282 Rauschenberg
Germany



info@sw-motech.com
www.sw-motech.com



Take note of the symbols and what they mean in the ASSEMBLY section. If the term OEM appears in the ASSEMBLY section, the vehicle manufacturer's specifications must be observed and applied.



If you have any questions, please don't hesitate to contact our Customer Service team or our distributors. You can find our telephone number and a list of our distributors in our online shop:

www.sw-motech.com



Do not use thread lock: Indicates that no liquid thread lock should be used at this point.



Tighten/note the tightening torque information:

Indicates the tightening torque of a part specified by SW-MOTECH or the vehicle manufacturer (OEM).



Use thread locker: Indicates that a thread must be coated with liquid thread locker. H (HIGH): high strength; M (MEDIUM): medium strength; L (LOW): low strength.

PARTS LIST - READ AND KEEP MOUNTING INSTRUCTIONS!

3

1



NSW.06.799.002L.11

 1/1

2



NSW.06.799.002R.11

 1/1

3



M8 x 60; ISO 7380
SC.ST.08.060.02.7380.109

 2/2

4



M8; DIN 6927
MU.ST.08.02.6927.08

 2/2

4

5



SBL.00.051.011.11

 2/2

6



SBL.00.051.010.11

 2/4

7



40 mm
SST.0400.0220.0010.02

 8/8

8



M6 x 30; DIN 912
SC.ST.06.030.02.912.088

 2/4

9



SBL.06.799.903.01.11

 1/1

10



SBL.06.799.904.01.11

 1/1

5

11



KES.RD.210.0300.02.GL

 2/2

12



SBL.06.799.008.11

 1/1

13



M8 x 25; ISO 7380
SC.ST.08.025.02.7380.109

 2/2

14



M8 x 16; ISO 7380
SC.ST.08.016.02.73800.109

 2/2

15



ø 8,4; DIN 125
US.ST.084.02.125

 2/2

16



SBL.00.051.010.11

 2/4

17



M6 x 30; DIN 912
SC.ST.06.030.02.912.088

 2/4

7

18



M6 x 30; DIN 912
SC.ST.06.030.01.912.088

 4/4

19



ø 6,4; DIN 9021
US.ST.064.01.9021

 2/2

20



ø 6,4; DIN 125
US.ST.064.01.125

 2/2

21



Ø 14 / ø 6,2 / h 11
DB.ST.0140.0062.0110.02

 4/4

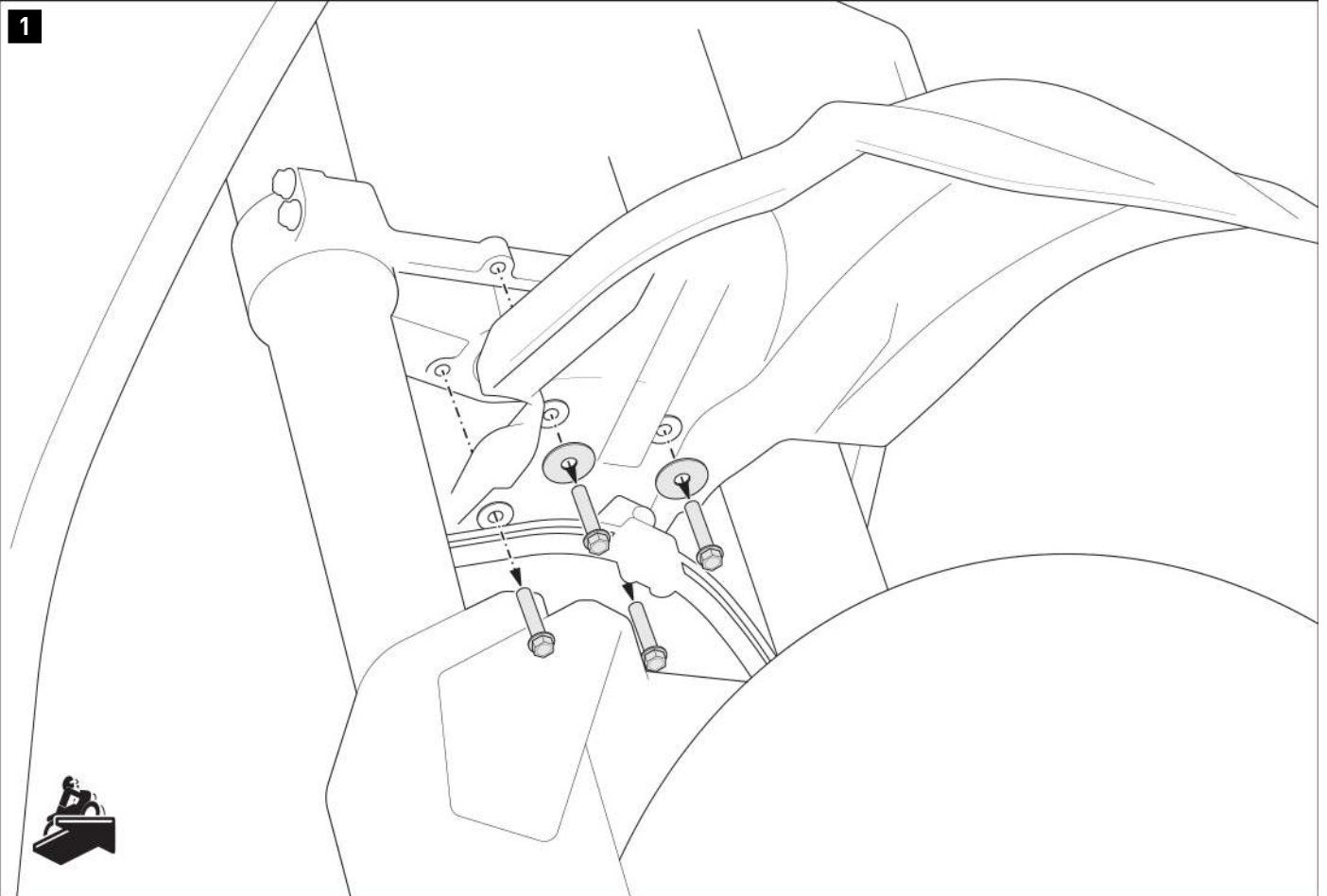

- ▲ **WARNING: Always wear eye and hand protection!**
- ▲ **WARNING: Always use the proper tools!**

YAMAHA XT700Z Extreme Edition only

Loosen the four original screws of the fender.



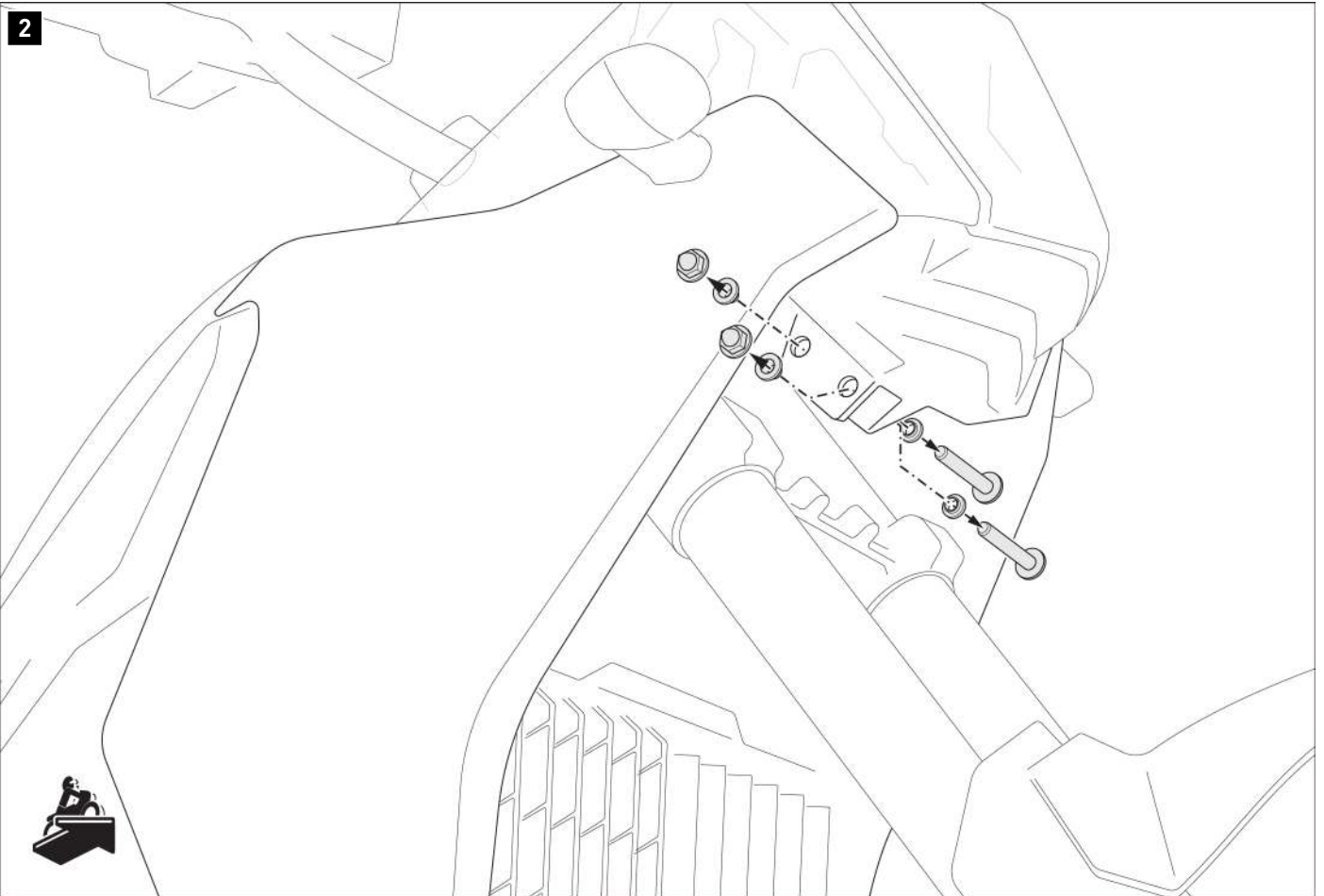

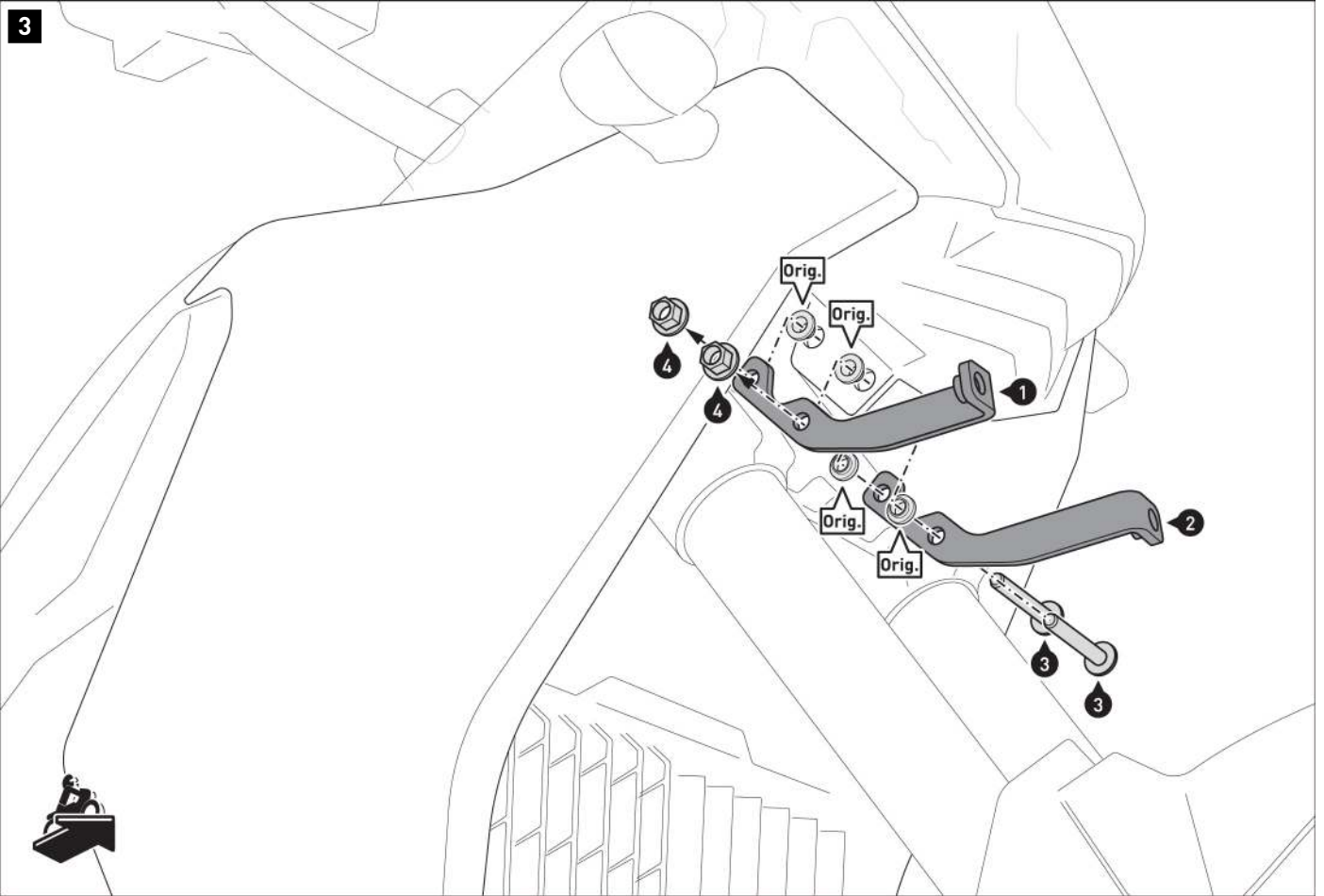

Remove the original parts from the attachment points shown.



Screw the mounting brackets (1/2) onto the vehicle using the original spacers (Orig.).
Do not tighten the screws (3) yet.

- 
×1
- 
×1
- 
×2
- 
18 Nm
- 
×2

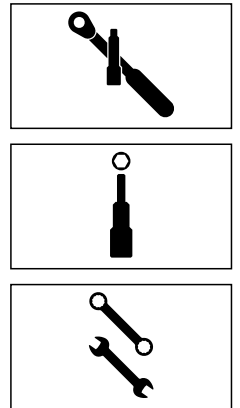

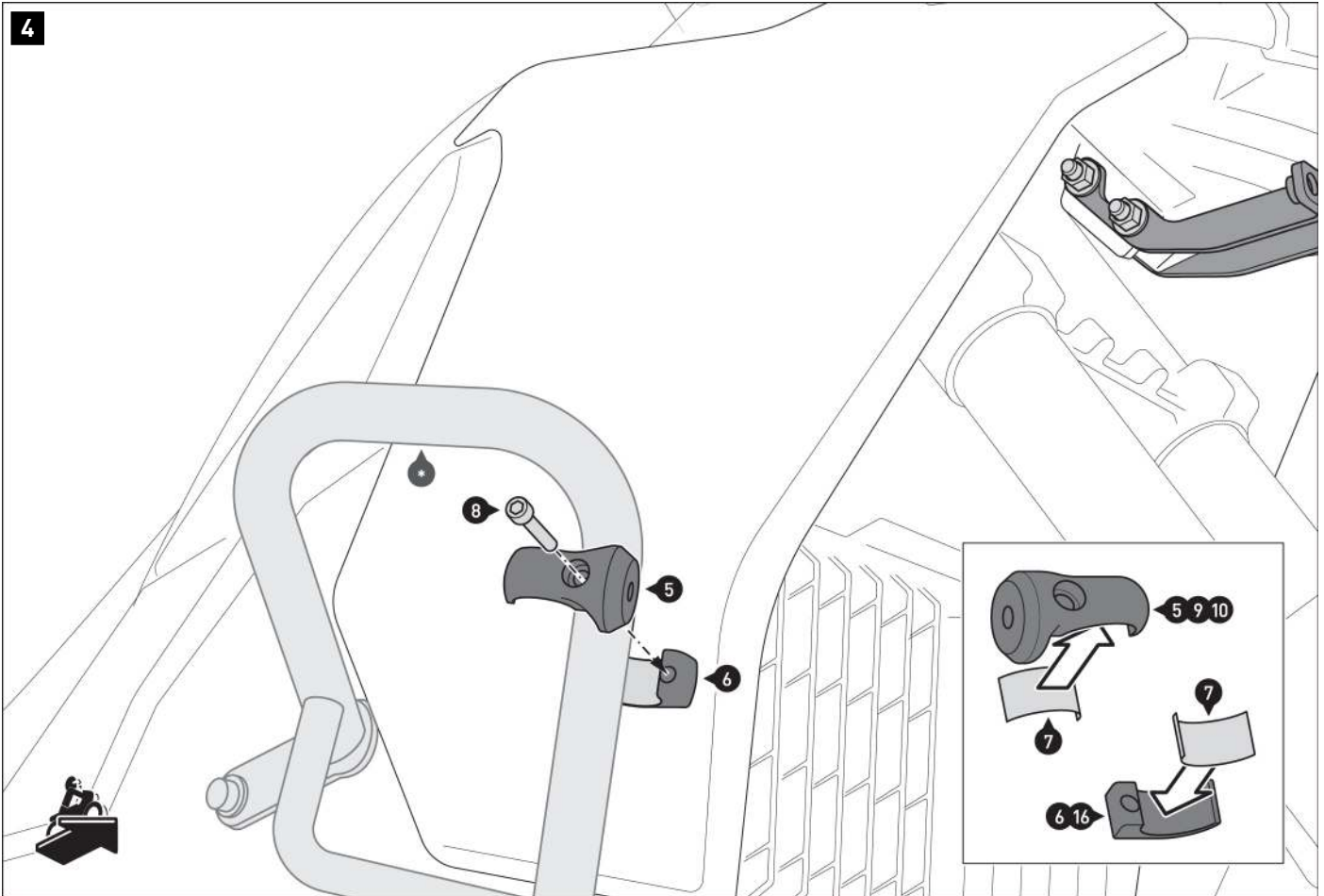

Glue the rubber strips [7] in clamps [5], [6], and [16] as well as in the clamps of the crash bars [9/10] as shown in the detailed drawing. Screw the clamps [5/6] onto the SW-MOTECH crash bar.

⚠ WARNING: Use a liquid threadlocker!
Do not tighten the screws [8] yet.



M 8 Nm

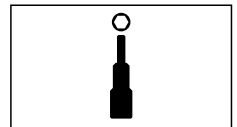

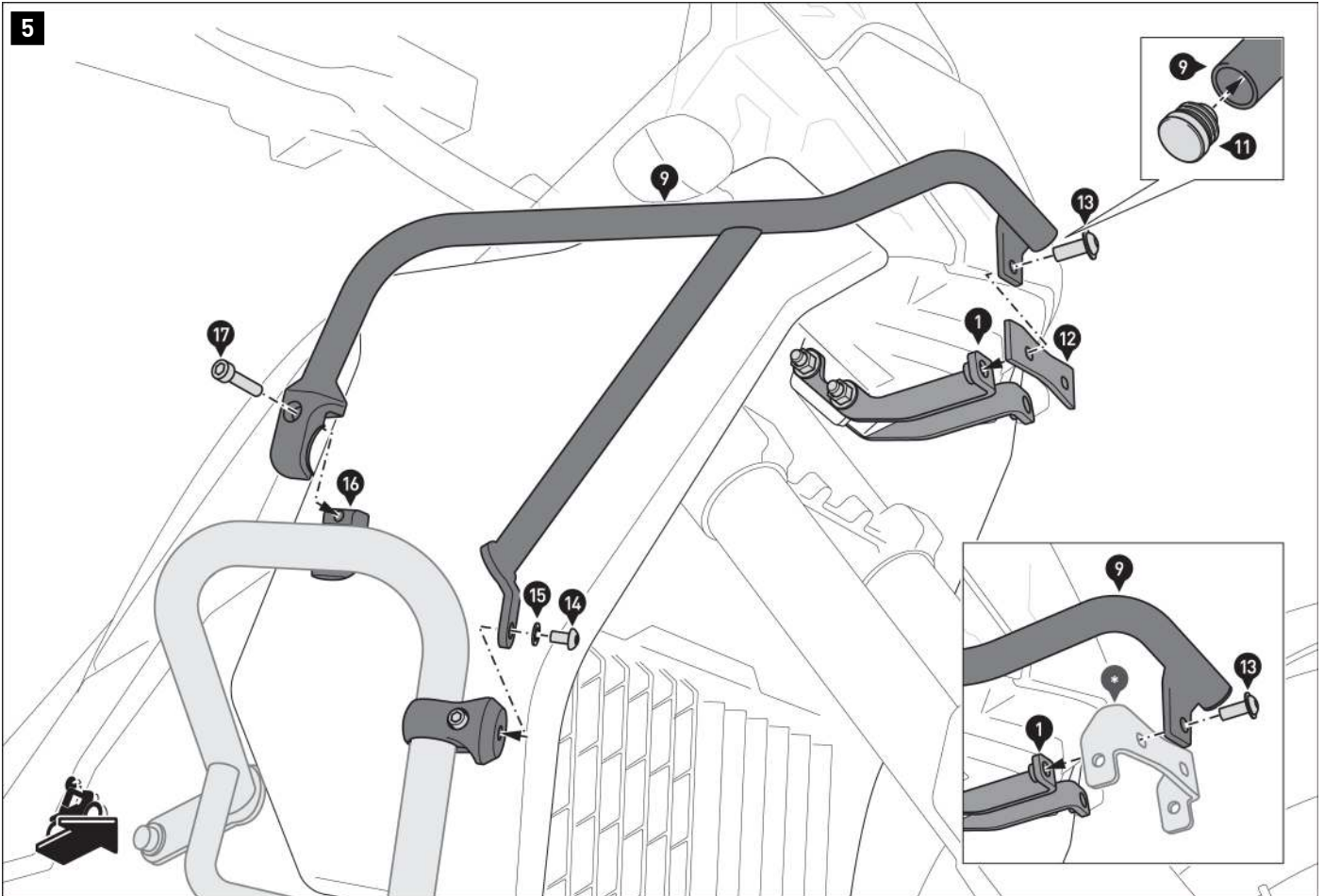

⚠ NOTE: When installing the crash bar with the SW-MOTECH headlight holder, use the mounting bracket (*) of the headlight holder as shown in the detailed drawing.

Insert the plastic plugs (11) into the crash bars (9/10).
Screw the crash bars (9/10) to the mounting brackets (1/2) and the SW-MOTECH crash bars.

⚠ WARNING: Use a liquid threadlocker!
Do not tighten screws (13), (14), and (17) yet.

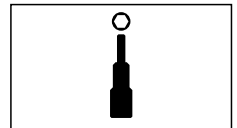
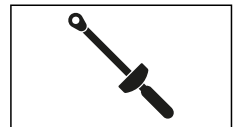

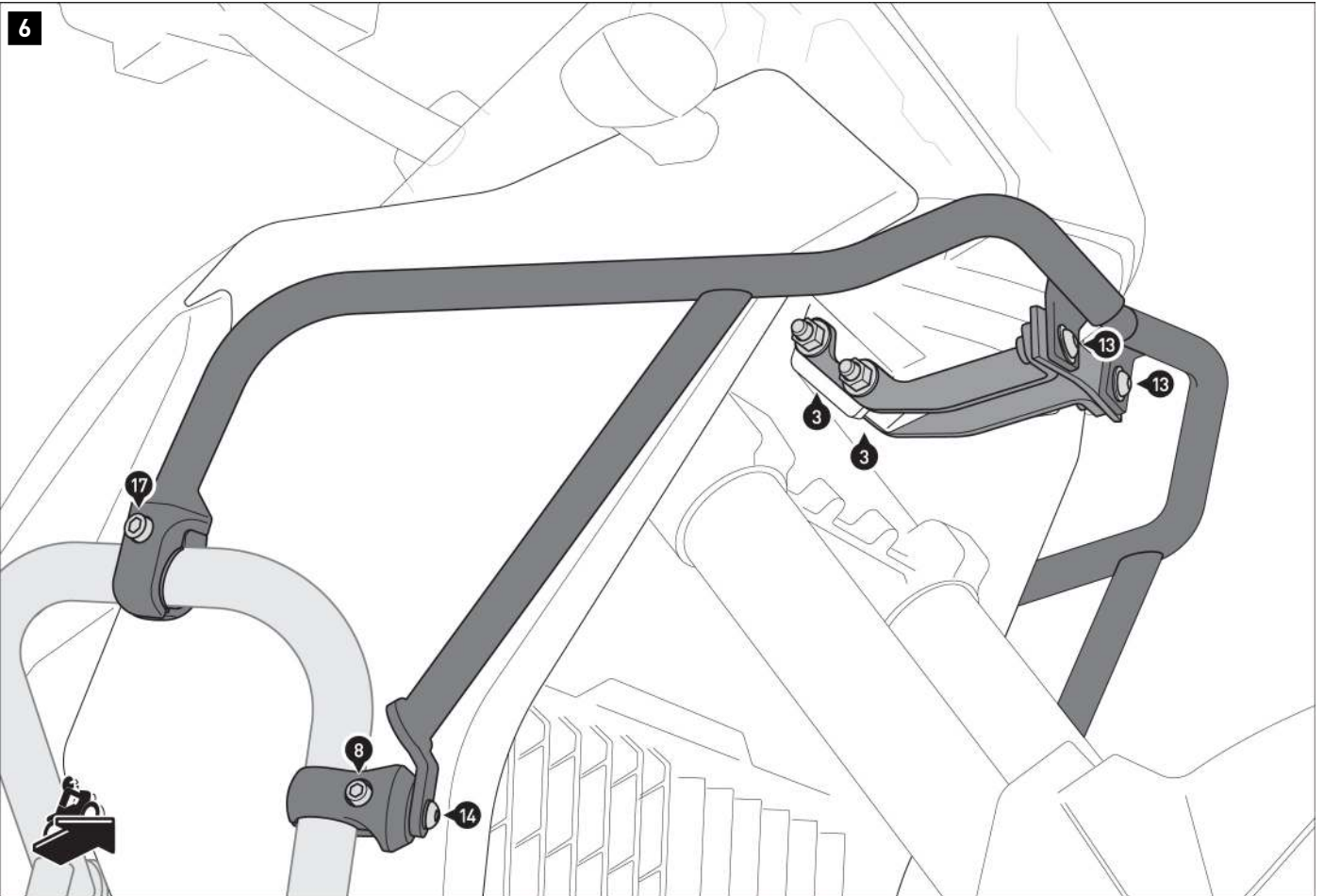

When all parts are seated without tension, tighten screws (3), (8), (13), (14) and (17) as specified in the mounting instructions.

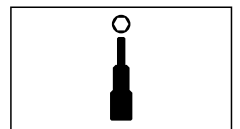

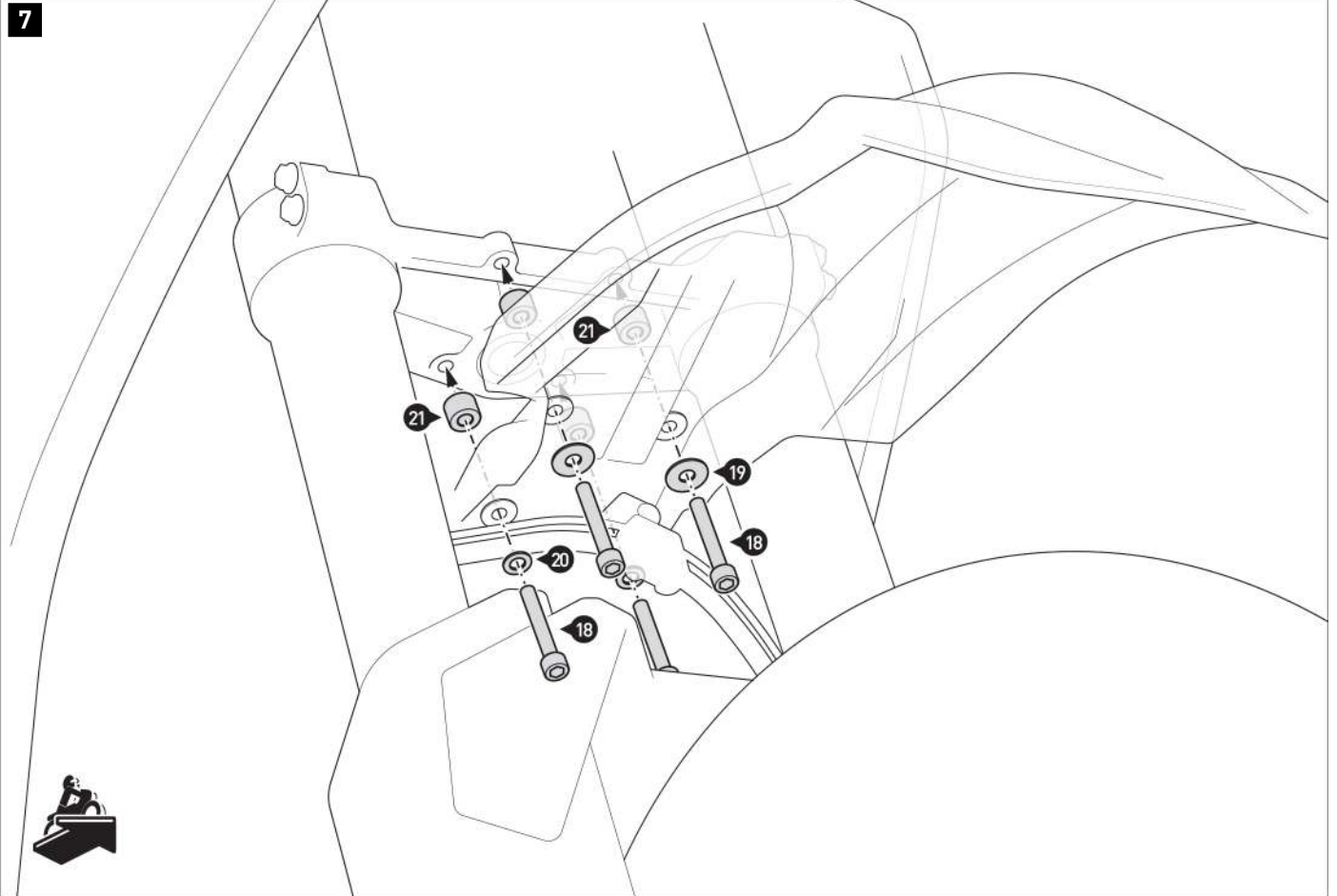

YAMAHA XT700Z Extreme Edition only

Screw the original spring with the parts shown under the fork bridge.
⚠ WARNING: Use a liquid threadlocker!
 Tighten screws (18) according to the manufacturer's instructions.

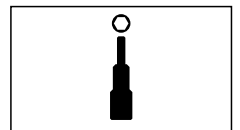
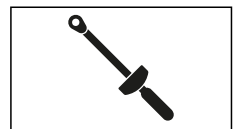

PRODUCT-SPECIFIC NOTES

⚠ WARNING: This product may inhibit cornering and ground clearance in cases of extreme inclination!

⚠ NOTE: Please observe the country-specific regulations for the registration/operation of your vehicle or any applicable TÜV regulations. After installation, parts subject to registration should be entered in the vehicle documents by your test center.

Art.-Nr. / Item No.: **SCT.06.799.10000**

Revision: **00** · Datum / Date: **11 - 2019**

Wasserpumpenschutz

Water pump protection

DEUTSCH - Vielen Dank, dass Sie sich für dieses Premium-Produkt von SW-MOTECH entschieden haben. Bitte besuchen Sie unseren Webshop für weitere Informationen wie Modellzuweisungen und PDF-Anbauanleitung. Erforderliche Dokumente (z. B. ABE) stehen als Download zur Verfügung.

Die Montage und/oder Wartung dieses Produkts erfordert ein gutes technisches Verständnis! Zu Ihrer eigenen Sicherheit empfiehlt SW-MOTECH, die Montage und/oder Wartung durch eine Fachwerkstatt durchführen zu lassen! SW-MOTECH übernimmt keine Haftung für Schäden, die durch eine unsachgemäße Montage und/oder Wartung verursacht wurden!

Beachten Sie alle in der Anbauanleitung angegebenen Hinweise und die für die Montage relevanten Informationen im Fahrzeughandbuch. Nichtbeachtung kann zu Schäden am Fahrzeug bzw. zur Gefährdung des Fahrers führen! Diese Anbauanleitung ist nach unserem derzeitigen Kenntnisstand verfasst worden. Rechtliche Ansprüche auf Richtigkeit bestehen nicht.

Dieses Produkt wurde für Fahrzeuge im Werkzustand entwickelt. Die Kompatibilität mit Original-Zubehörteilen bzw. den Zubehörteilen anderer Hersteller kann nicht gewährleistet werden. Stellen Sie des Weiteren VOR Montage dieses Produkts sicher, dass sich alle beweglichen Teile (z. B. die Kette) im ursprünglichen Wartungszustand befinden. Montiertes Zubehör kann das Fahrverhalten und/oder die Stabilität Ihres Fahrzeugs verändern.

ALLGEMEINE HINWEISE

Beachten Sie die landesspezifischen Vorschriften für Zulassung/Betrieb Ihres Fahrzeugs bzw. anwendbare TÜV-Vorschriften. Lassen Sie eintragungspflichtige Teile nach Montage durch Ihre Prüfstelle in die Fahrzeugpapiere eintragen.

VORBEREITUNG: Lesen Sie die Anbauanleitung aufmerksam und stellen Sie sicher, dass alle Teile der Stückliste vorhanden sind. Achten Sie darauf, dass Ihr Fahrzeug sicher steht und nicht umfallen kann. Schalten Sie den Motor ab und ziehen Sie den Zündschlüssel. Lassen Sie ggf. den Motor/Auspuff abkühlen. Klemmen Sie bei Arbeiten an der Elektrik die Fahrzeugbatterie ab. Verwenden Sie geeignetes Werkzeug. Lassen Sie sich von einer zweiten Person helfen.

MONTAGE: Alle vom Motorrad gelösten Teile und Verbindungen sind gemäß den Fahrzeugherstellereangaben wieder zu montieren oder durch die von SW-MOTECH gelieferten Teile zu ersetzen. Sichern Sie, falls nicht anderweitig definiert, alle Gewinde mit mittelfester, flüssiger Schraubensicherung.

Alle nicht durch SW-MOTECH definierten Anzugsmoment-Vorgaben müssen beim Fahrzeughersteller oder einer Fachwerkstatt erfragt werden!

FUNKTIONSKONTROLLE: Stellen Sie nach der Montage sicher, dass alle zuvor gelösten Teile und Verbindungen wieder ordnungsgemäß montiert wurden. Achten Sie außerdem auf die uneingeschränkte Freigängigkeit und einwandfreie Funktion sämtlicher Fahrzeugteile. Kabel, Züge und Schläuche dürfen nicht scheuern und/oder geklemmt werden. Führen Sie vor Fahrtbeginn eine umfassende Funktionskontrolle durch. Überprüfen Sie nach den ersten 50 km und anschließend in regelmäßigen Abständen das Anzugsmoment aller Schraubverbindungen und den ordnungsgemäßen Sitz des Produkts.

ENGLISH - Thank you for choosing this premium product from SW-MOTECH. Please visit our webshop for additional information, such as application charts and PDF mounting instructions. Any other documents that may be required (e.g. ABE certifications), are also available for download at our webshop.

Installation and/or maintenance of this product require good technical understanding! For your own safety SW-MOTECH recommends having installation and/or servicing carried out by a specialist workshop! SW-MOTECH assumes no liability for damage caused by improper installation and/or maintenance work!

Carefully follow all the directions given in the mounting instructions and pay attention to all relevant information in the vehicle manual during assembly. Nonconformance can lead to vehicle damage or even endanger the driver! These mounting instructions are written based on our current state of knowledge. Legal requirements for accuracy do not exist.

This product was developed for vehicles in their factory setting. Compatibility with original accessory parts or other manufacturers' accessory parts is not guaranteed. Furthermore, BEFORE installing this product, make sure that all moving parts (e.g. the chain) are in the original state of maintenance. Installed accessories can change the driving behaviour and/or stability of your vehicle.

GENERAL INFORMATION

Observe the country-specific regulations concerning vehicle registration/operation as well as TÜV regulations if applicable. If required, register installed parts in the vehicle documents through an appropriate inspection authority.

PREPARATION: Read the mounting instructions carefully and make sure that all items of the parts list are included. Make sure that your vehicle is parked safely and cannot fall over. Turn off the engine and remove the ignition key. Let the motor/exhaust cool off if necessary. Disconnect the vehicle battery when working on the electrical system. Use appropriate tools. Have another person to help you.

MOUNTING: All parts and connections removed from the vehicle must be reinstalled in accordance with the vehicle manufacturers' specifications or replaced by parts delivered by SW-MOTECH. Secure all threads, unless otherwise specified, with medium-strength liquid thread locker.

Torque specifications undefined by SW-MOTECH must be obtained from the vehicle manufacturer or by a specialist workshop!

FUNCTION CHECK: After installation make sure that all parts and connections previously removed are properly replaced. Also make sure that no moving parts are obstructed and no function of the vehicle is hindered in any way. Cables and hoses must not rub and/or be pinched. Before starting to ride, perform a comprehensive check of all functions. After the first 50 km and then at regular intervals, check the tightening torque of all screw connections and the proper fit of the product.

Konfektionierung durch / Packed by:

Datum der Konfektionierung / Date of packaging:



SW-MOTECH GmbH & Co. KG

Ernteweg 8/10
35282 Rauschenberg
Germany

Tel. / phone + 49 (0)6425 / 8168 - 050
Fax / fax + 49 (0)6425 / 8168 - 10

info@sw-motech.com
www.sw-motech.com

STÜCKLISTE / PARTS LIST

Schritt Step	Nr. No.	Art.-Nr. / Bezeichnung * Item No. / Description *	Artikel	Part	Anzahl Quantity **	N-m ***
1	(1)	SCT.06.799.001	Schutzplatte	Protection Plate	1 /1	
	(2)	SCT.06.799.002	Befestigungsbügel	Mounting Frame	1 /1	
	(3)	M5 x 6; DIN 6912	Innensechskantschraube, fl. Kopf; Edelstahl	Hexagon Socket Screw, short head; stainl. steel	2 /2	3
3	(4)	M6 x 55; DIN 6912	Innensechskantschraube, fl. Kopf	Hexagon Socket Screw, short head	2 /2	
	(5)	M6 x 50; DIN 6912	Innensechskantschraube, fl. Kopf	Hexagon Socket Screw, short head	1 /1	
	(6)	∅ 12 / ∅ 6,4 / h 27	Distanzbuchse	Spacer	3 /3	

8.8	Regelgewinde / Coarse Thread ∅						N-m	M4	M5	M6	M8	M10	M12	10.9	Regelgewinde / Coarse Thread ∅						N-m	M4	M5	M6	M8	M10	M12
	Stahl FK 8.8 / Steel CL 8.8														Stahl FK 10.9 / Steel CL 10.9												
	2,8	5,5	9,6	23	46	79		4,1	8,1	14	34	67	115														

* Alle Maßangaben in Millimeter. - ** Der zweite Wert gibt die Gesamtanzahl des jew. Artikels in der Lieferung an.
 *** **Keine Anzugsmomentvorgabe: Verwenden Sie das vom Fzg.-Hersteller definierte Anzugsmoment!** Das Standard-Anzugsmoment der Tabelle kann verwendet werden, wenn es den Fzg.-Hersteller-Vorgaben entspricht.

* All measurements in millimeters. - ** The second number indicates the total quantity of the part in the delivery.
 *** **No torque specifications: Use the torque defined by vehicle manufacturer!** The standard torque in this table can be used as long as it is within the vehicle manufacturer's specifications.



1

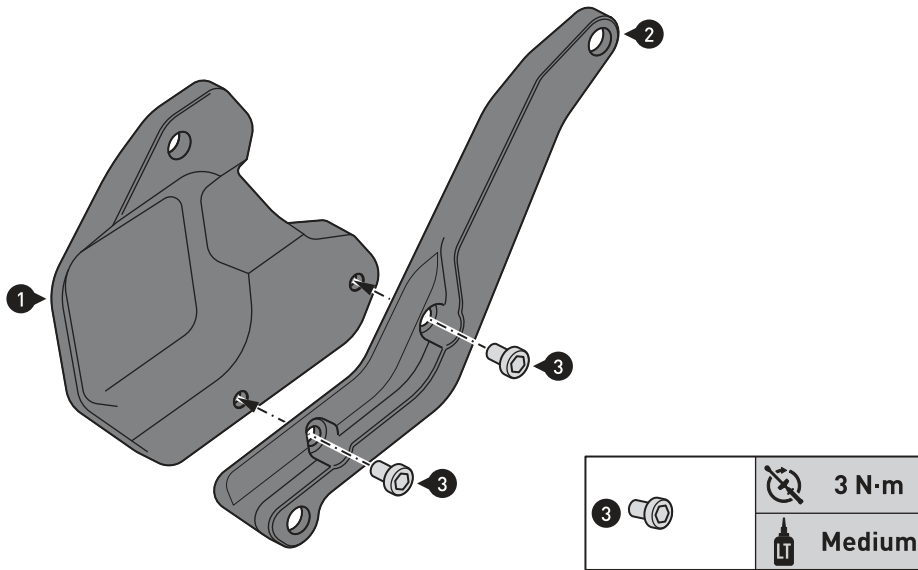

Verschrauben Sie die Teile miteinander, wie in der Zeichnung gezeigt.
ACHTUNG: Verwenden Sie flüssige Schraubensicherung!
 Ziehen Sie die Schrauben wie vorgegeben an.

Attach the parts together, as shown in the drawing.
ATTENTION: Use liquid thread locker!
 Tighten the screws as specified.

2

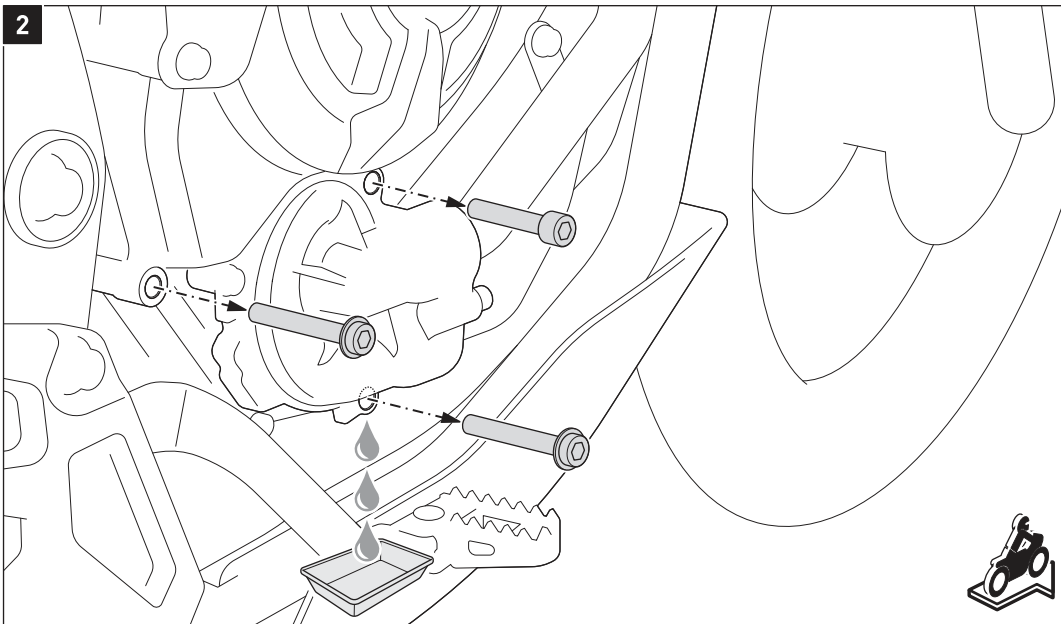

Entfernen Sie die gezeigten Schrauben von den Anbaupunkten.

ACHTUNG: Nach dem Entfernen der unteren Schraube können ein paar Tropfen Kühlflüssigkeit austreten!
 Um ein Austreten von Kühlflüssigkeit zu verhindern, sollte der Wasserpumpenschutz zeitnah montiert werden!

Remove the shown screws from the mounting points.

ATTENTION: After removing the lower screw, a few drops of coolant might leak!
 To prevent coolant leakage, the water pump protection should be promptly mounted!

3

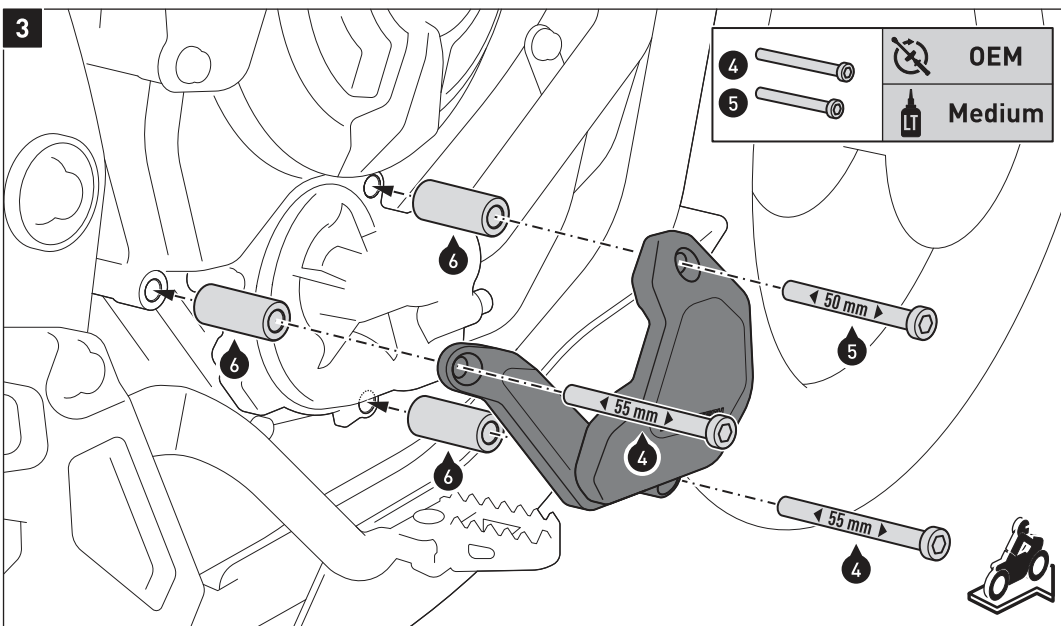

Verschrauben Sie den Wasserpumpenschutz am Fahrzeug, wie in der Zeichnung gezeigt.

ACHTUNG: Verwenden Sie flüssige Schraubensicherung!
 Ziehen Sie die Schrauben nach Herstellerangaben an.

Attach the water pump protection to the vehicle, as shown in the drawing.

ATTENTION: Use liquid thread locker!
 Tighten the original screws with the manufacturers' specified torque.

Item number: **MSS.06.799.10002/S**

Revision: **00** · Date: **10 - 2023**

Engine guard

 ~ 0.75 h.

EASY  DIFFICULT

ENGLISH Thank you for choosing this premium product from SW-MOTECH. Visit our online shop for more information (e.g. model assignments). Required documents (e.g. national type approval) are available there for you to download.

Please read and understand all the instructions, safety information and warnings in these mounting instructions before mounting and using the product in order to avoid injury and damage. Keep these mounting instructions for reference.

This product was developed for vehicles in factory condition. Compatibility with original accessories or accessories from other manufacturers cannot be guaranteed.

These mounting instructions have been prepared to the best of our current knowledge. No legal claims relating to accuracy can be made. Errors and omissions excepted. We reserve the right to make technical and design changes. The copyright is held by SW-MOTECH.

SAFETY WARNING SYMBOL

 This warning symbol is used in these mounting instructions to warn of deadly dangers, injuries or other hazards. The words **DANGER**, **WARNING** or **CAUTION** are used as part of this warning symbol to convey important safety messages and information relating to the installation and use of this product. These words, together with the safety warning symbol, mean:

 **DANGER:** Indicates a hazardous situation which, if not avoided, will result in death or serious injury!

 **WARNING:** Indicates a hazardous situation which, if not avoided, may result in death or serious injury!

 **CAUTION:** Indicates a hazardous situation which, if not avoided, may result in minor or moderate injury!

 **NOTE:** Important information, but not relating to a risk of death or injury (property damage only)!

GENERAL INFORMATION

 **WARNING:** Assembly and/or maintenance of this product requires advanced technical skill, appropriate tools, and a good understanding of tool usage and torque specifications. For your own safety, SW-MOTECH recommends having the assembly and/or maintenance carried out by a qualified and certified motorcycle workshop.

 **WARNING:** If you do choose to assemble this product yourself, carefully and fully read the mounting instructions before assembly and use, and follow all instructions to avoid serious injury or death. Also observe all relevant information in the vehicle manual when mounting or using the product. IF YOU DO NOT UNDERSTAND ANY PART OF THESE MOUNTING INSTRUCTIONS OR NEED AN EXPLANATION AS TO A SPECIFIC INSTRUCTION, DO NOT ATTEMPT TO INSTALL THIS PRODUCT WITHOUT CONSULTING SW-MOTECH FOR ASSISTANCE!

PREPARATION: Read the mounting instructions carefully and make sure that all parts on the parts list are available.

 **CAUTION:** Ensure that your vehicle is standing securely. Switch off the engine and remove the ignition key. Allow the engine/exhaust to cool down if necessary. Disconnect the battery when working on the electrical system. Only use proper tools and always wear safety goggles and gloves during assembly and maintenance. Have a second person help you with assembly and maintenance.

ASSEMBLY: All parts and connections removed from the vehicle must be reinstalled according to the vehicle manufacturer's specifications or replaced with parts and hardware supplied by SW-MOTECH.

 **WARNING:** Secure all threads with a medium-strength liquid threadlocker, unless otherwise specified.

 **DANGER:** Tightening torques not defined by SW-MOTECH must be obtained from the vehicle manufacturer or a certified motorbike workshop.



FUNCTIONAL CHECK: After mounting the product, ensure that no moving parts are obstructed and that the function of the vehicle is not impeded. Cables and hoses must not rub against each other and/or be hindered in any way.

 **WARNING:** Carry out a comprehensive functionality check before you start to drive. Check the tightening torque of all connections and the tight fit of the product after the first 50 km and then at regular intervals. Mounted accessories can change the handling and stability of the vehicle.



SW-MOTECH GmbH & Co. KG
Ernteweg 7-10
35282 Rauschenberg
Germany



 info@sw-motech.com
 www.sw-motech.com



Take note of the symbols and what they mean in the ASSEMBLY section. If the term OEM appears in the ASSEMBLY section, the vehicle manufacturer's specifications must be observed and applied.



If you have any questions, please don't hesitate to contact our Customer Service team or our distributors. You can find our telephone number and a list of our distributors in our online shop:

www.sw-motech.com



Use thread locker: Indicates that a thread must be coated with liquid thread locker. H (HIGH): high strength; M (MEDIUM): medium strength; L (LOW): low strength.



Tighten/note the tightening torque information:

Indicates the tightening torque of a part specified by SW-MOTECH or the vehicle manufacturer (OEM).

PARTS LIST - READ AND KEEP MOUNTING INSTRUCTIONS!

2

1



MSS.06.799.013.11

1/1

2



MSS.06.799.014.11

1/1

3



M6 x 25; DIN 933
SC.ST.06.025.01.933.088

4/4

4



ø 6.4; DIN 125
US.ST.064.01.125

4/4

5



Ø 20 / ø 8.4 / h 5
DB.ST.200.084.005.01

2/4

3

6



MSS.06.799.012.11

1/1

7



M8 x 35; DIN 6921
SC.ST.08.035.01.6921.109

2/2

8



Ø 20 / ø 8.4 / h 5
DB.ST.200.084.005.01

2/4

4

9



MSS.06.799.900.03.01

1/1

10



M8 x 16; DIN 933
SC.ST.08.016.01.933.109

7/7

11



ø 8.4; DIN 125
US.ST.084.01.125

7/7

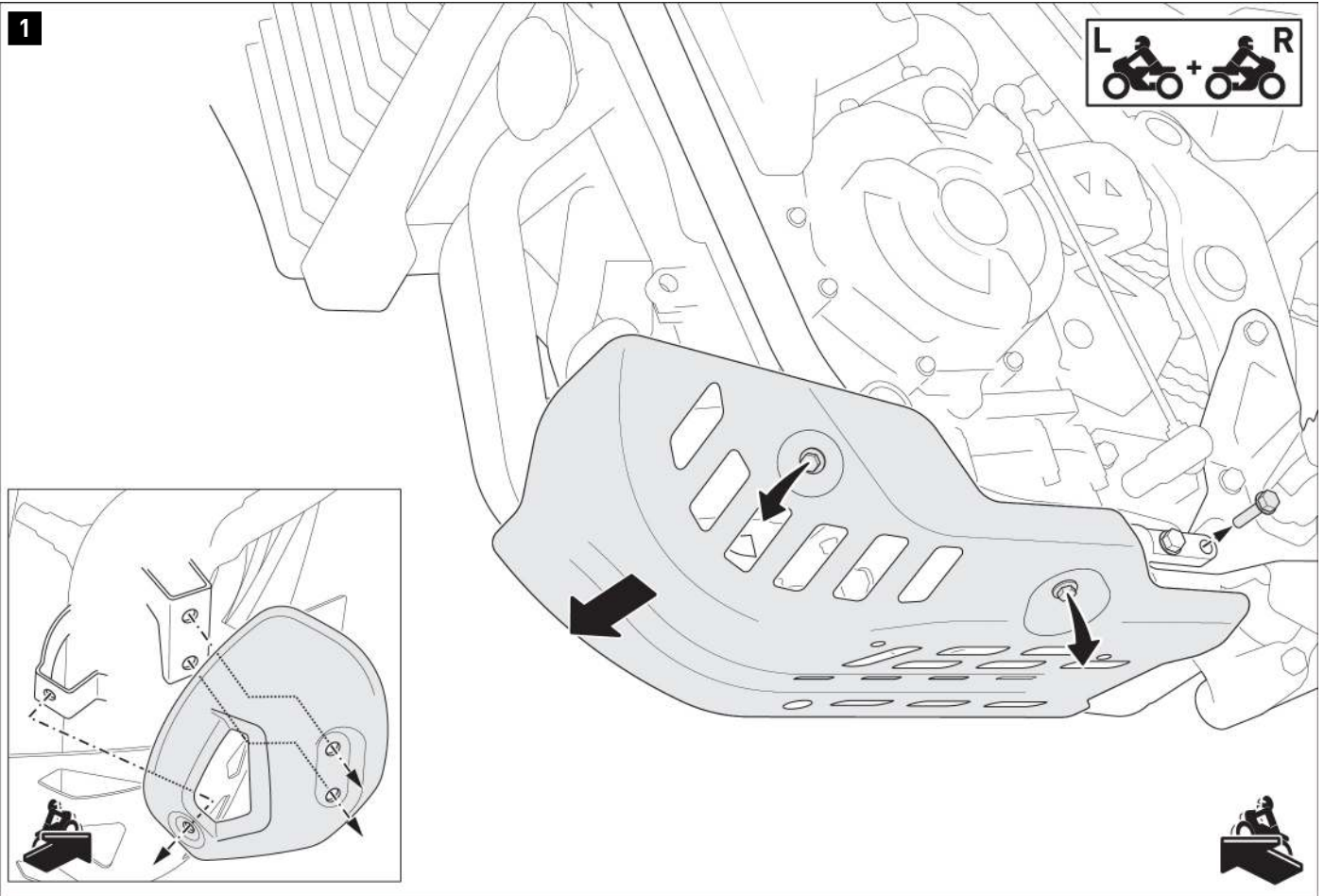

- ▲ **WARNING: Always wear eye and hand protection!**
- ▲ **WARNING: Always use the proper tools!**

Loosen the indicated screws on both sides of the original engine guard and remove it from the vehicle.

Remove the manifold cover on the right side of the vehicle as shown in the detailed drawing.

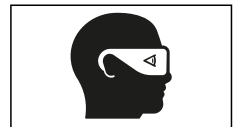

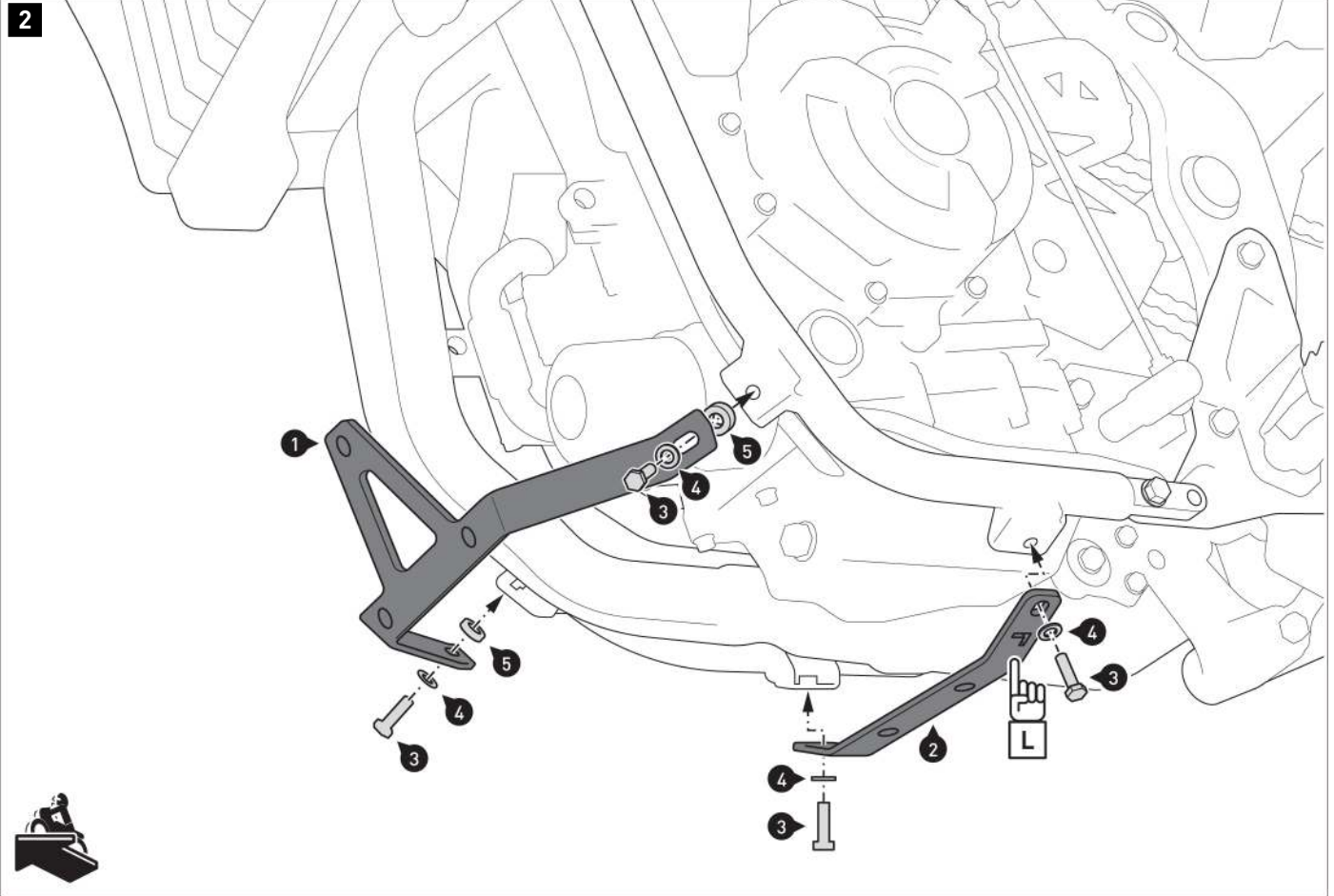

Screw the front [1] and middle [2] mounting brackets (L mark on the left side of the vehicle) to the vehicle frame.

▲ WARNING: Use a liquid threadlocker!

Tighten the screws [3] according to the manufacturer's instructions.

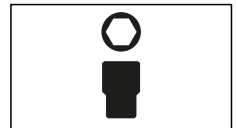
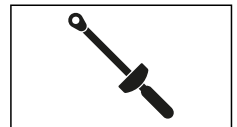

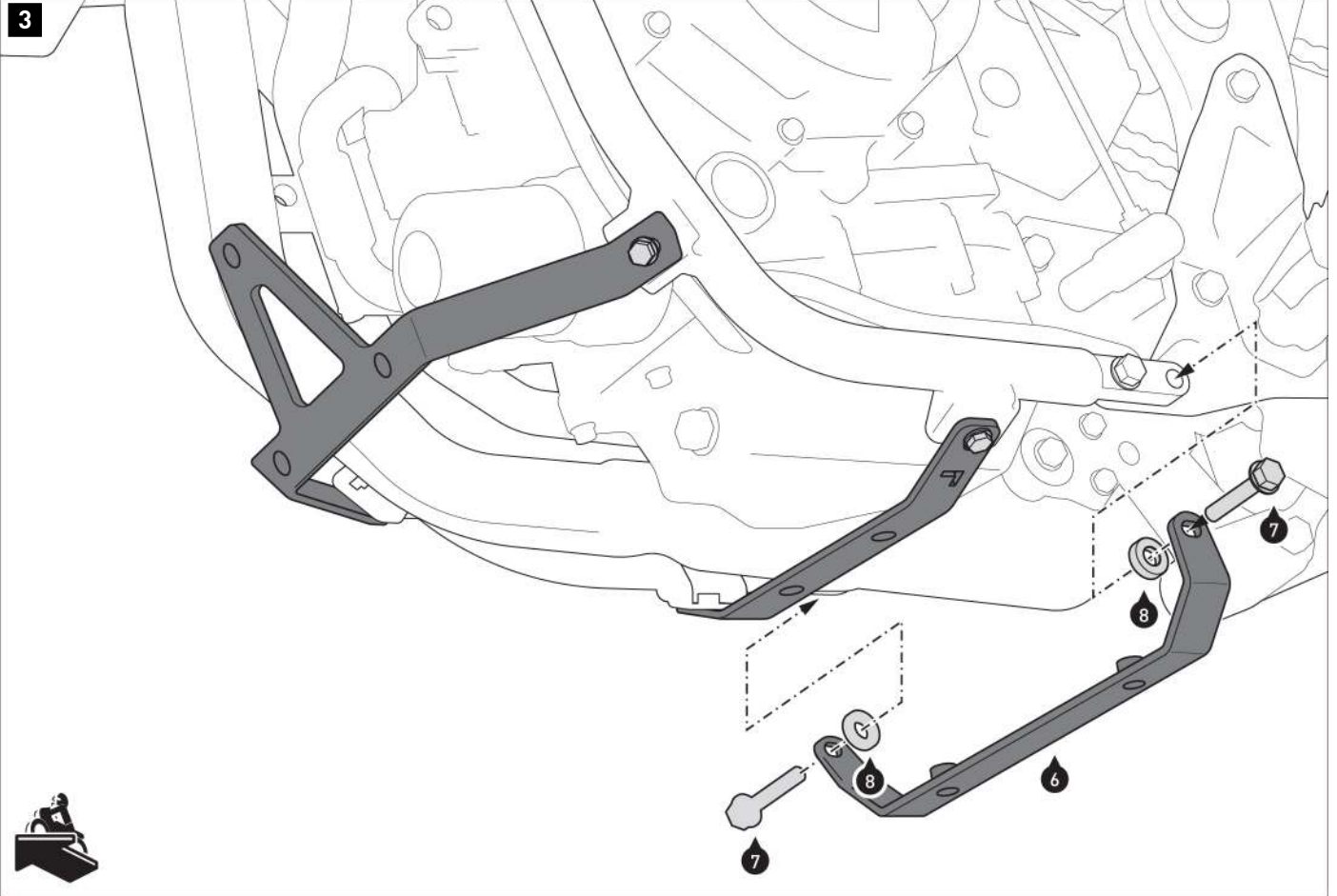

Screw the rear mounting bracket (6) to the vehicle frame.
▲ WARNING: Use a liquid threadlocker!
 Do not tighten the screws (7) yet.

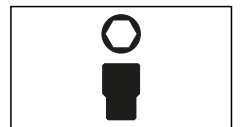
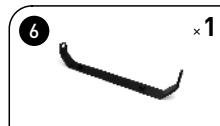

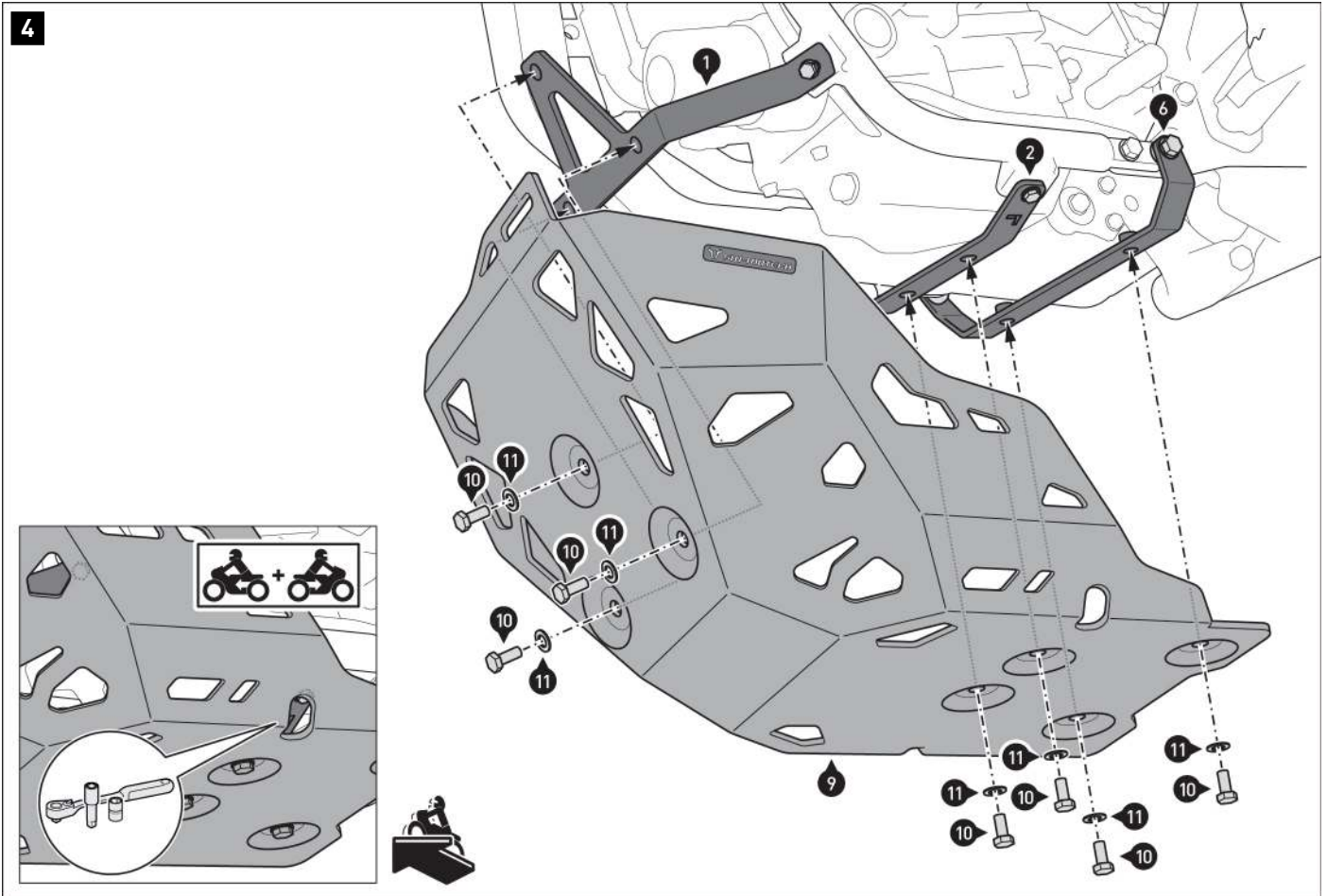

Screw the engine guard (9) to mounting brackets (1), (2) and (6) as shown in the drawing.

▲ WARNING: Use liquid thread locker!

When all components have been loosely attached, tighten the screws (10) as specified.

Then tighten screws (3) [see step [2]] and (7) [see step [3]] according to the manufacturer's instructions.

Note the opening for tightening the screws (3) indicated in the detailed drawing.



M 18 Nm

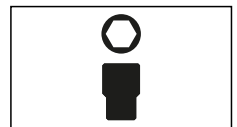
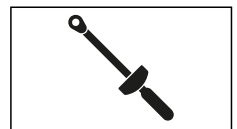

PRODUCT-SPECIFIC NOTES

⚠ WARNING: Ground clearance may be restricted by this product! Particular caution is required when cornering at extreme inclination and/or driving on uneven ground (e.g. curbs and bumps)!

⚠ WARNING: Motorcycle exhaust pipes often have large geometric tolerances. Make sure that there is sufficient distance between all parts in the affected areas!

⚠ NOTE: *Please observe the country-specific regulations for the registration/operation of your vehicle or any applicable TÜV regulations. After installation, parts subject to registration should be entered in the vehicle documents by your test center.*

Item number: HDG.00.220.80901/B

Revision: 00 · Date: 01 - 2024

Handguard mounting kit

 ~ 0.5 h.

EASY     DIFFICULT

ENGLISH Thank you for choosing this premium product from SW-MOTECH. Visit our online shop for more information (e.g. model assignments). Required documents (e.g. national type approval) are available there for you to download.

Please read and understand all the instructions, safety information and warnings in these mounting instructions before mounting and using the product in order to avoid injury and damage. Keep these mounting instructions for reference.

This product was developed for vehicles in factory condition. Compatibility with original accessories or accessories from other manufacturers cannot be guaranteed.

These mounting instructions have been prepared to the best of our current knowledge. No legal claims relating to accuracy can be made. Errors and omissions excepted. We reserve the right to make technical and design changes. The copyright is held by SW-MOTECH.

SAFETY WARNING SYMBOL

 This warning symbol is used in these mounting instructions to warn of deadly dangers, injuries or other hazards. The words **DANGER**, **WARNING** or **CAUTION** are used as part of this warning symbol to convey important safety messages and information relating to the installation and use of this product. These words, together with the safety warning symbol, mean:

 **DANGER:** Indicates a hazardous situation which, if not avoided, will result in death or serious injury!

 **WARNING:** Indicates a hazardous situation which, if not avoided, may result in death or serious injury!

 **CAUTION:** Indicates a hazardous situation which, if not avoided, may result in minor or moderate injury!

 **NOTE:** Important information, but not relating to a risk of death or injury (property damage only)!

GENERAL INFORMATION

 **WARNING:** Assembly and/or maintenance of this product requires advanced technical skill, appropriate tools, and a good understanding of tool usage and torque specifications. For your own safety, SW-MOTECH recommends having the assembly and/or maintenance carried out by a qualified and certified motorcycle workshop.

 **WARNING:** If you do choose to assemble this product yourself, carefully and fully read the mounting instructions before assembly and use, and follow all instructions to avoid serious injury or death. Also observe all relevant information in the vehicle manual when mounting or using the product. IF YOU DO NOT UNDERSTAND ANY PART OF THESE MOUNTING INSTRUCTIONS OR NEED AN EXPLANATION AS TO A SPECIFIC INSTRUCTION, DO NOT ATTEMPT TO INSTALL THIS PRODUCT WITHOUT CONSULTING SW-MOTECH FOR ASSISTANCE!

PREPARATION: Read the mounting instructions carefully and make sure that all parts on the parts list are available.

 **CAUTION:** Ensure that your vehicle is standing securely. Switch off the engine and remove the ignition key. Allow the engine/exhaust to cool down if necessary. Disconnect the battery when working on the electrical system. Only use proper tools and always wear safety goggles and gloves during assembly and maintenance. Have a second person help you with assembly and maintenance.

ASSEMBLY: All parts and connections removed from the vehicle must be reinstalled according to the vehicle manufacturer's specifications or replaced with parts and hardware supplied by SW-MOTECH.

 **WARNING:** Secure all threads with a medium-strength liquid threadlocker, unless otherwise specified.

 **DANGER:** Tightening torques not defined by SW-MOTECH must be obtained from the vehicle manufacturer or a certified motorbike workshop.

FUNCTIONAL CHECK: After mounting the product, ensure that no moving parts are obstructed and that the function of the vehicle is not impeded. Cables and hoses must not rub against each other and/or be hindered in any way.

 **WARNING:** Carry out a comprehensive functionality check before you start to drive. Check the tightening torque of all connections and the tight fit of the product after the first 50 km and then at regular intervals. Mounted accessories can change the handling and stability of the vehicle.



SW-MOTECH GmbH & Co. KG
Ernteweg 7-10
35282 Rauschenberg
Germany



info@sw-motech.com
www.sw-motech.com



Take note of the symbols and what they mean in the ASSEMBLY section. If the term OEM appears in the ASSEMBLY section, the vehicle manufacturer's specifications must be observed and applied.



If you have any questions, please don't hesitate to contact our Customer Service team or our distributors. You can find our telephone number and a list of our distributors in our online shop:

www.sw-motech.com



Use thread locker: Indicates that a thread must be coated with liquid thread locker. H (HIGH): high strength; M (MEDIUM): medium strength; L (LOW): low strength.



Tighten/note the tightening torque information:

Indicates the tightening torque of a part specified by SW-MOTECH or the vehicle manufacturer (OEM).



Do not use thread lock: Indicates that no liquid thread lock should be used at this point.

PARTS LIST - READ AND KEEP MOUNTING INSTRUCTIONS!

1

1



HDG.00.220.907.01.25

 1/1

2



HDG.00.220.908.01.25

 1/1

3



HDG.06.799.001L.25

 1/1

4



HDG.06.799.001R.25

 1/1

5



M6 x 20; DIN 7380
SC.ST.06.020.02.7380.109

 2/2

2

6



HDG.00.220.024L.25

 1/1

7



HDG.00.220.024R.25

 1/1

8



M8 x 35; DIN 6912
SC.ST.08.035.02.6912.088

 2/2

9



HDG.00.220.011.25

 2/2

10



HDG.00.220.074.35

 2/2

11



M16
LVG.06.861.001.35

 2/2

3

12



M6 x 22; DIN 7991
SC.ST.06.022.48.7991.088

 2/2

13



ø 6.4; DIN 9021
US.ST.064.02.9021

 2/2

14



M6; DIN 6927
MU.ST.06.02.6927.08

 2/2

1

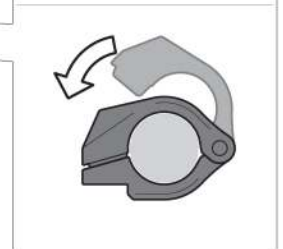
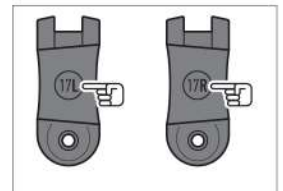
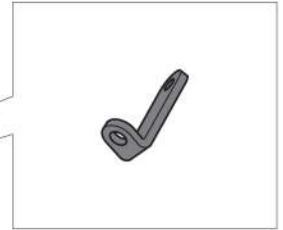
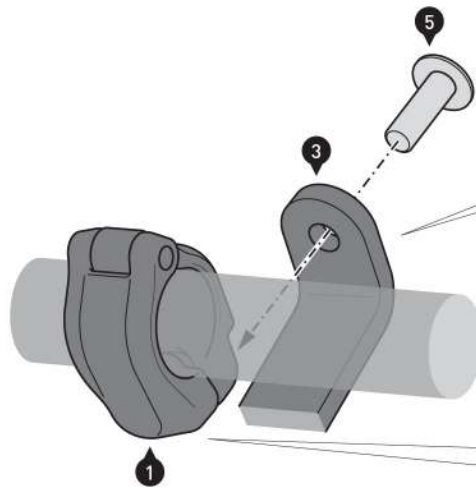

⚠ WARNING: Since the handguard mounting kit is installed in a safety-relevant area of the vehicle, SW-MOTECH recommends having the installation/maintenance of the product carried out by a qualified specialist workshop.

⚠ WARNING: Always wear eye and hand protection!
⚠ WARNING: Always use the proper tools!

⚠ NOTE: Installation is shown on the left side. Repeat the installation with the corresponding parts on the right side of the handlebar.

⚠ NOTE: The handlebar shown serves as an example.

⚠ NOTE: The connecting plate (3) shown in the drawing serves as an example. The correct representation and orientation of the connecting plate are shown in the detailed drawing on the right.

⚠ NOTE: Pay attention to the L/R markings on the clamps (1/2). Attach the clamp with the L marking on the left side of the handlebar in the direction of travel; attach the clamp with the R engraving to the right side of the handlebar in the direction of travel.

Place the clamps (1/2) around the handlebars at the locations shown in the detailed drawing above.

LOOSELY screw the connecting plates (3/4) to the clamps (1/2). The clamps (1/2) must be able to be moved for positioning.

⚠ WARNING: Use a liquid threadlocker!
 Tighten the screws (5) hand-tight.



M 8 Nm

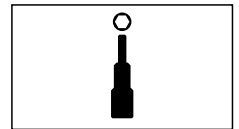
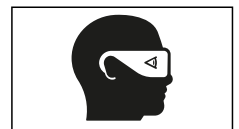

2

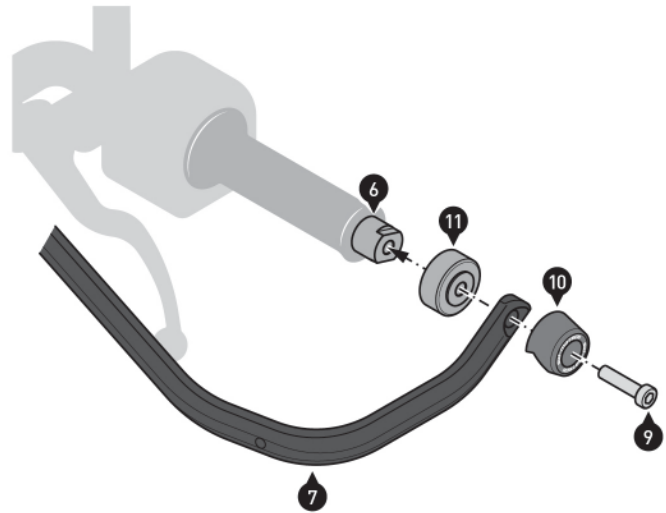
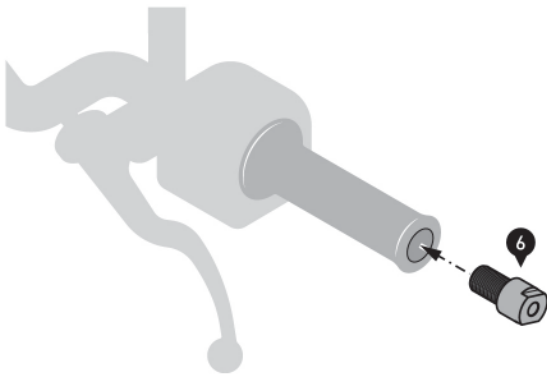
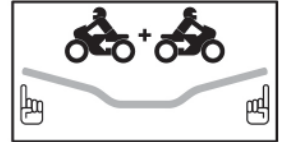

Remove the original end weights and handguards if mounted.
Make sure the handlebar ends and the inside of the handlebars are clear.

Screw the adapters (6) onto the vehicle as shown in the drawing above.

▲ WARNING: Use a liquid threadlocker!

Tighten the adapters (6) as specified in the mounting instructions.

Install the brackets (7/8) on the handlebar ends as shown in the drawing below.

To do this, tighten the screw (9) enough so that the brackets (7/8) can still be readjusted.

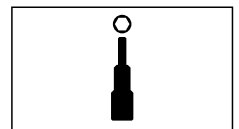
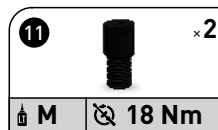

3

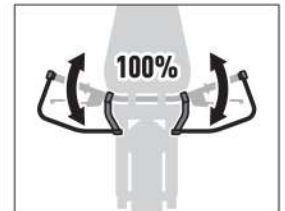
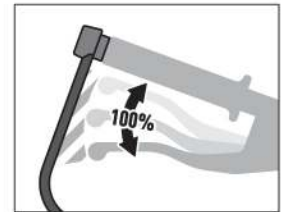
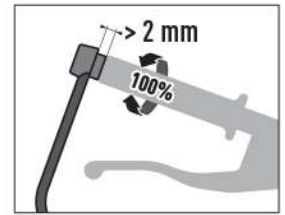
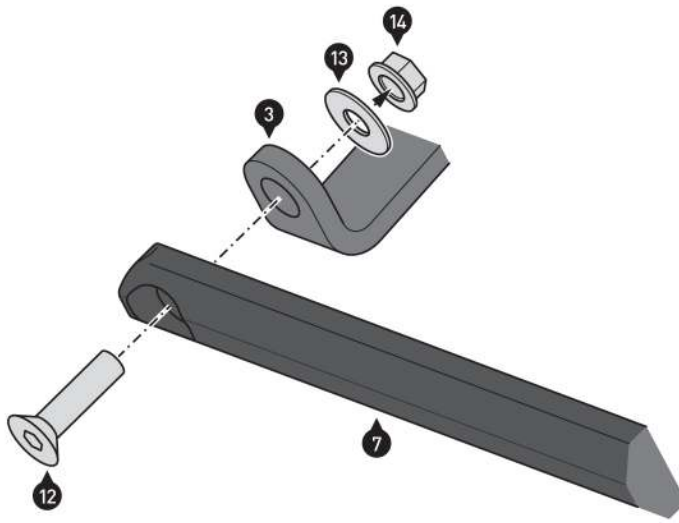

Screw the inner ends of the brackets (7/8) to the connecting plates (3/4). Do not tighten the screws (12) yet.

Now position the brackets (7/8) according to your driving ergonomics and tighten all screws in the following order and as specified in the mounting instructions: (12), (5), (9).

⚠ DANGER: If there is not enough space after installation of all components, the brake and clutch unit must be moved a few millimeters towards the end or middle of the handlebar!

⚠ DANGER: After installation, make sure that all switch and control units, especially the throttle assembly, brake lever, emergency stop switch and clutch, function properly and are easy to use! Also make sure that the handlebars can be fully turned in both directions. If parts of the product come into contact with the tank or other vehicle components when the steering wheel is at full lock, repositioning the product or the handlebars is absolutely necessary! Make sure that the installation complies with the vehicle manufacturer's specifications! DO NOT ride your vehicle if the switch and control units are not functioning correctly or cannot be operated correctly! BEFORE every ride, carry out a complete functional check of the handlebars and all fittings!

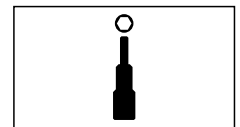
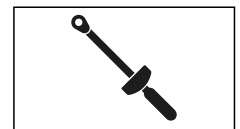

PRODUCT-SPECIFIC NOTES

⚠ NOTE: *Observe the country-specific regulations for the registration/operation of your vehicle or applicable TÜV regulations. After assembly, have parts that are subject to registration entered in the vehicle documents by your test centre.*

Item number: HDG.00.220.10300/B

Revision: 01 · Date: 12 - 2023

Sport handguard shell set

 ~ 0.25 h.

EASY      DIFFICULT

ENGLISH Thank you for choosing this premium product from SW-MOTECH. Visit our online shop for more information (e.g. model assignments). Required documents (e.g. national type approval) are available there for you to download.

Please read and understand all the instructions, safety information and warnings in these mounting instructions before mounting and using the product in order to avoid injury and damage. Keep these mounting instructions for reference.

This product was developed for vehicles in factory condition. Compatibility with original accessories or accessories from other manufacturers cannot be guaranteed.

These mounting instructions have been prepared to the best of our current knowledge. No legal claims relating to accuracy can be made. Errors and omissions excepted. We reserve the right to make technical and design changes. The copyright is held by SW-MOTECH.

SAFETY WARNING SYMBOL

 This warning symbol is used in these mounting instructions to warn of deadly dangers, injuries or other hazards. The words DANGER, WARNING or CAUTION are used as part of this warning symbol to convey important safety messages and information relating to the installation and use of this product. These words, together with the safety warning symbol, mean:

 **DANGER:** Indicates a hazardous situation which, if not avoided, will result in death or serious injury!

 **WARNING:** Indicates a hazardous situation which, if not avoided, may result in death or serious injury!

 **CAUTION:** Indicates a hazardous situation which, if not avoided, may result in minor or moderate injury!

 **NOTE:** Important information, but not relating to a risk of death or injury (property damage only)!

GENERAL INFORMATION

 **WARNING:** Assembly and/or maintenance of this product requires advanced technical skill, appropriate tools, and a good understanding of tool usage and torque specifications. For your own safety, SW-MOTECH recommends having the assembly and/or maintenance carried out by a qualified and certified motorcycle workshop.

 **WARNING:** If you do choose to assemble this product yourself, carefully and fully read the mounting instructions before assembly and use, and follow all instructions to avoid serious injury or death. Also observe all relevant information in the vehicle manual when mounting or using the product. IF YOU DO NOT UNDERSTAND ANY PART OF THESE MOUNTING INSTRUCTIONS OR NEED AN EXPLANATION AS TO A SPECIFIC INSTRUCTION, DO NOT ATTEMPT TO INSTALL THIS PRODUCT WITHOUT CONSULTING SW-MOTECH FOR ASSISTANCE!

PREPARATION: Read the mounting instructions carefully and make sure that all parts on the parts list are available.

 **CAUTION:** Ensure that your vehicle is standing securely. Switch off the engine and remove the ignition key. Allow the engine/exhaust to cool down if necessary. Disconnect the battery when working on the electrical system. Only use proper tools and always wear safety goggles and gloves during assembly and maintenance. Have a second person help you with assembly and maintenance.

ASSEMBLY: All parts and connections removed from the vehicle must be reinstalled according to the vehicle manufacturer's specifications or replaced with parts and hardware supplied by SW-MOTECH.

 **WARNING:** Secure all threads with a medium-strength liquid threadlocker, unless otherwise specified.

 **DANGER:** Tightening torques not defined by SW-MOTECH must be obtained from the vehicle manufacturer or a certified motorbike workshop.



FUNCTIONAL CHECK: After mounting the product, ensure that no moving parts are obstructed and that the function of the vehicle is not impeded. Cables and hoses must not rub against each other and/or be hindered in any way.

 **WARNING:** Carry out a comprehensive functionality check before you start to drive. Check the tightening torque of all connections and the tight fit of the product after the first 50 km and then at regular intervals. Mounted accessories can change the handling and stability of the vehicle.



SW-MOTECH GmbH & Co. KG
Ernteweg 7-10
35282 Rauschenberg
Germany



 info@sw-motech.com
 www.sw-motech.com

LEGEND OVERVIEW - READ AND KEEP MOUNTING INSTRUCTIONS!



Take note of the symbols and what they mean in the ASSEMBLY section. If the term OEM appears in the ASSEMBLY section, the vehicle manufacturer's specifications must be observed and applied.



If you have any questions, please don't hesitate to contact our Customer Service team or our distributors. You can find our telephone number and a list of our distributors in our online shop:
www.sw-motech.com



Do not use thread lock: Indicates that no liquid thread lock should be used at this point.



Tighten by hand: Indicates that the attachment must be carefully tightened by hand.

PARTS LIST - READ AND KEEP MOUNTING INSTRUCTIONS!

1

1



HDG.00.220.004L.02

 **1/1**

2



HDG.00.220.004R.02

 **1/1**

3



HDG.00.220.006.02

 **4/4**

4



M3,5 x 12
SC.ST.035.012.02

 **8/8**

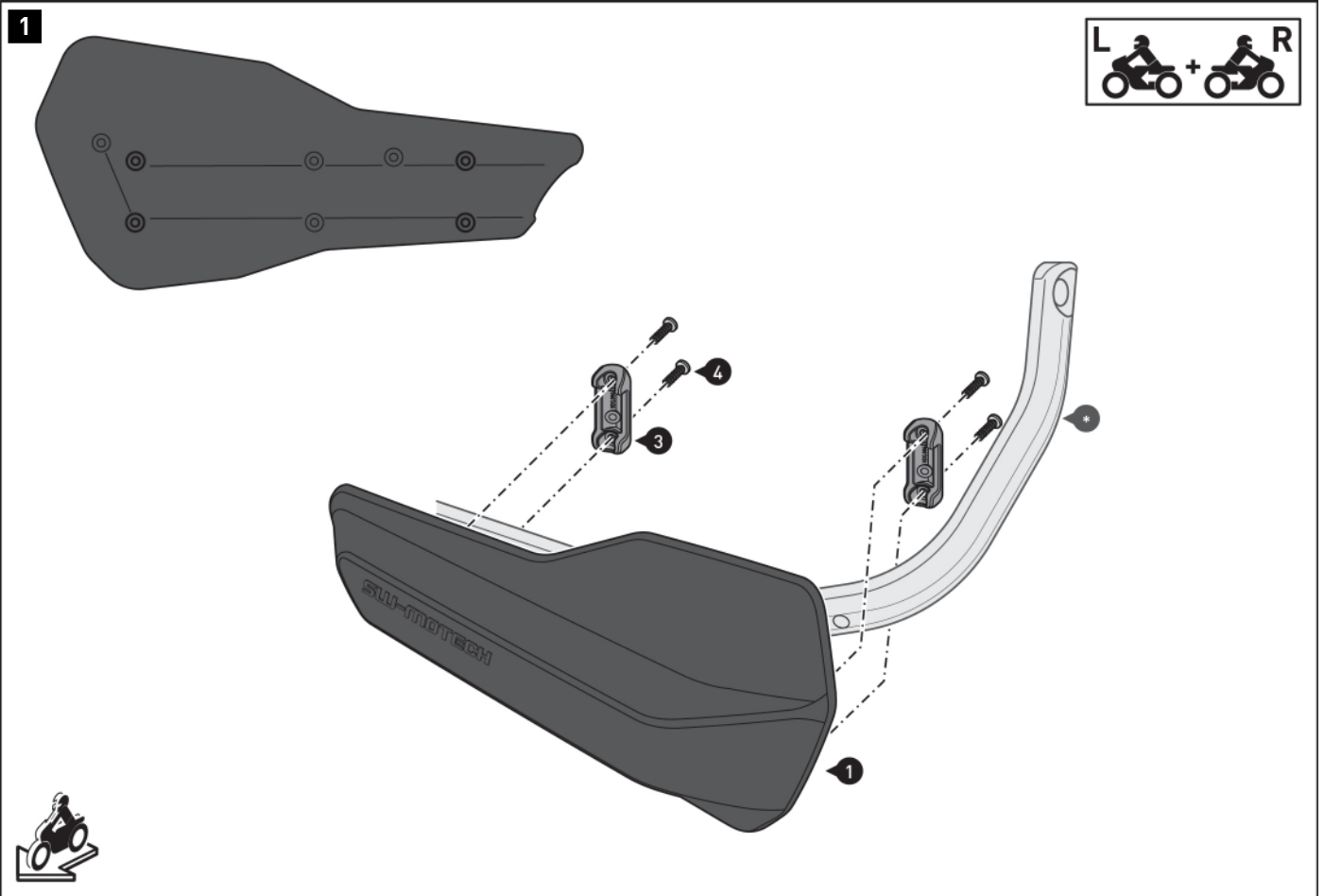

⚠ WARNING: Always wear eye and hand protection!
⚠ WARNING: Always use the proper tools!

⚠ NOTE: Installation is shown on the left side. Repeat the installation with the corresponding parts on the right side of the handlebar.

Screw the sports hand-guard shells (1/2) onto the brackets (*). Carefully tighten the screws (4) hand-tight (max. 1 Nm).

⚠ WARNING: Tightening too tightly can damage the plastic parts!

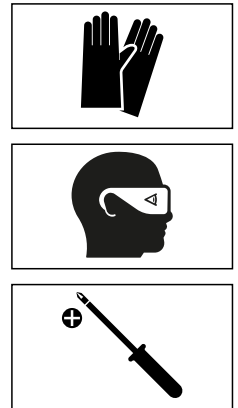
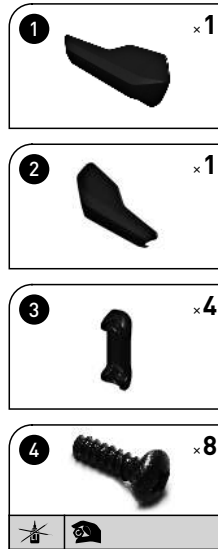

PRODUCT-SPECIFIC NOTES

⚠ NOTE: *Observe the country-specific regulations for the registration/operation of your vehicle or applicable TÜV regulations. After assembly, have parts that are subject to registration entered in the vehicle documents by your test centre.*

Art.-Nr. / Item No.: **STP.11.176.10001/B**

Revision: **01** · Datum / Date: **11 - 2021**

Sturzpadd-Kit für Vorderachse

Slider set for front axle

DEUTSCH - Vielen Dank, dass Sie sich für dieses Premium-Produkt von SW-MOTECH entschieden haben. Bitte besuchen Sie unseren Webshop für weitere Informationen wie Modellzuweisungen und PDF-Anbauanleitung. Erforderliche Dokumente (z. B. ABE) stehen als Download zur Verfügung.

Die Montage und/oder Wartung dieses Produkts erfordert ein gutes technisches Verständnis! Zu Ihrer eigenen Sicherheit empfiehlt SW-MOTECH, die Montage und/oder Wartung durch eine Fachwerkstatt durchführen zu lassen! SW-MOTECH übernimmt keine Haftung für Schäden, die durch eine unsachgemäße Montage und/oder Wartung verursacht wurden!

Beachten Sie alle in der Anbauanleitung angegebenen Hinweise und die für die Montage relevanten Informationen im Fahrzeughandbuch. Nichtbeachtung kann zu Schäden am Fahrzeug bzw. zur Gefährdung des Fahrers führen! Diese Anbauanleitung ist nach unserem derzeitigen Kenntnisstand verfasst worden. Rechtliche Ansprüche auf Richtigkeit bestehen nicht.

Dieses Produkt wurde für Fahrzeuge im Werkzustand entwickelt. Die Kompatibilität mit Original-Zubehörteilen bzw. den Zubehörteilen anderer Hersteller kann nicht gewährleistet werden. Stellen Sie des Weiteren VOR Montage dieses Produkts sicher, dass sich alle beweglichen Teile (z. B. die Kette) im ursprünglichen Wartungszustand befinden. Montiertes Zubehör kann das Fahrverhalten und/oder die Stabilität Ihres Fahrzeugs verändern.

ALLGEMEINE HINWEISE

Beachten Sie die landesspezifischen Vorschriften für Zulassung/Betrieb Ihres Fahrzeugs bzw. anwendbare TÜV-Vorschriften. Lassen Sie eintragungspflichtige Teile nach Montage durch Ihre Prüfstelle in die Fahrzeugpapiere eintragen.

VORBEREITUNG: Lesen Sie die Anbauanleitung aufmerksam und stellen Sie sicher, dass alle Teile der Stückliste vorhanden sind. Achten Sie darauf, dass Ihr Fahrzeug sicher steht und nicht umfallen kann. Schalten Sie den Motor ab und ziehen Sie den Zündschlüssel. Lassen Sie ggf. den Motor/Auspuff abkühlen. Klemmen Sie bei Arbeiten an der Elektrik die Fahrzeugbatterie ab. Verwenden Sie geeignetes Werkzeug. Lassen Sie sich von einer zweiten Person helfen.

MONTAGE: Alle vom Motorrad gelösten Teile und Verbindungen sind gemäß den Fahrzeugherstellereangaben wieder zu montieren oder durch die von SW-MOTECH gelieferten Teile zu ersetzen. Sichern Sie, falls nicht anderweitig definiert, alle Gewinde mit mittelfester, flüssiger Schraubensicherung.

Alle nicht durch SW-MOTECH definierten Anzugsmoment-Vorgaben müssen beim Fahrzeughersteller oder einer Fachwerkstatt erfragt werden!

FUNKTIONSKONTROLLE: Stellen Sie nach der Montage sicher, dass alle zuvor gelösten Teile und Verbindungen wieder ordnungsgemäß montiert wurden. Achten Sie außerdem auf die uneingeschränkte Freigängigkeit und einwandfreie Funktion sämtlicher Fahrzeugteile. Kabel, Züge und Schläuche dürfen nicht scheuern und/oder geklemmt werden. Führen Sie vor Fahrtbeginn eine umfassende Funktionskontrolle durch. Überprüfen Sie nach den ersten 50 km und anschließend in regelmäßigen Abständen das Anzugsmoment aller Schraubverbindungen und den ordnungsgemäßen Sitz des Produkts.

ENGLISH - Thank you for choosing this premium product from SW-MOTECH. Please visit our webshop for additional information, such as application charts and PDF mounting instructions. Any other documents that may be required (e.g. ABE certifications), are also available for download at our webshop.

Installation and/or maintenance of this product require good technical understanding! For your own safety SW-MOTECH recommends having installation and/or servicing carried out by a specialist workshop! SW-MOTECH assumes no liability for damage caused by improper installation and/or maintenance work!

Carefully follow all the directions given in the mounting instructions and pay attention to all relevant information in the vehicle manual during assembly. Nonconformance can lead to vehicle damage or even endanger the driver! These mounting instructions are written based on our current state of knowledge. Legal requirements for accuracy do not exist.

This product was developed for vehicles in their factory setting. Compatibility with original accessory parts or other manufacturers' accessory parts is not guaranteed. Furthermore, BEFORE installing this product, make sure that all moving parts (e.g. the chain) are in the original state of maintenance. Installed accessories can change the driving behaviour and/or stability of your vehicle.

GENERAL INFORMATION

Observe the country-specific regulations concerning vehicle registration/operation as well as TÜV regulations if applicable. If required, register installed parts in the vehicle documents through an appropriate inspection authority.

PREPARATION: Read the mounting instructions carefully and make sure that all items of the parts list are included. Make sure that your vehicle is parked safely and cannot fall over. Turn off the engine and remove the ignition key. Let the motor/exhaust cool off if necessary. Disconnect the vehicle battery when working on the electrical system. Use appropriate tools. Have another person to help you.

MOUNTING: All parts and connections removed from the vehicle must be reinstalled in accordance with the vehicle manufacturers' specifications or replaced by parts delivered by SW-MOTECH. Secure all threads, unless otherwise specified, with medium-strength liquid thread locker.

Torque specifications undefined by SW-MOTECH must be obtained from the vehicle manufacturer or by a specialist workshop!

FUNCTION CHECK: After installation make sure that all parts and connections previously removed are properly replaced. Also make sure that no moving parts are obstructed and no function of the vehicle is hindered in any way. Cables and hoses must not rub and/or be pinched. Before starting to ride, perform a comprehensive check of all functions. After the first 50 km and then at regular intervals, check the tightening torque of all screw connections and the proper fit of the product.

Konfektionierung durch / Packed by:

Datum der Konfektionierung / Date of packaging:



SW-MOTECH GmbH & Co. KG
Ernteweg 7-10
35282 Rauschenberg
Germany

Tel. / phone + 49 (0)6425 / 8168 - 050
Fax / fax + 49 (0)6425 / 8168 - 10
info@sw-motech.com
www.sw-motech.com

STÜCKLISTE / PARTS LIST

Schritt Step	Nr. No.	Art.-Nr. / Bezeichnung ^a Item No. / Description ^a	Artikel	Part	Anzahl ^b Quantity ^b	N·m ^c
1	(1)	GST.ST.08.325	Gewindestange; Länge 325 mm	Threaded Rod; length 325 mm	1 / 1	
	(2)	STP.00.176.012	Buchse, gestuft; links; Höhe 28 mm	Spacer, stepped; left; height 28 mm	1 / 1	
	(3)	STP.00.176.013	Buchse; rechts; Höhe 16 mm	Spacer; right; height 16 mm	1 / 1	
	(4)	M8; DIN 439	Mutter, niedrige Form	Nut, low form	2 / 2	18
2	(5)	STP.00.176.004	Sturzpad	Slider	2 / 2	
	(6)	Ø 19 / Ø 15,2 / h 4,4	Auflagebuchse; schwarz	Support Spacer; black	2 / 2	
	(7)	Ø 8,4; DIN 9021	Unterlegscheibe; schwarz	Washer; black	2 / 2	
	(8)	M8; DIN 985	Mutter, selbstsichernd	Lock Nut	2 / 2	18
3	(9)	STP.00.176.005 / ...006	Abdeckkappe mit Feder	Cover Cap with Spring	2 / 2	

	Regelgewinde / Coarse Thread Ø	M4	M5	M6	M8	M10	M12		Regelgewinde / Coarse Thread Ø	M4	M5	M6	M8	M10	M12		
8.8	Stahl FK 8.8 / Steel CL 8.8	N·m	2,8	5,5	9,6	23	46	79	10.9	Stahl FK 10.9 / Steel CL 10.9	N·m	4,1	8,1	14	34	67	115

Anmerkungen: ^a Alle Maßangaben in Millimeter. ^b Der zweite Wert gibt die Gesamtanzahl des jew. Artikels in der Lieferung an. ^c **Keine Anzugsmomentvorgabe: Verwenden Sie das vom Fzg.-Hersteller definierte Anzugsmoment!** Das Std.-Anzugsmoment der Tabelle kann verwendet werden, wenn es den Fzg.-Hersteller-Vorgaben entspricht.

Note: ^a All measurements in millimeters. ^b The second number indicates the total quantity of the part in the delivery. ^c **No torque specifications: Use the torque defined by vehicle manufacturer!** The standard torque in this table can be used as long as it is within the vehicle manufacturer's specifications.

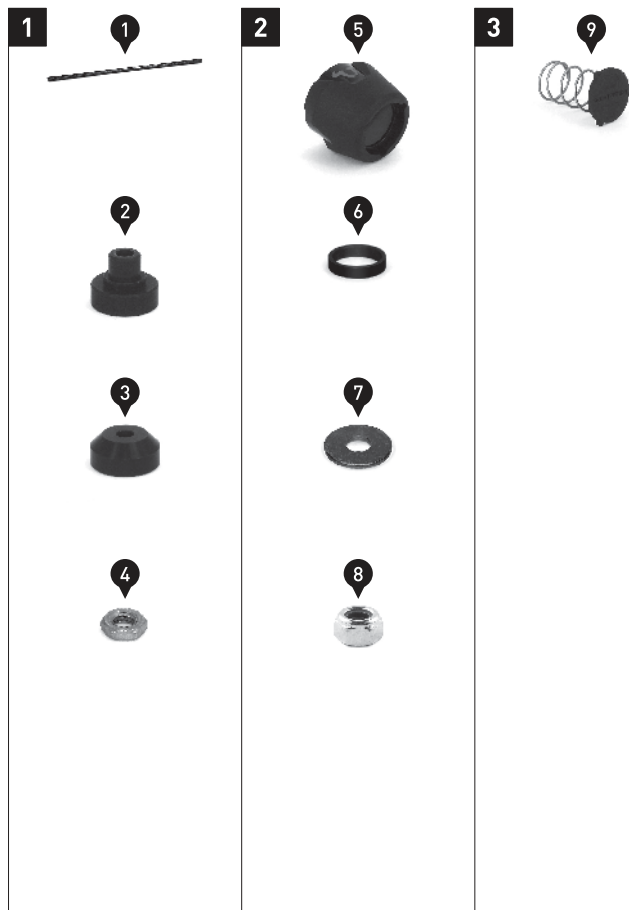

MONTAGE / MOUNTING

1

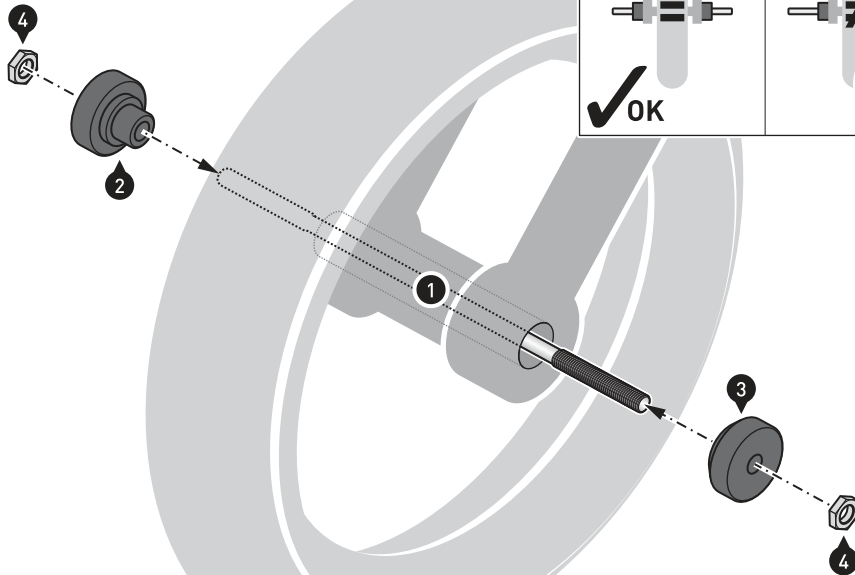
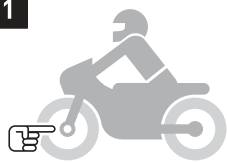

Führen Sie die Gewindestange (1) durch die **vordere** Achsaufnahme Ihres Fahrzeugs.

Stecken Sie nun die Buchsen (2) und (3) auf die Gewindestange (1) auf, wie in der Zeichnung gezeigt.

ACHTUNG: Achten Sie auf die zentrierte Ausrichtung der Gewindestange (1)!

Montieren Sie anschließend die gezeigten Komponenten mit den Muttern (4) am Fahrzeug.

ACHTUNG: Verwenden Sie flüssige Schraubensicherung!

Ziehen Sie die Muttern (4) wie vorgegeben an.

Guide the threaded rod (1) through the **front** axle mount of your vehicle.

Then plug the spacers (2) and (3) onto the threaded rod (1), as shown in the drawing.

ATTENTION: Pay attention to the centered alignment of the threaded rod (1)!

Then mount the shown components with the nuts (4) to the vehicle.

ATTENTION: Use liquid thread locker!

Tighten the nuts (4) as specified.



18 N·m



Medium

Das Fahrzeug dient als Beispiel. / Example vehicle shown.

2

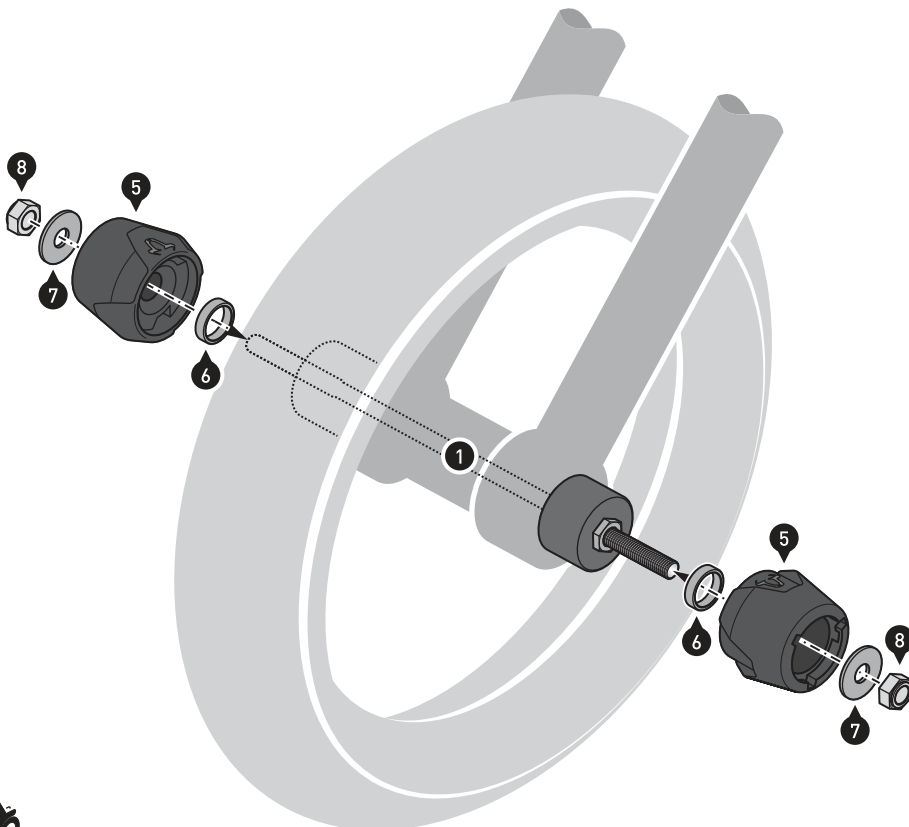

Montieren Sie die Sturz pads (5) mit den Muttern (8) **beidseitig** an der Gewindestange (1).

Ziehen Sie die Muttern (8) wie vorgegeben an.

Mount the sliders (5) with the nuts (8) on **both sides** to the threaded rod (1).

Tighten the nuts (8) as specified.



18 N·m



Das Fahrzeug und die montierten Buchsen dienen als Beispiele. / The vehicle and the mounted spacers are examples.

3

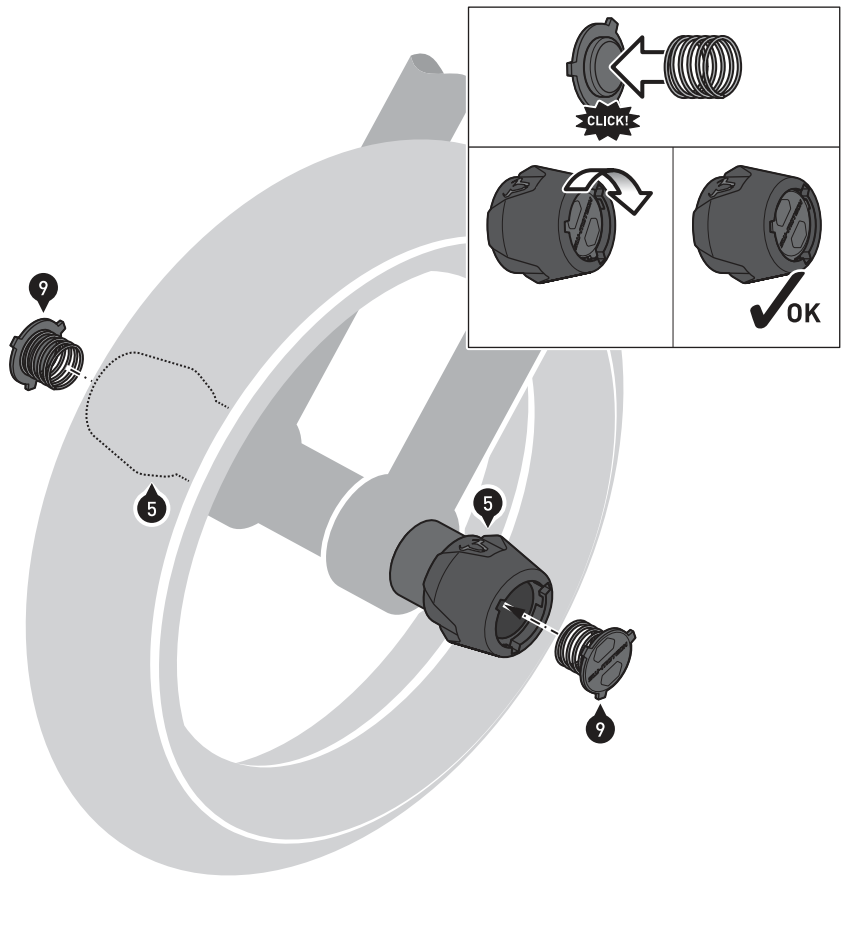

Setzen Sie **beidseitig** die Abdeckkappen (9) in die Öffnungen der montierten Sturz pads (5) ein und drehen Sie diese bis in die Endposition.
ACHTUNG: Achten Sie auf den festen Sitz der Abdeckkappen (9).

Insert the cover caps (9) on **both sides** into the openings of the mounted sliders (5) and turn them to their end position.
ATTENTION: Make sure that the cover caps (9) fit firmly.



Das Fahrzeug und die montierten Buchsen dienen als Beispiele. / The vehicle and the mounted spacers are examples.