

Scan QR Code to Watch Installation Video

Thank you for purchasing a National Cycle product. Read these instructions carefully and thoroughly before beginning work. Dealers, if installing this product for a customer, please give them this manual upon completion. It contains information needed to properly maintain and use this product.

Description:	Adventure Side Guards	Model:	2019-Current Honda® CB500X
Part Number:	P4200	Installation Time:	30-45 min.

#### P4900 PARTS LIST

ITEM	PART NO.	DESCRIPTION	QUANTITY
A	90-970541-000	Adventure Side Guard, Right, Black	1
B	90-970540-000	Adventure Side Guard, Left, Black	1
<b>BAG#1346</b>			
C	50-571200-000	Cap Screw, Hex, Flanged, M10-1.25 x 25	1
D	49-490460-000	Washer, Flat, M10 x 20 x 2M	1
E	42-421000-000	Nylock Hex Nut, M10-1.25, Zinc	1

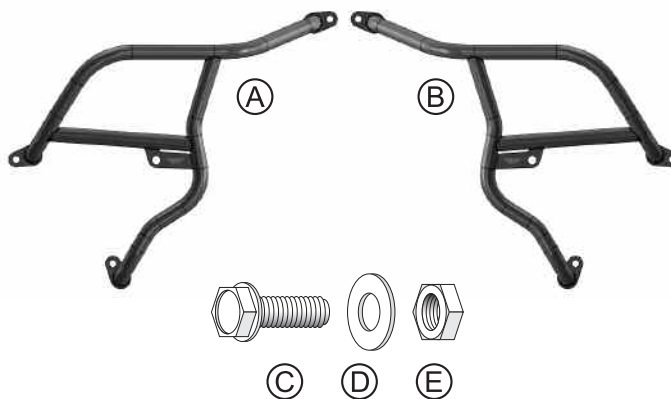

#### TOOLS REQUIRED FOR ASSEMBLY

17mm Box Wrench	Ratchet with 6" Extension
14mm Socket	Torque Wrench



**ATTENTION:** Special notes and cautionary measures which can prevent damage to the accessory or vehicle.



**NOTE:** Tips for facilitation of operation, control and adjustment, as well as maintenance work.

#### PREPARATION

Carefully unpack your new accessory, sort the parts, and make sure you have everything required to complete the assembly.

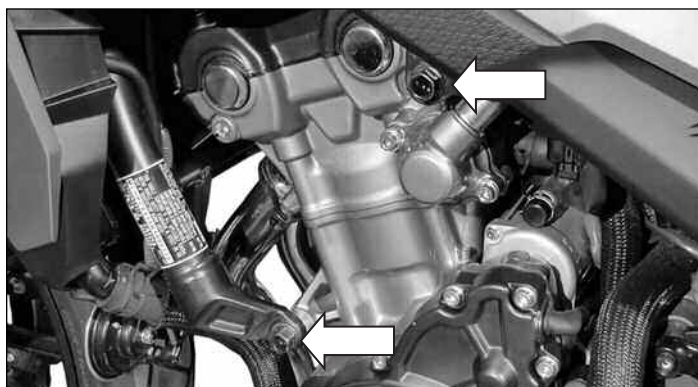

Figure 1

#### INSTALLATION STEP 1: REMOVE LEFT SIDE OEM MOTOR MOUNTS

##### Figure 1

Before the P4200 Adventure Side Guards can be installed, the OEM motor mount bolts and spacers (indicated) must be removed.



**NOTE:** Begin work on the left side, and continue to the right side only when the left side is complete.



Figure 2



Figure 3



Figure 4

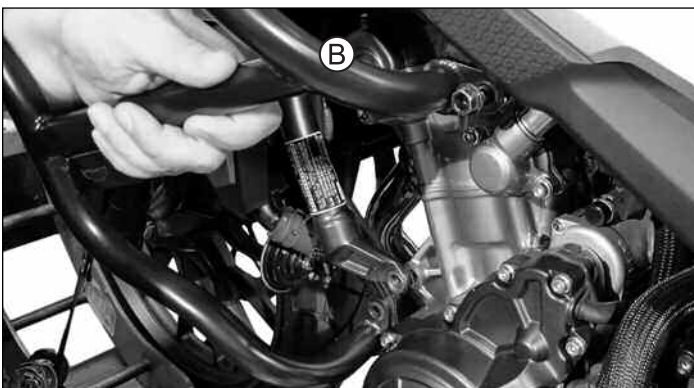

Figure 6

## INSTALLATION STEP 1: REMOVE LEFT SIDE OEM MOTOR MOUNTS; CONT'D

### Figures 2-3

Using a 14mm Socket, 6-Inch Extension and Ratchet, remove the top left-side 10x75 motor mount bolt and set it aside for reinstallation.

Remove the OEM 45.5mm collar between the motor and the motor mount frame member and set it aside for reinstallation.

### Figures 4-5

Using a 14mm Socket, remove the bottom left-side 10x40 motor mount bolt and set it aside for reinstallation.

Remove the OEM 8mm collar between the motor and the motor mount frame member and set it aside for reinstallation.

## INSTALLATION STEP 2: INSTALL LEFT ADVENTURE SIDE GUARD

### Figures 6-7

Place the Left Side Guard (B) into approximate position. Reinsert the OEM 45.5mm collar between the motor and top motor mount, insert the OEM top motor mount bolt through the left Side Guard, and then tighten with a 14mm Socket.

 **NOTE: Do not tighten to final torque settings at this point. Just make it a snug fit.**



Figure 5



Figure 7



Figure 8

**INSTALLATION STEP 2; CONT'D:  
INSTALL LEFT ADVENTURE SIDE GUARD**

**Figures 8-9**

Reinsert the OEM 8mm collar between the motor and bottom motor mount, insert the OEM bottom motor mount bolt through the left Side Guard, and thread until it bottoms.

 **NOTE: Do not tighten to final torque setting at this point. Just make it a snug fit.**

**INSTALLATION STEP 3:  
INSTALL RIGHT ADVENTURE SIDE GUARD**

 **NOTE: Repeat the steps from Figures 1-9 on the right side of the motorcycle with the Right Adventure Side Guard (A).**



Figure 9

**INSTALLATION STEP 4:  
JOIN FRONT HALVES OF LEFT/RIGHT SIDE GUARDS**

**Figures 10-13**

Join the two halves of the P4200 Side Guards with the Flanged Hex Cap Screw (C), Flat Washer (D) and Nylock Hex Nut (E).

 **NOTE: Fasten the hardware just finger-tight for now. Final tightening will come later.**



Figure 10

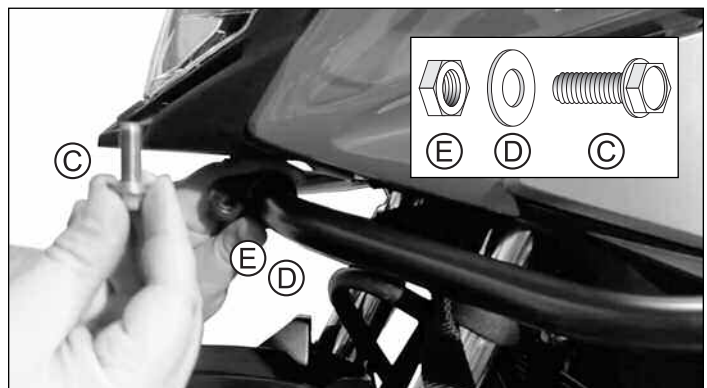

Figure 11



Figure 12



Figure 13

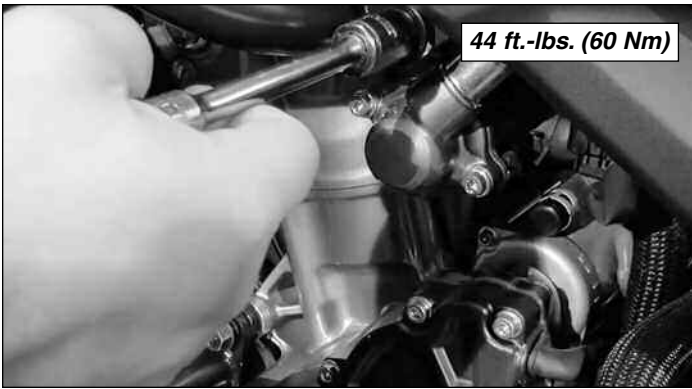

Figure 14

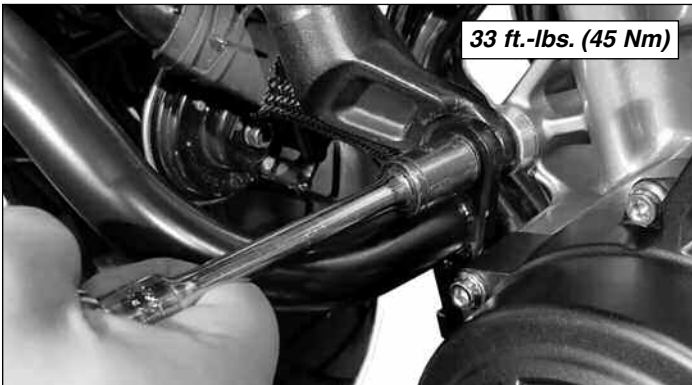

Figure 15



Figure 16

## INSTALLATION STEP 5: TIGHTEN LEFT/RIGHT SIDE MOTOR MOUNTS

### Figures 14-15

Tighten the top and bottom motor mount bolts on left and right sides of motorcycle to factory torque specs.



**ATTENTION: Factory torque specifications are:**  
**44 ft.-lbs. (60 Nm) for the top 10x75 motor mount bolts**  
**33 ft.-lbs. (45 Nm) for the bottom 10x40 motor mount bolts**

### Figures 16

Using a 17mm Box Wrench and 14mm Socket, securely tighten the front hardware of the Left/Right Adventure Side Guards.

### Figures 17

The installation is now complete.

**Test ride for function and performance, and enjoy your new P4200 Adventure Side Guards!**



Figure 17

## **WARNING**

Never operate your vehicle with loose accessory mounting hardware. Check the hardware for tightness regularly.

Motorcycles are built with enough frame rigidity to withstand the moderate loads imposed on them by the foreseeable addition of an accessory(ies). If an accessory(ies) adversely affects your vehicle's stability, immediately remove the accessory(ies). Do not operate a vehicle that exhibits unsafe handling traits.

Have experienced service personnel correct any problem before driving with the accessory(ies) installed. For further questions concerning handling problems associated with an accessory(ies), contact your dealer, motorcycle manufacturer, or accessory manufacturer.

