

TMT9056 - TMT9056K

TELAIETTO LATERALE SPECIFICO - SPECIFIC SADDLEBAG TUBULAR HOLDER - SUPPORT TUBULAIRE POUR SACOCHES CAVALIÈRES - SPEZIAL SEITENTRAEGER FUER WEICHTASCHEN - PORTA ALFORJAS TUBULAR LATERAL - SUPORTE LATERAL DE ALFORGES

ROYAL ENFIELD HNTR 350 (2022)

N°	Descrizione/Description	Caratteristiche/Features	Codice/Code	Quantità/Quantity
1	Supporto laterale - Lower frame - Support latéral - Soporte lateral Untere Halterung - Suporte lateral	-	TMT9056DXV TMT9056SXV	2(Right,Left)
2	Vite - Screw - Vis - Schraube Tornillo - Parafuso	TCES M10x60	1060TCES	2
3	Vite - Screw - Vis - Schraube Tornillo - Parafuso	TBEI M8x25	825TBEI	1
4	Vite - Screw - Vis - Schraube Tornillo - Parafuso	TBEI M8x80	880TBEI	2
5	Rondella - Washer Rondelle - Scheibe Arandela - Arruela	Foro Ø10mm	10RON	4
6	Rondella - Washer Rondelle - Scheibe Arandela - Arruela	Foro Ø8mm / Esterno Ø20mm / Sp. 2mm	820RON	6
7	Distanziale - Spacer Entretoise - Distanzstueck Distanciador - Espaçador	Ø18x32 Foro 8,5mm	C18L32F8,5T	2
8	Dado - Bolt - Ecrou Mutter - Tuerca - Porca	Dado Autobloccante Flangiato Alto M8 (9,5mm)	8DADIFN	3
9	Tappo - Cap Fiche - Stecker Enchufe - Capa	-	13COP	1
10	Componenti Originali - Original Parts Parties Originales - Original Bauteile Componentes Originales - Componentes Originais	-	-	-
11	Particolari Inclusi nel SR9056 Components Included In The SR9056 Pièces Inclues Dans SR9056 Die Einzelnen Teile Sind Bei SR9056 Despieces Incluidos SR9056 Componentes incluidos na SR9056	-	-	-

IT_ Nel caso in cui sulle viti originali sia presente del frenafilletti, ripristinarlo durante il montaggio dell'accessorio.

EN_ If there is threadlocker on the original screws, use threadlocker when mounting the accessory.

DE_ Falls sich auf den Originalschrauben Schraubensicherungsklebstoff befand, sollte dieser auch bei der Montage des Zubehörs wieder aufgetragen werden

FR_ Si du frein filet est présent sur les vis d'origine, l'appliquer également lors du montage de l'accessoire

ES_ En caso de que el fijador de roscas se encuentre presente en los tornillos originales, colocarlo nuevamente en el montaje del accesorio

PT_ Se houver trava rosca nos parafusos originais, inserir novamente durante a montagem do acessório

TMT9056 - TMT9056K

TELAIETTO LATERALE SPECIFICO - SPECIFIC SADDLEBAG TUBULAR HOLDER - SUPPORT TUBULAIRE POUR SACOCHES CAVALIÈRES - SPEZIAL SEITENTRAEGER FUER WEICHTASCHEN - PORTA ALFORJAS TUBULAR LATERAL - SUPORTE LATERAL DE ALFORGES

ROYAL ENFIELD HNTR 350 (2022)

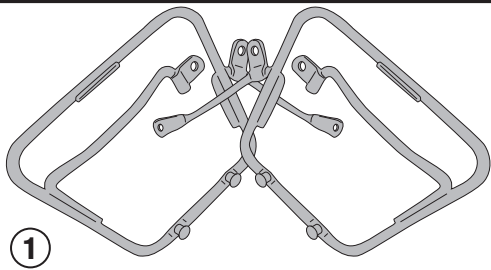

TMT9056DXV/TMT9056SXV

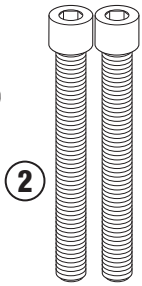

M10x60mm

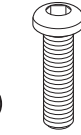

M8x25mm

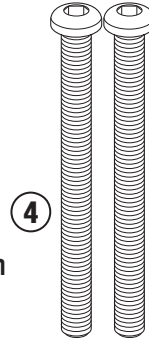

M8x80mm



Hole Ø10mm

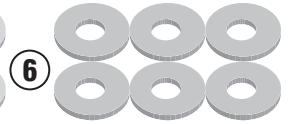

Hole Ø8mm
External Ø20mm
D.2mm

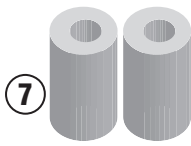

Hole Ø8,5mm
External Ø18mm
H.32mm

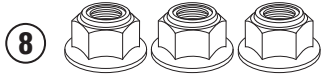

M8

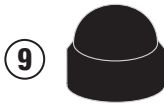

13COP

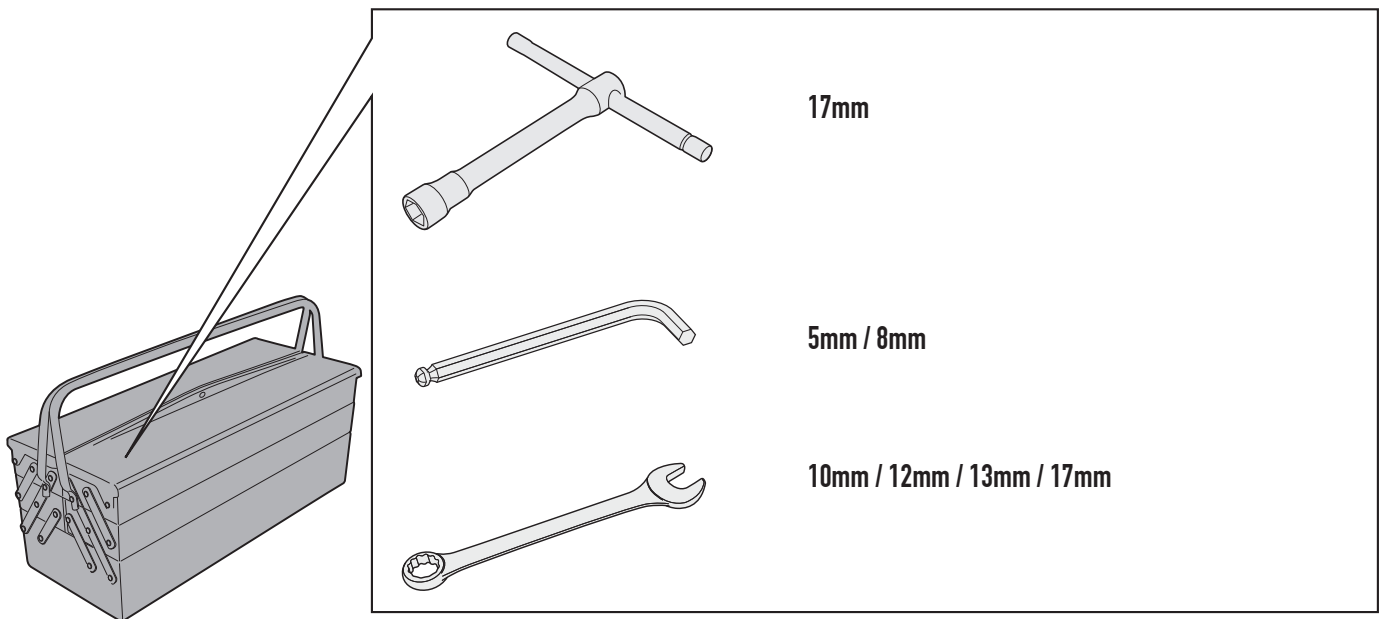

TMT9056 - TMT9056K

TELAIETTO LATERALE SPECIFICO - SPECIFIC SADDLEBAG TUBULAR HOLDER - SUPPORT TUBULAIRE POUR SACOCHES CAVALIÈRES - SPEZIAL SEITENTRÄGER FUER WEICHTASCHEN - PORTA ALFORJAS TUBULAR LATERAL - SUPORTE LATERAL DE ALFORGES

ROYAL ENFIELD HNTR 350 (2022)

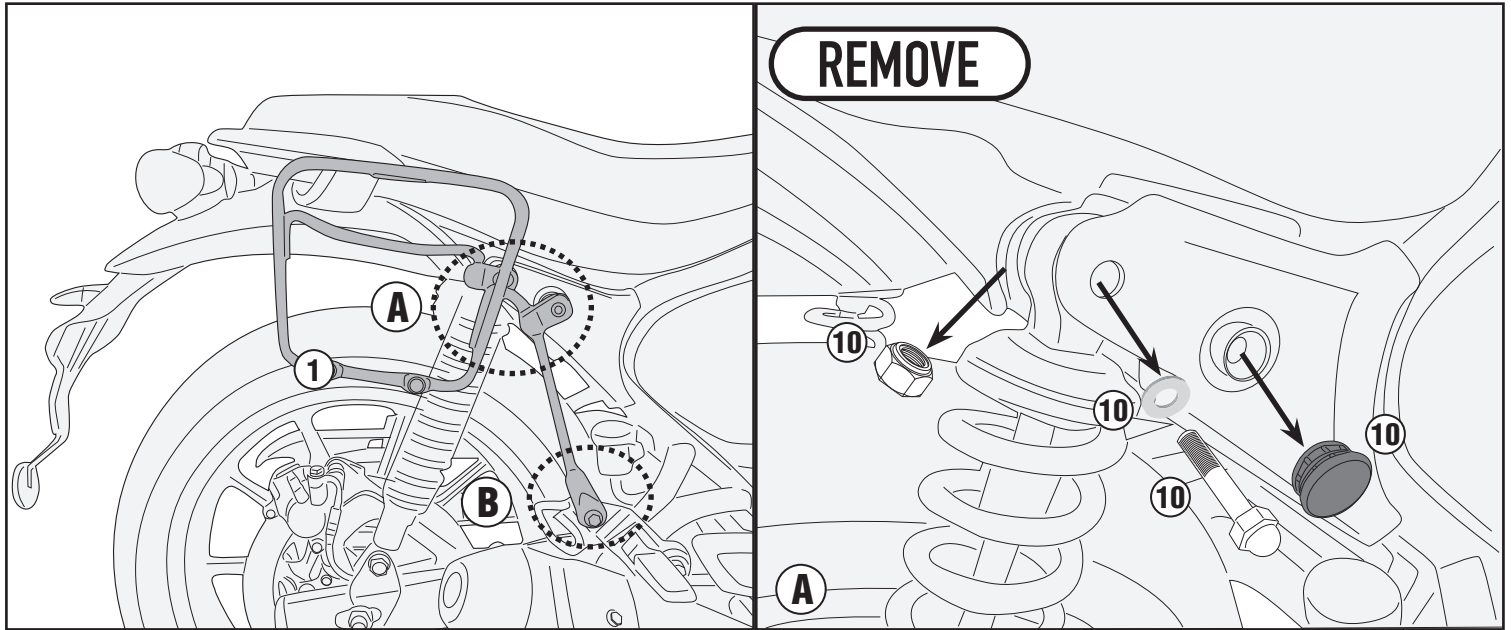

SR9056+TMT9056

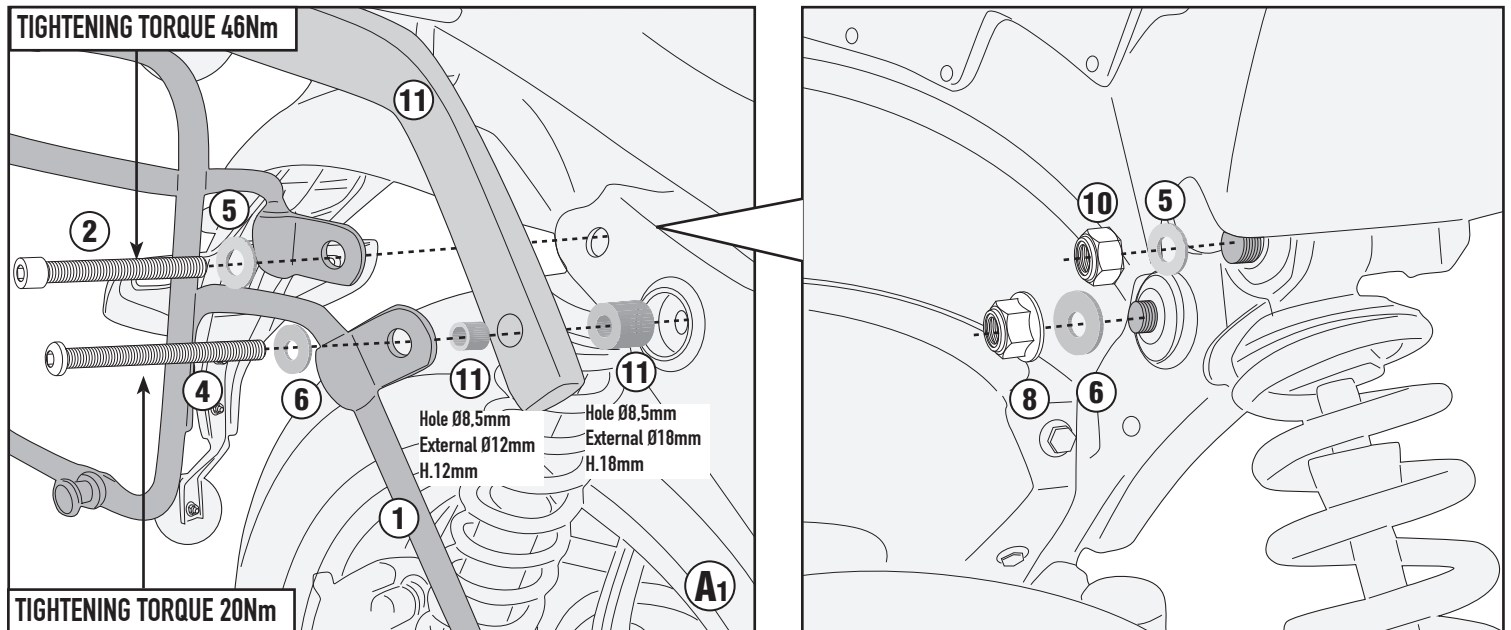

TMT9056 - TMT9056K

TELAIETTO LATERALE SPECIFICO - SPECIFIC SADDLEBAG TUBULAR HOLDER - SUPPORT TUBULAIRE POUR SACOCHES CAVALIÈRES - SPEZIAL SEITENTRAEGER FUER WEICHTASCHEN - PORTA ALFORJAS TUBULAR LATERAL - SUPORTE LATERAL DE ALFORGES

ROYAL ENFIELD HNTR 350 (2022)

ONLY TMT9056

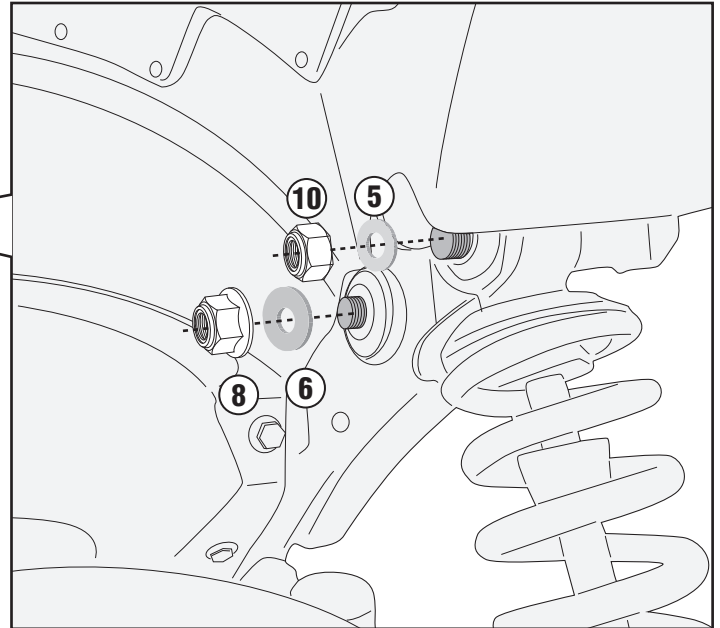
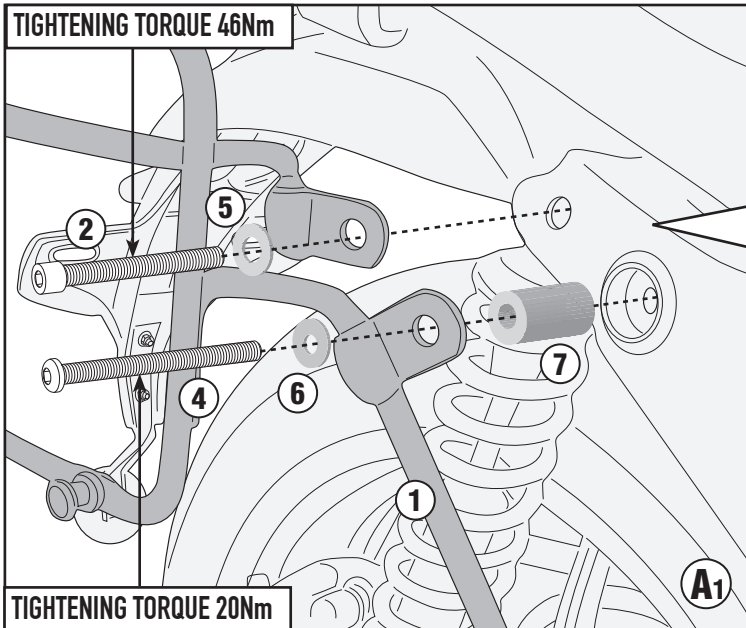

SR9056+TMT9056

ONLY TMT9056

RIGHT SIDE

LEFT SIDE

