

BF76 – BF76K

Flangia Specifica per borse Tanklock – Specific Carrier for Tanklock bags
Brides spécifiques pour Tanklock bagagerie souple – Tankringen für tanklock Weichtaschen
Aro específico para bolsa Tanklock – Anel específico para bolsa Tanklock

N°	Descrizione-Description	Caratteristiche-Features	Codice-Code	Quantità-Quantity
1	Supporto anteriore – Front support Support avant – Vordere Unterstützung Soporte frontal – Suporte frontal	-	GL5406V	1
2	Supporto posteriore – Rear support Hintere Unterstützung – Support arrière Soporte trasero – Suporte traseiro	-	GL5407V	1
3	Supporto superiore – Support higher Support supérieur – Halterung höher Soporte superior – Apoio superior	-	GL5408V	1
4	Piastra interna – Inner plate Plaque interne – Placa interna Innere Platte – Placa interna	-	GL5409SZ	1
5	Vite – Screw Vis – Schraube Tornillo – Parafuso	TBEI M5x16	516TBEI	4
6	Dado – Bolt Ecrou – Mutter Tuerca – Porca	Dado Autobloccante Flangiato M5	5DADIAFL	4
7	Tappo – Cap Fiche – Stecker Enchufe – Capa	-	ZTPD5	4
8	Protezione Adesiva – Adhesive Protection Protection Adhesive – Schutzkleber Protección Adhesiva – Proteção Adesiva	-	Z2388	1
9	Protezione Adesiva – Adhesive Protection Protection Adhesive – Schutzkleber Protección Adhesiva – Proteção Adesiva	-	Z2518	3
10	Componenti Originali – Original Parts Parties Originales – Original Bauteile Componentes Originales – Componentes Originais	-	-	-
11	Particolari inclusi nella borsa tanklock Components included in the tanklock bag Pièces incluses dans la tanklock bag Teile inkludiert in der tanklock tasche Componente incluido na bolsa tanklock	-	-	-

IT_ Nel caso in cui sulle viti originali sia presente del frenafili, ripristinarlo durante il montaggio dell'accessorio.

EN_ If there is threadlocker on the original screws, use threadlocker when mounting the accessory.

DE_ Falls sich auf den Originalschrauben Schraubensicherungsstoff befand, sollte dieser auch bei der Montage des Zubehörs wieder aufgetragen werden

FR_ Si du frein filet est présent sur les vis d'origine, l'appliquer également lors du montage de l'accessoire

ES_ En caso de que el fijador de roscas se encuentre presente en los tornillos originales, colocarlo nuevamente en el montaje del accesorio

PT_ Se houver trava rosca nos parafusos originais, inserir novamente durante a montagem do acessório

BF76 - BF76K

Flangia Specifica per borse Tanklock - Specific Carrier for Tanklock bags
Brides spécifiques pour Tanklock bagagerie souple - Tankringen für tanklock Weichtaschen
Aro específico para bolsa Tanklock - Anel específico para bolsa Tanklock

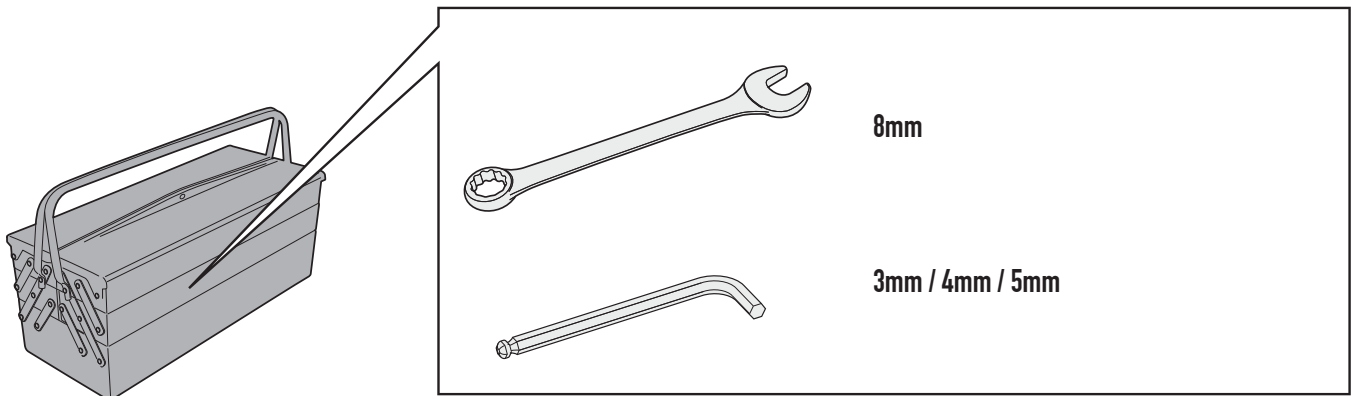
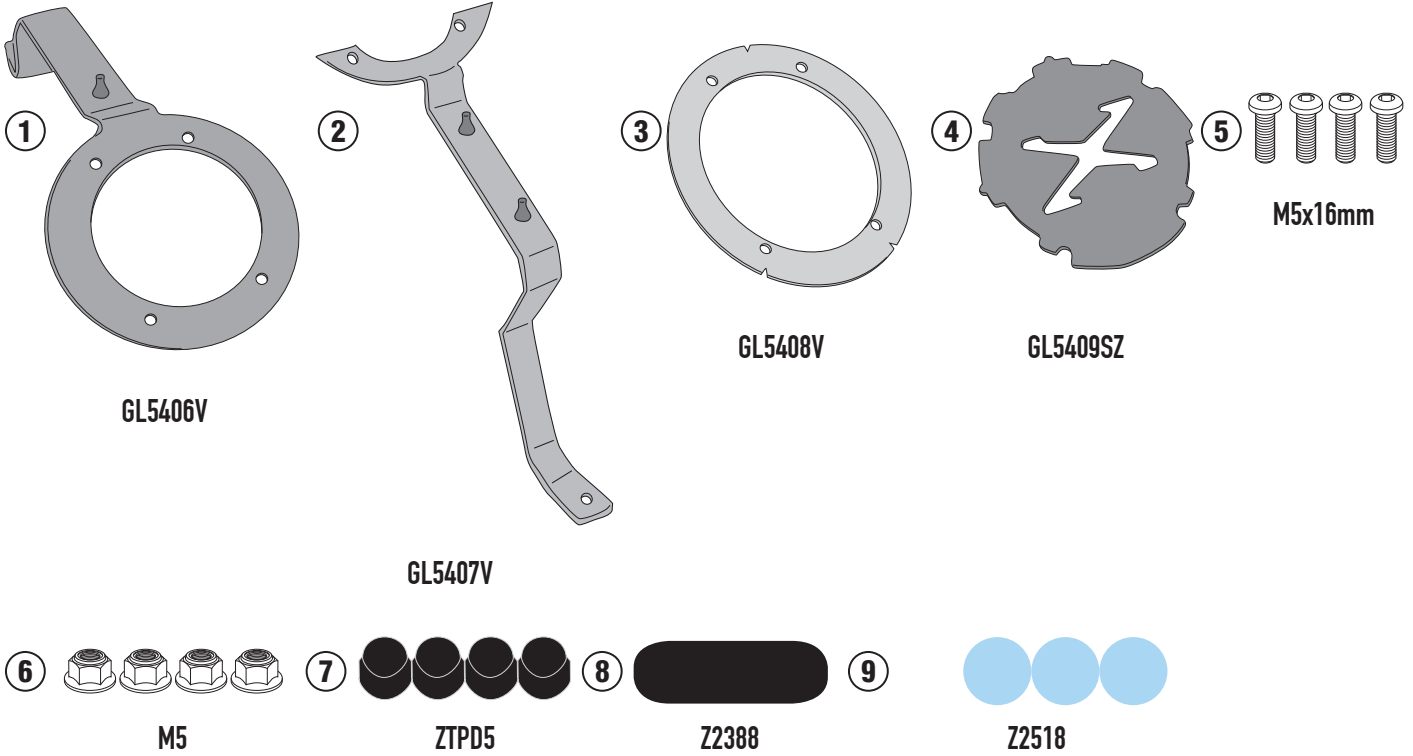

BF76 - BF76K

Flangia Specifica per borse Tanklock - Specific Carrier for Tanklock bags
Brides spécifiques pour Tanklock bagagerie souple - Tankringen für tanklock Weichtaschen
Aro específico para bolsa Tanklock - Anel específico para bolsa Tanklock

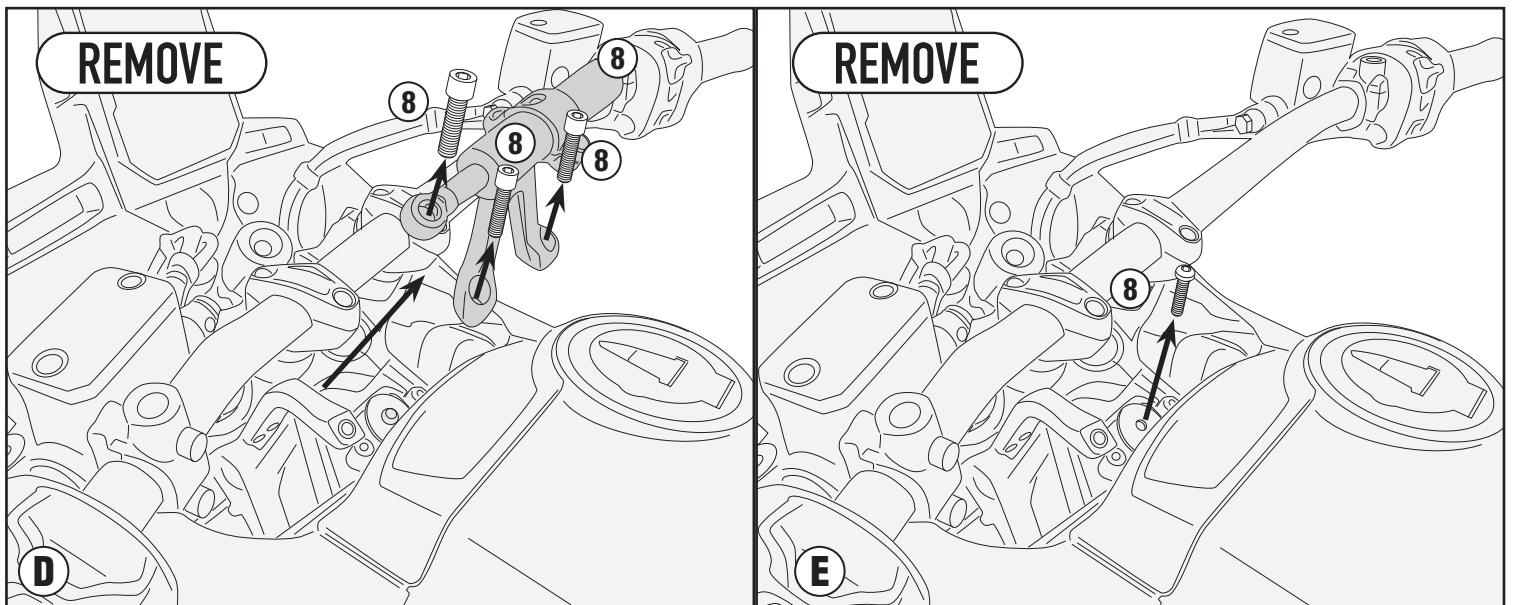
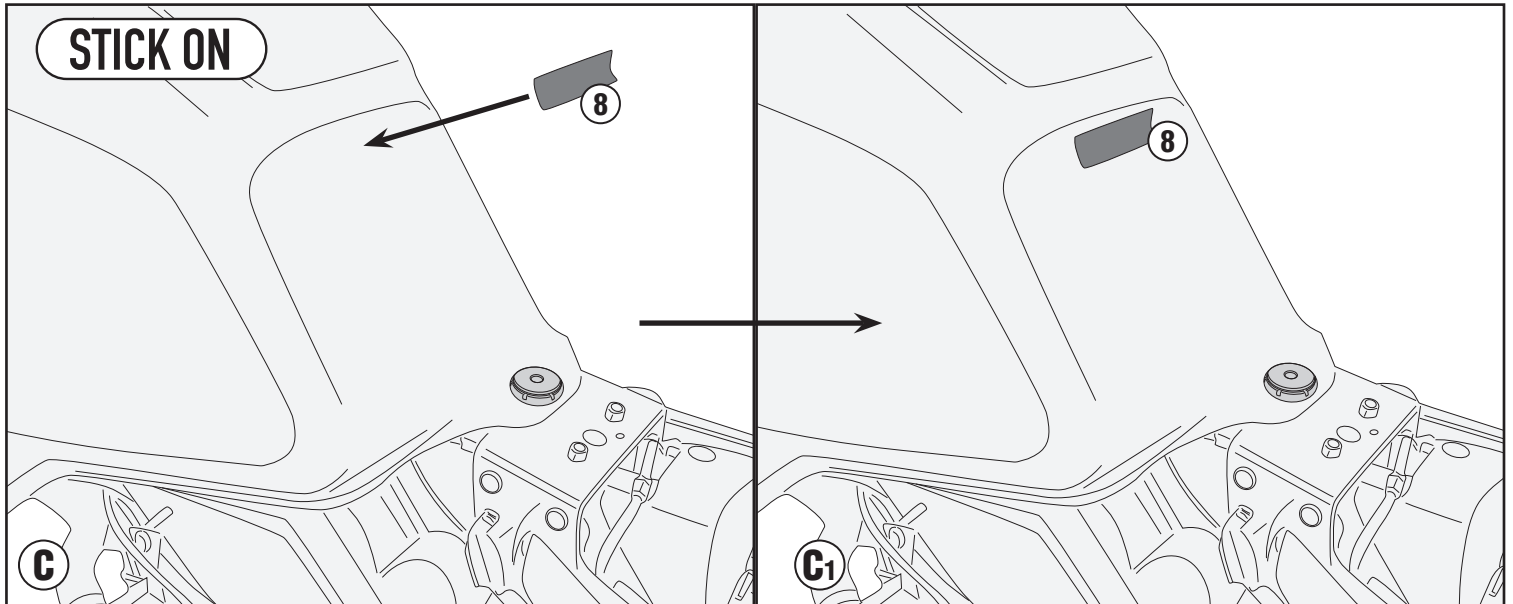
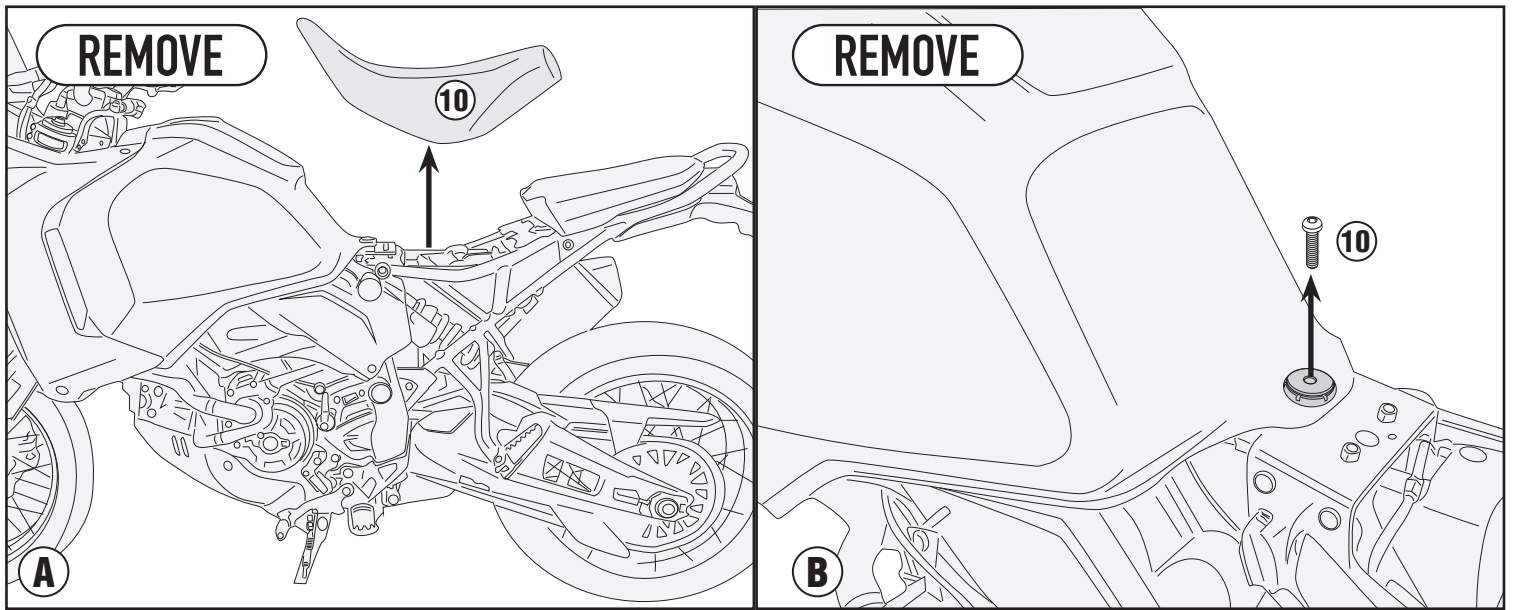

BF76 - BF76K

Flangia Specifica per borse Tanklock - Specific Carrier for Tanklock bags
Brides spécifiques pour Tanklock bagagerie souple - Tankringen für tanklock Weichtaschen
Aro específico para bolsa Tanklock - Anel específico para bolsa Tanklock

TIGHTENING TORQUE 5,5Nm

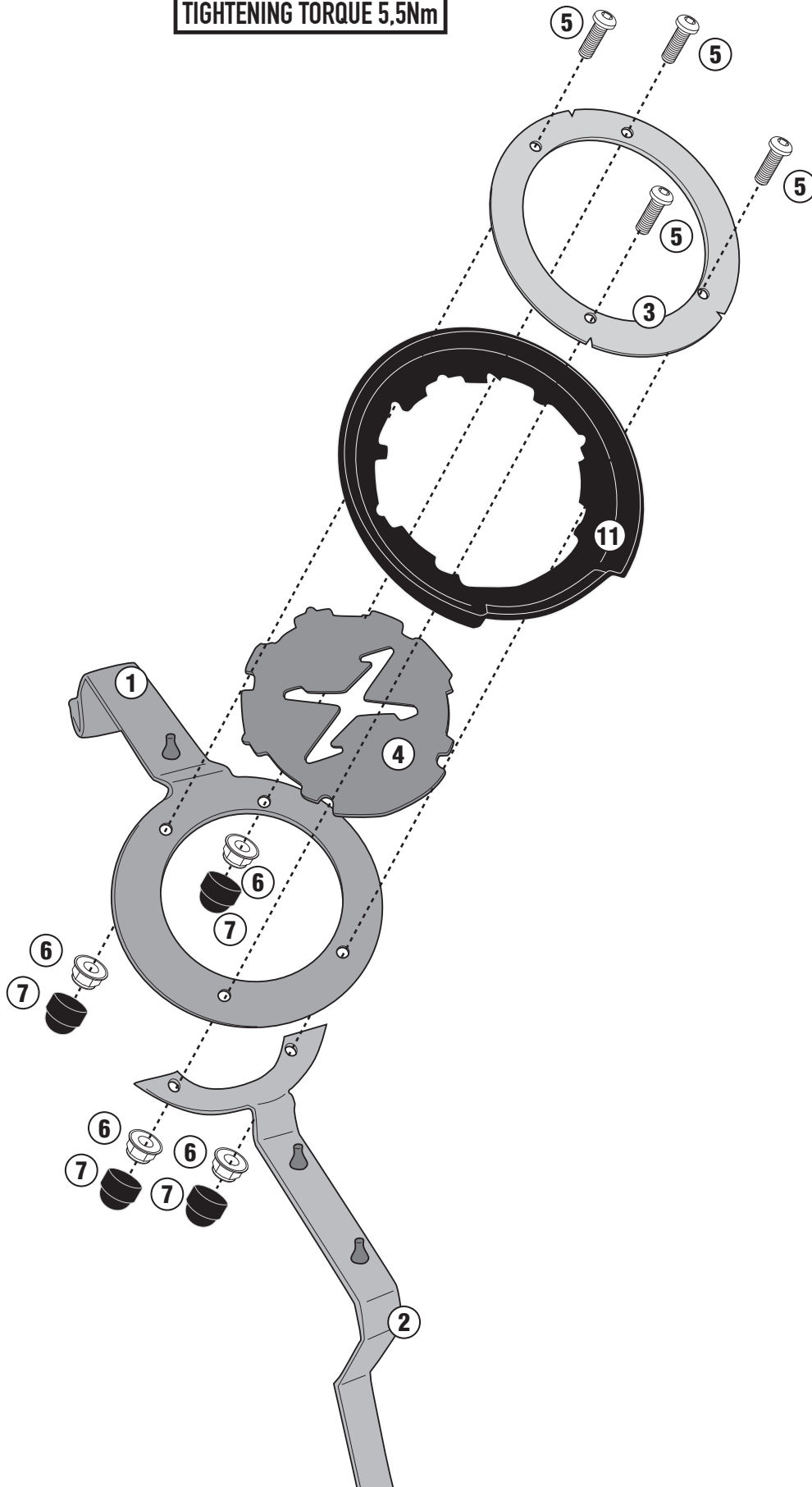

F

BF76 - BF76K

Flangia Specifica per borse Tanklock - Specific Carrier for Tanklock bags
Brides spécifiques pour Tanklock bagagerie souple - Tankringen für tanklock Weichtaschen
Aro específico para bolsa Tanklock - Anel específico para bolsa Tanklock

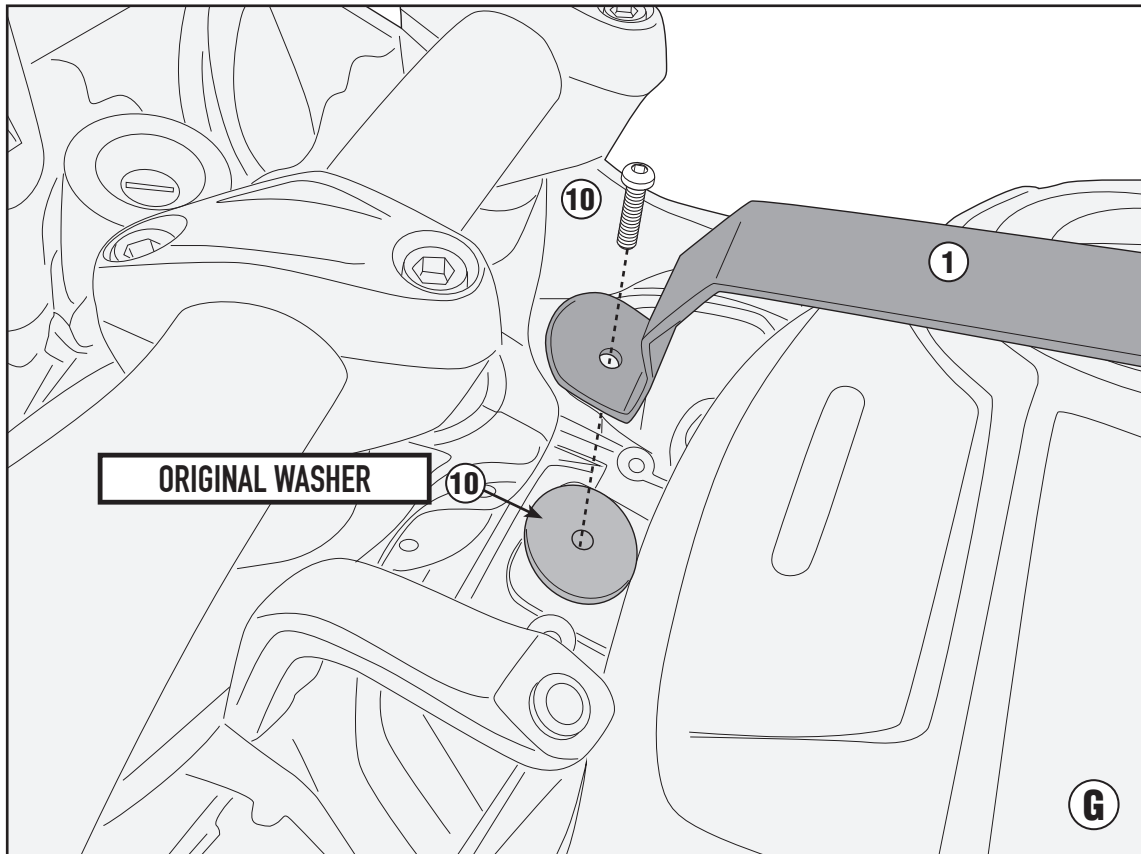
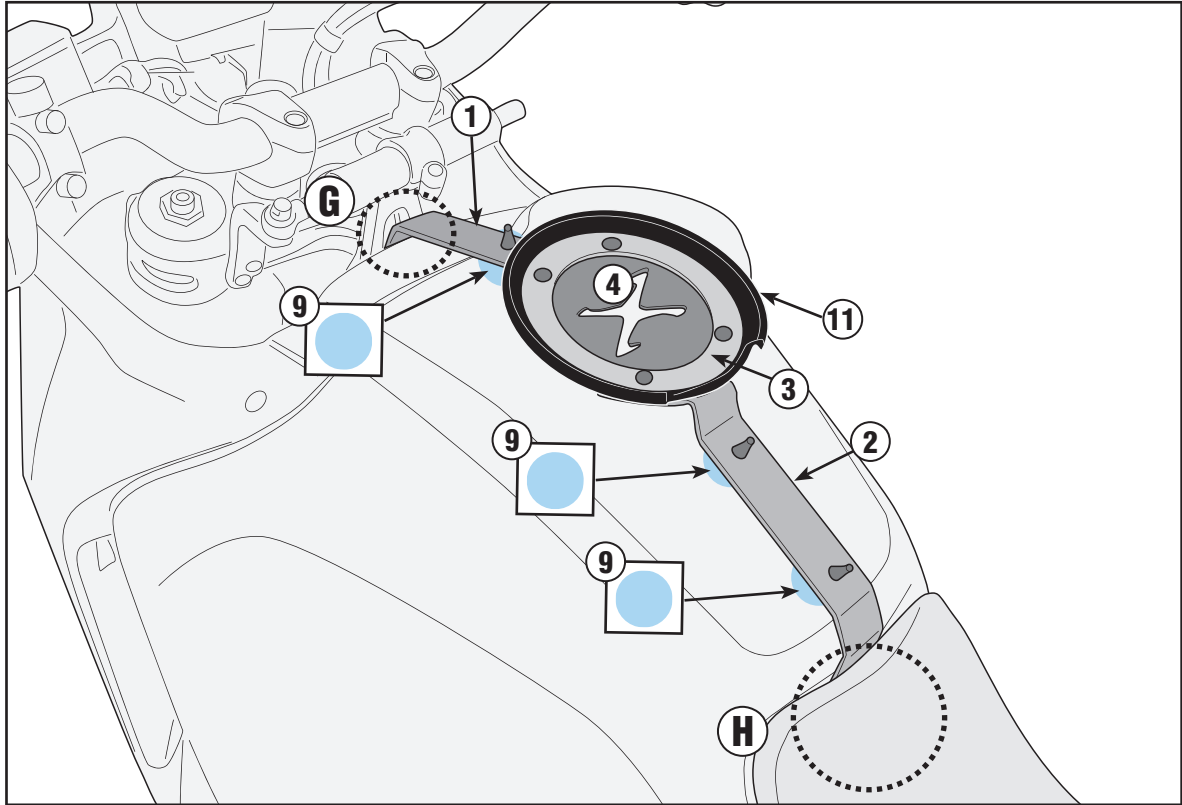

BF76 - BF76K

Flangia Specifica per borse Tanklock - Specific Carrier for Tanklock bags
Brides spécifiques pour Tanklock bagagerie souple - Tankringen für tanklock Weichtaschen
Aro específico para bolsa Tanklock - Anel específico para bolsa Tanklock

