



EVOTECH®
P E R F O R M A N C E

www.evotech-performance.com

Yamaha MT-10
Tail Tidy Instruction



- Ⓐ 1 x Grommet
- Ⓑ 1 x Retro light
- Ⓒ 1 x Con 10
- Ⓓ 2 x M4 Nyloc
- Ⓔ 2 x P-clip Type 2
- Ⓕ 2 x M4 x 5mm Black Button Head Bolt
- Ⓖ 2 x M5 x 12mm Black Button Head Bolt
- Ⓗ 2 x M4 x 8mm Black Button Head Bolt
- Ⓘ 2 x M6 x 20mm Black Button Head Bolt
- Ⓙ 2 x M6 x 25mm Black Caphead Bolt

P E R F O R M A N C E

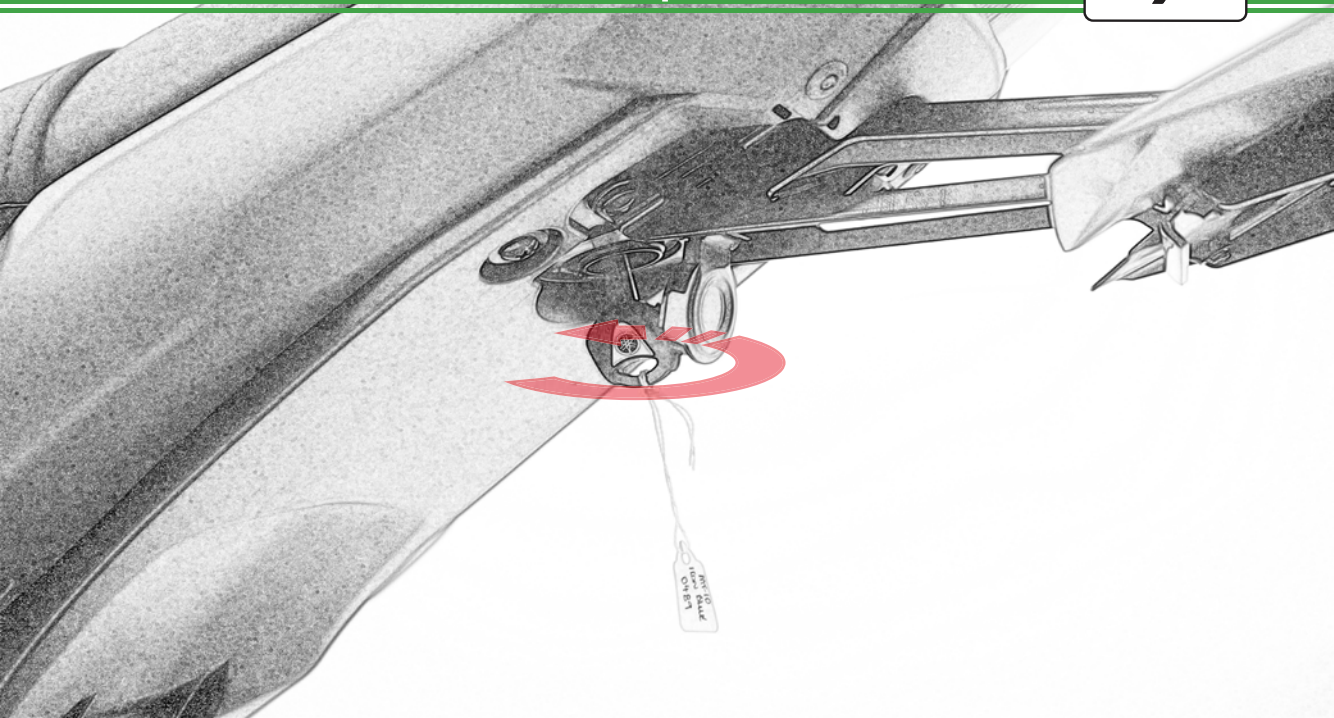

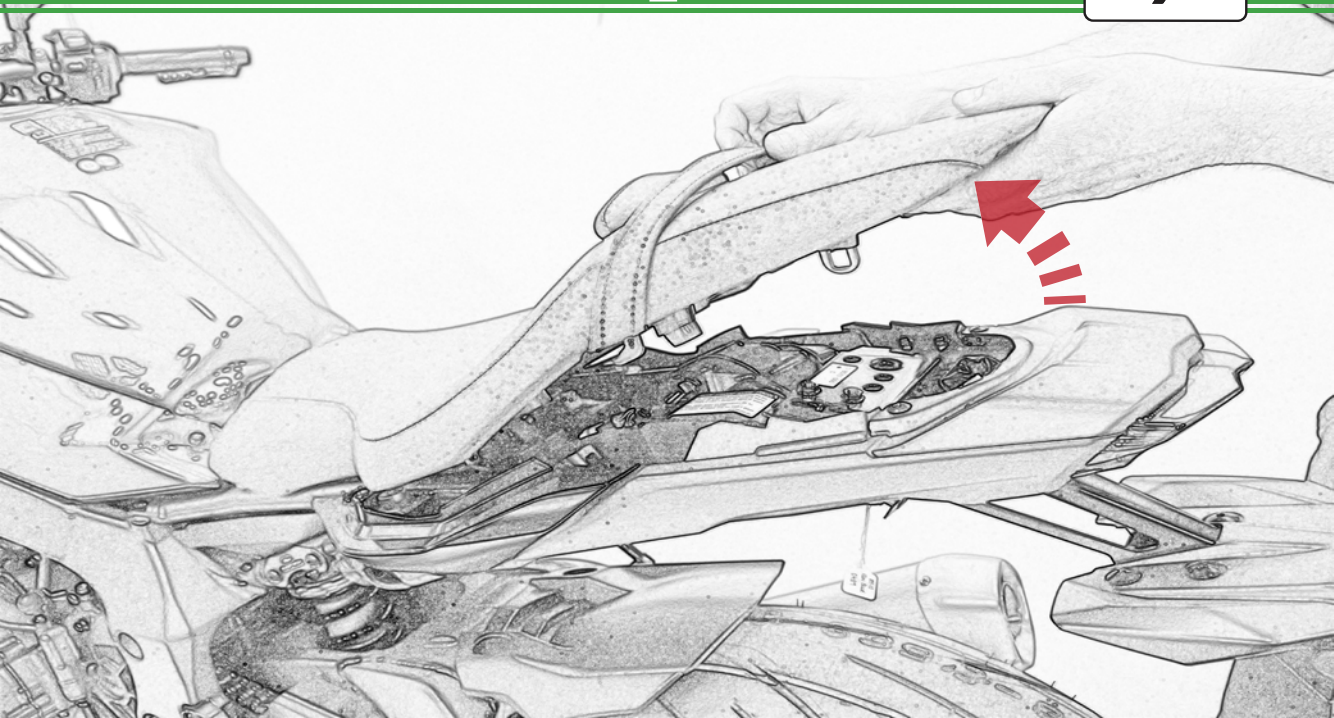

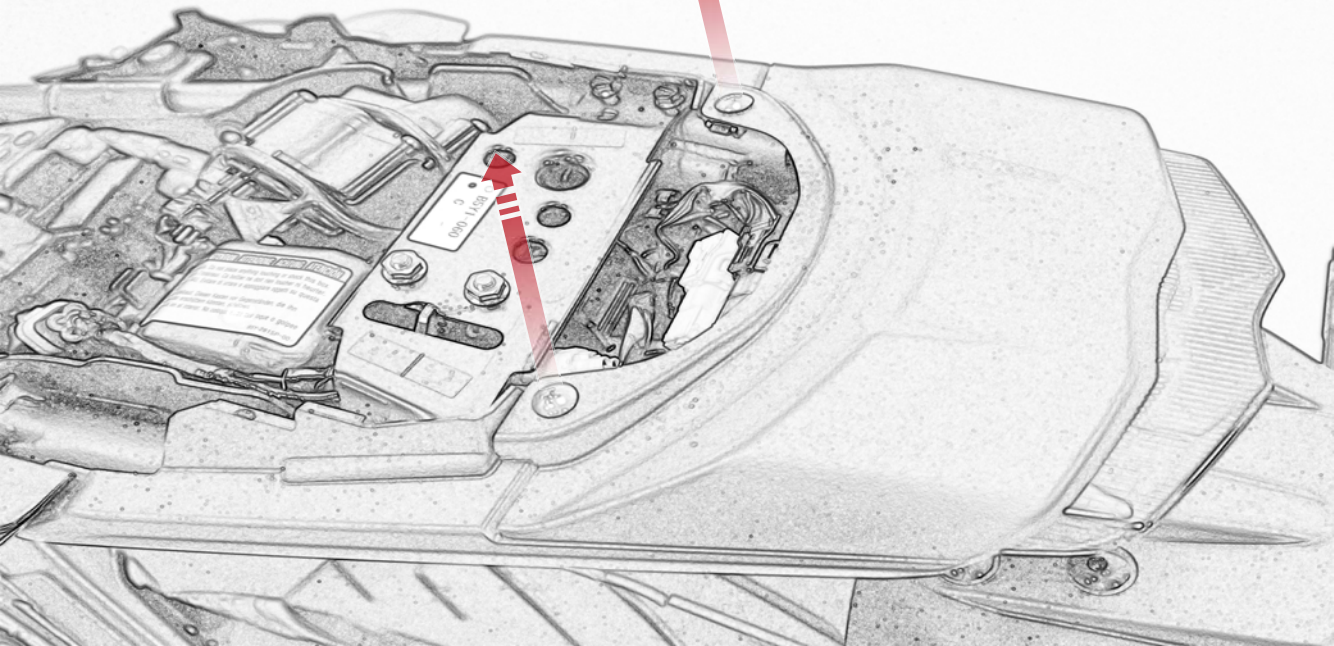

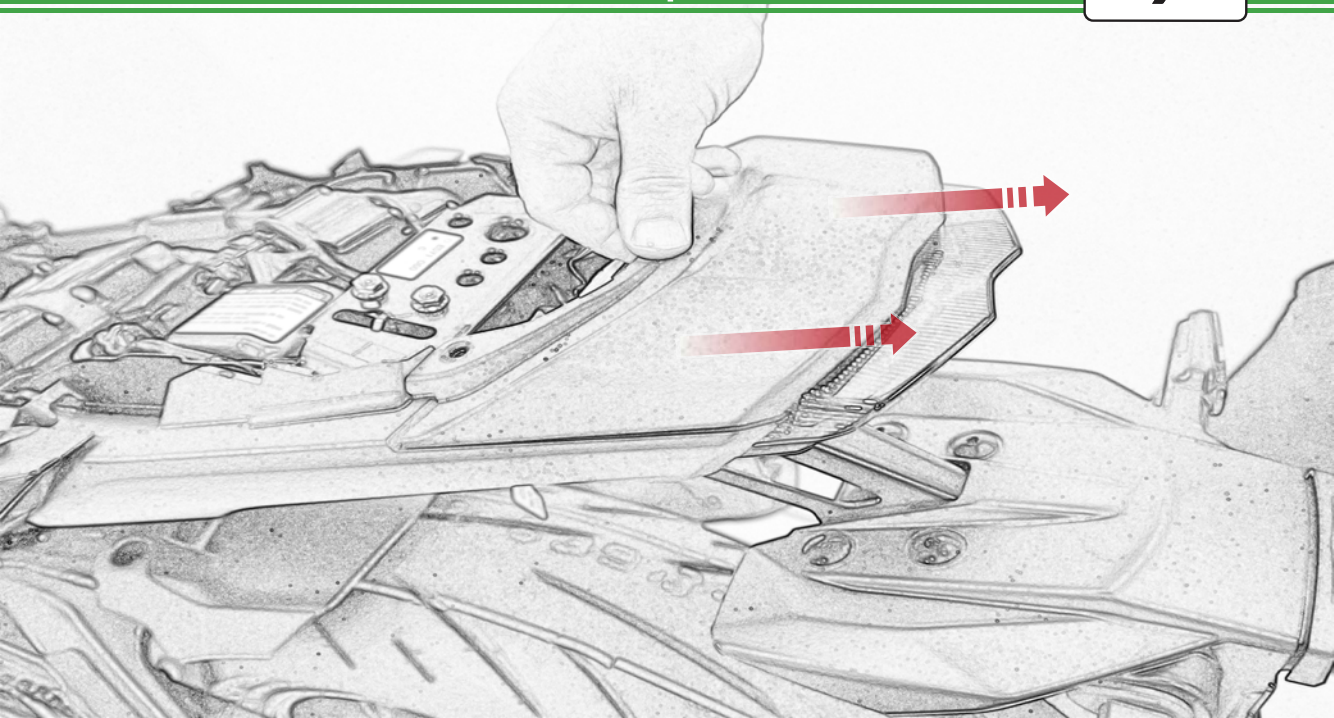

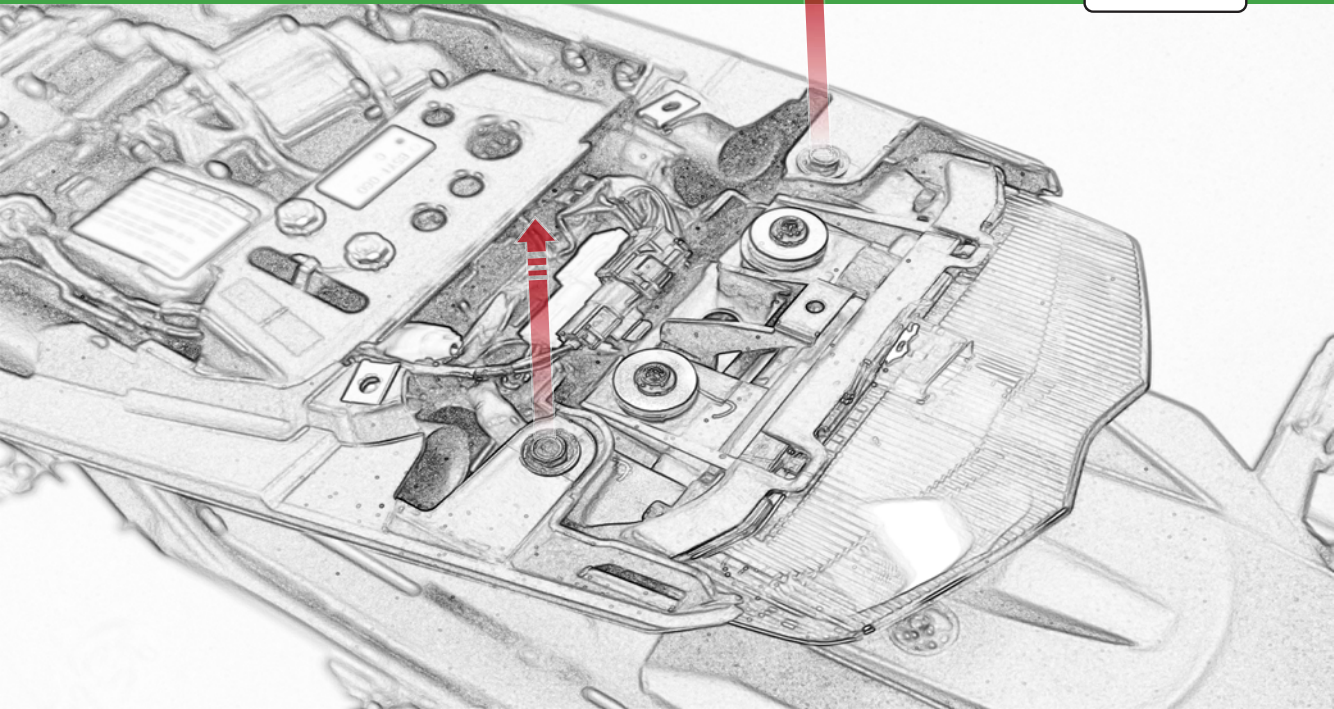

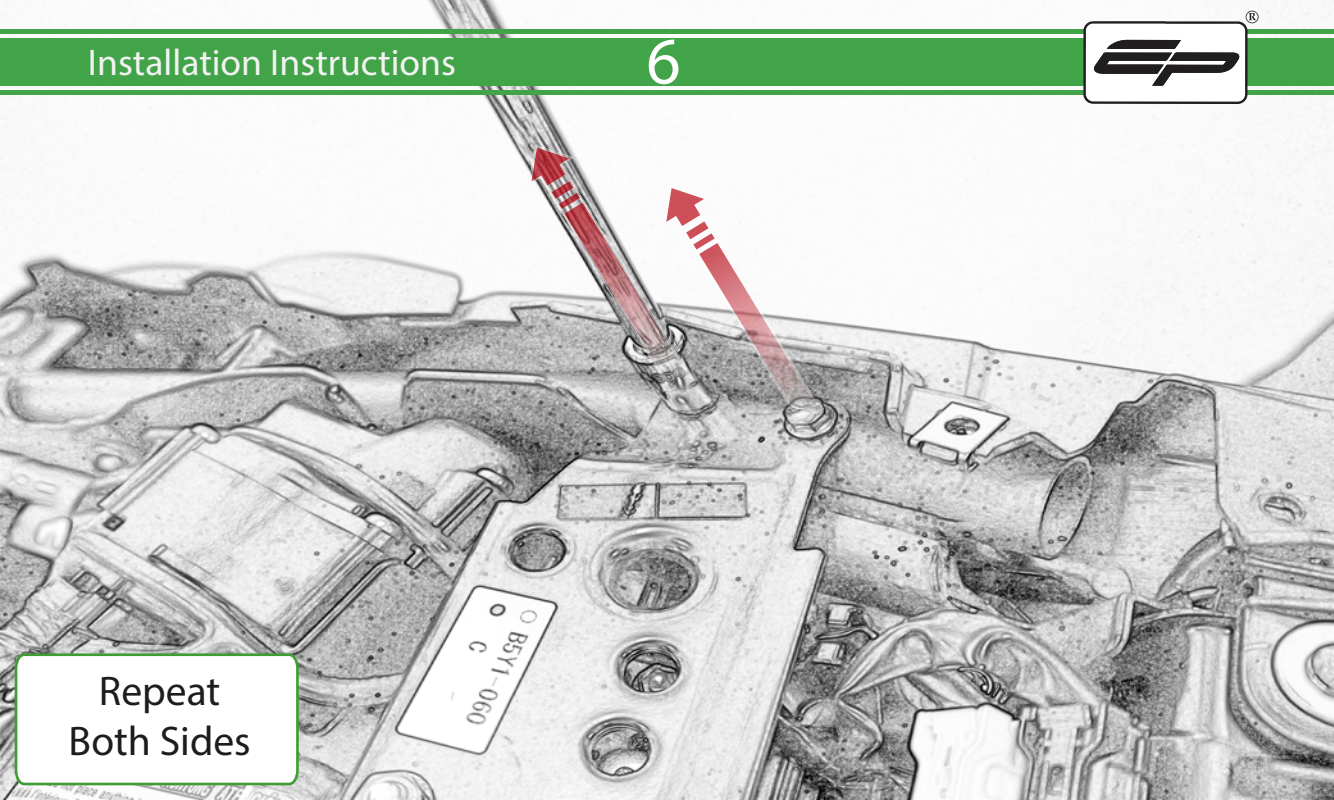

Repeat
Both Sides



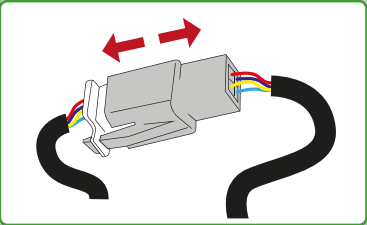
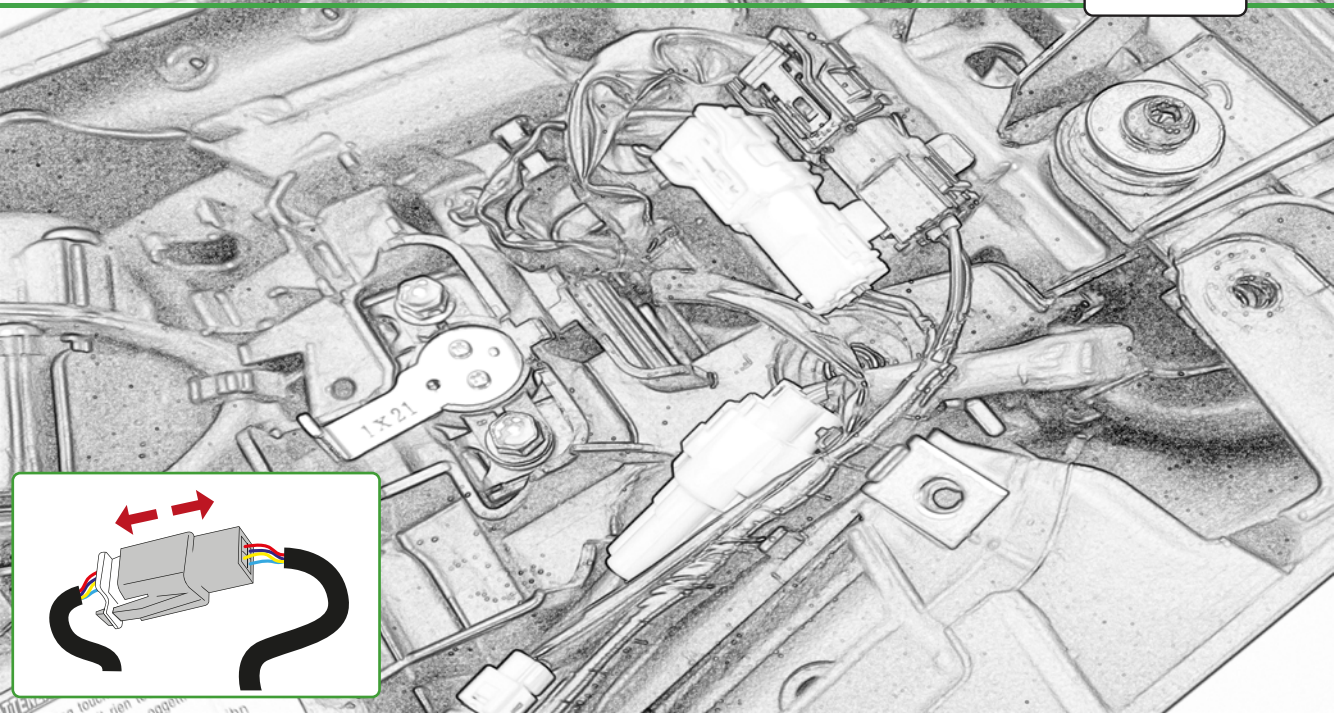

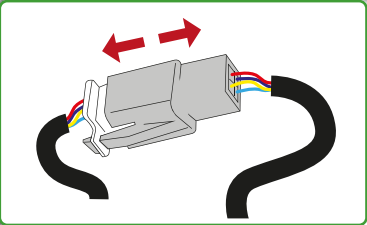

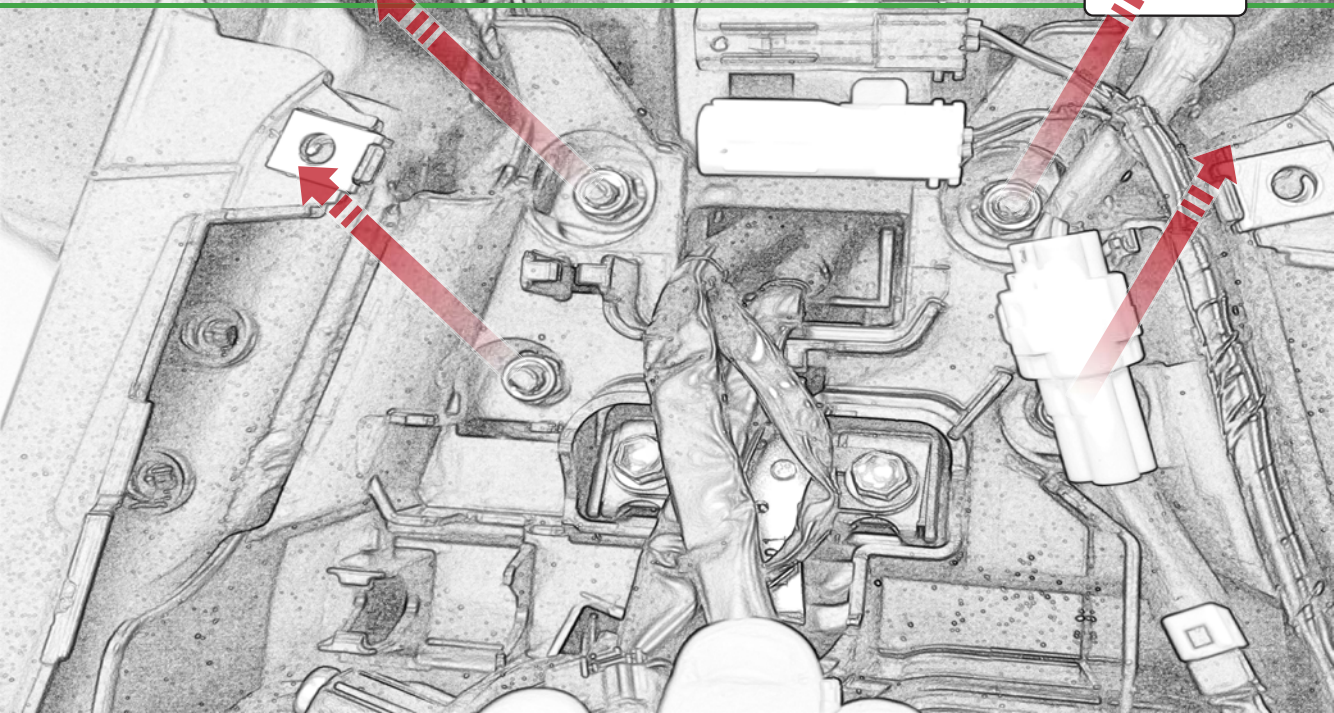



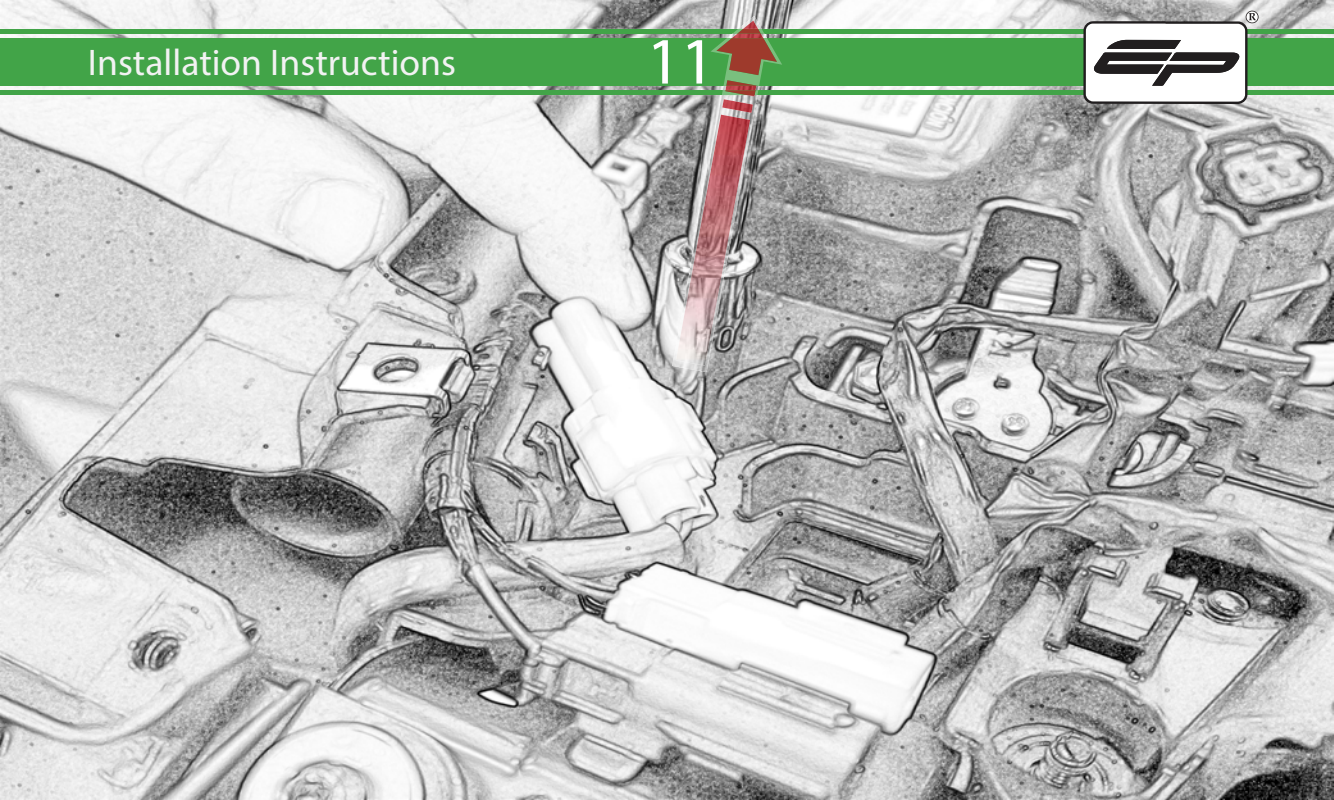

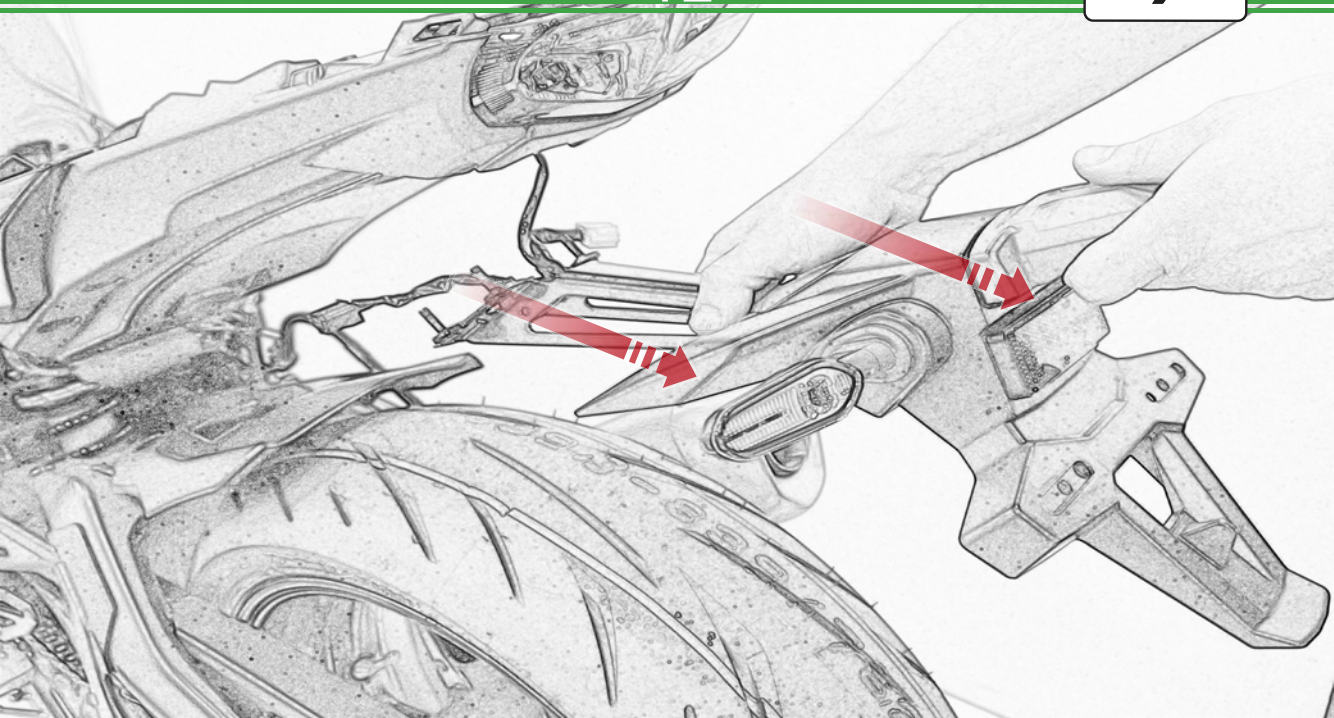

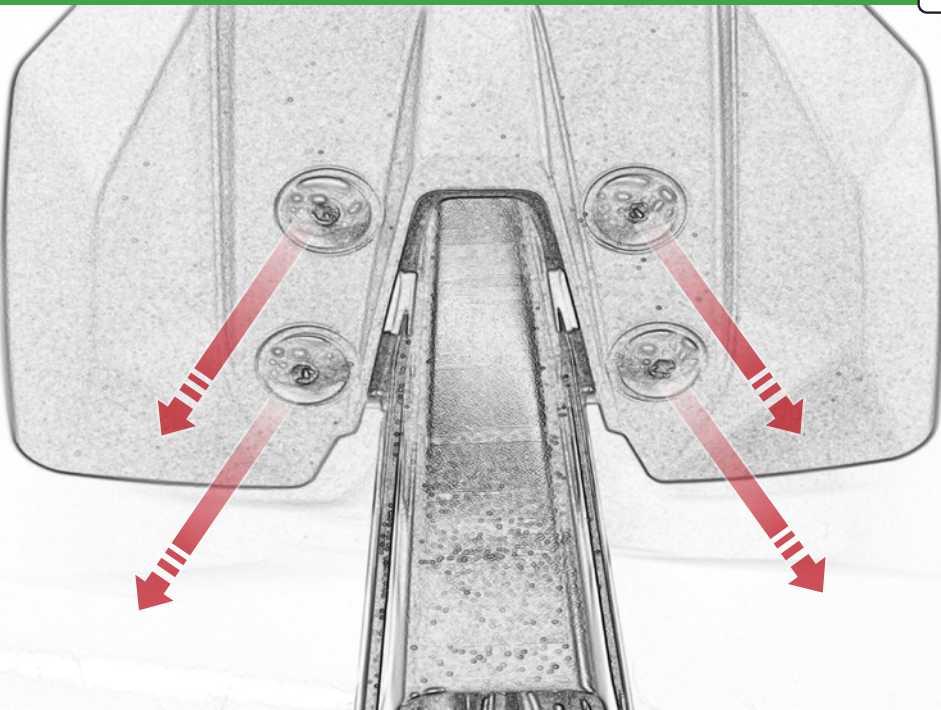

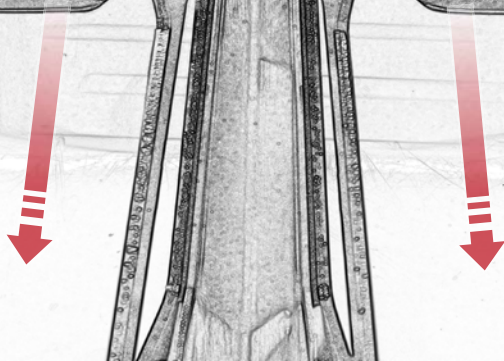

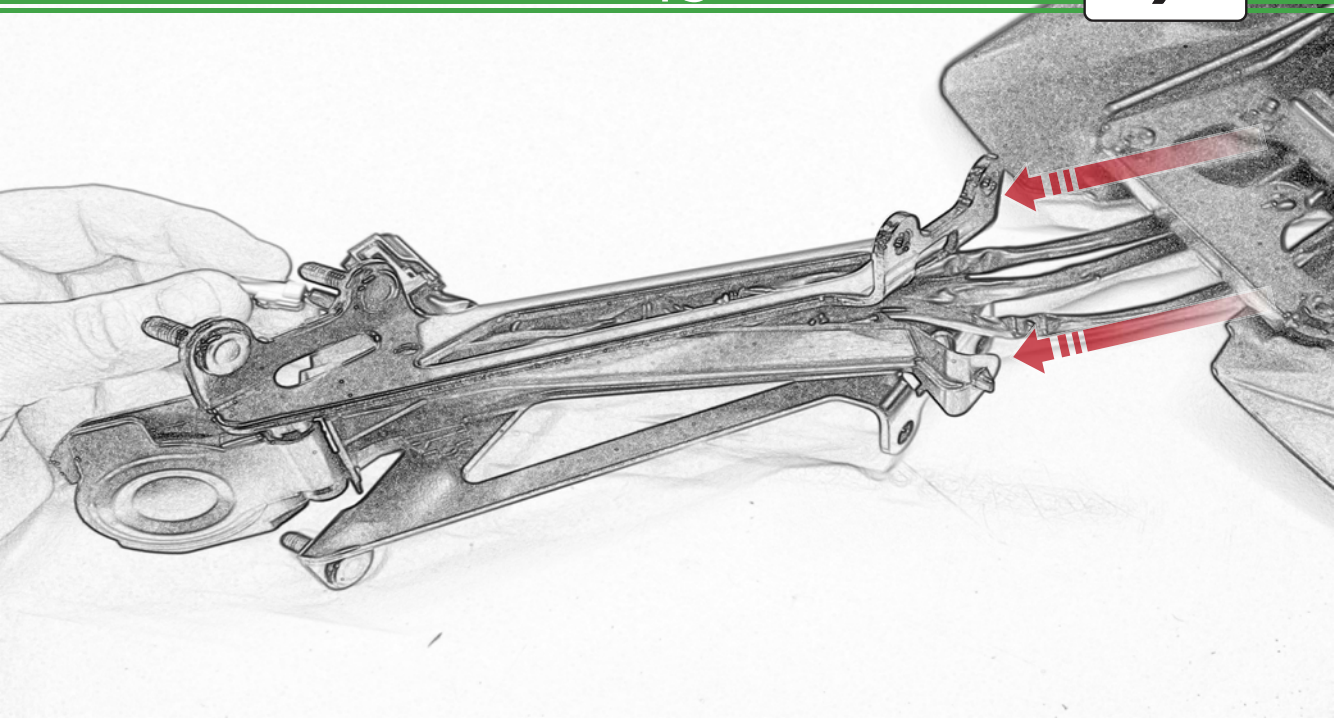

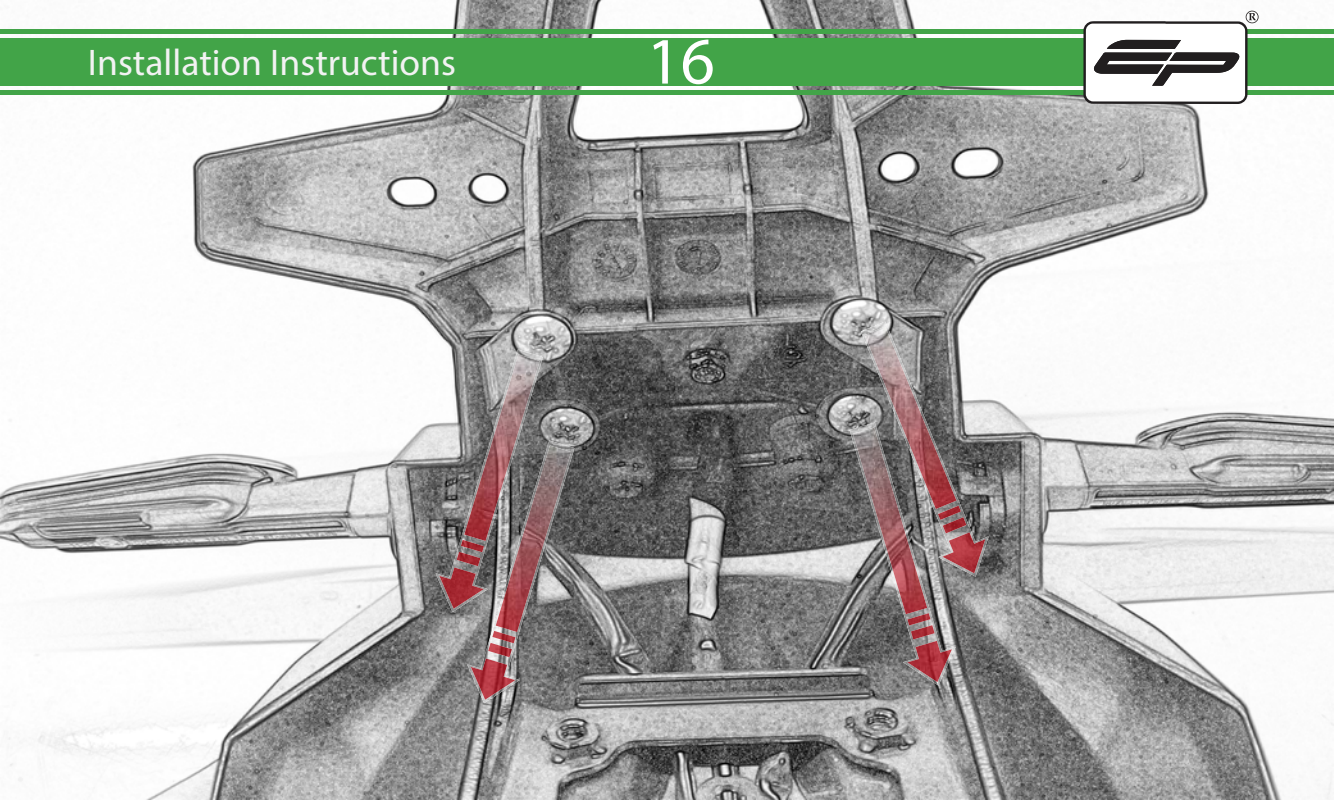

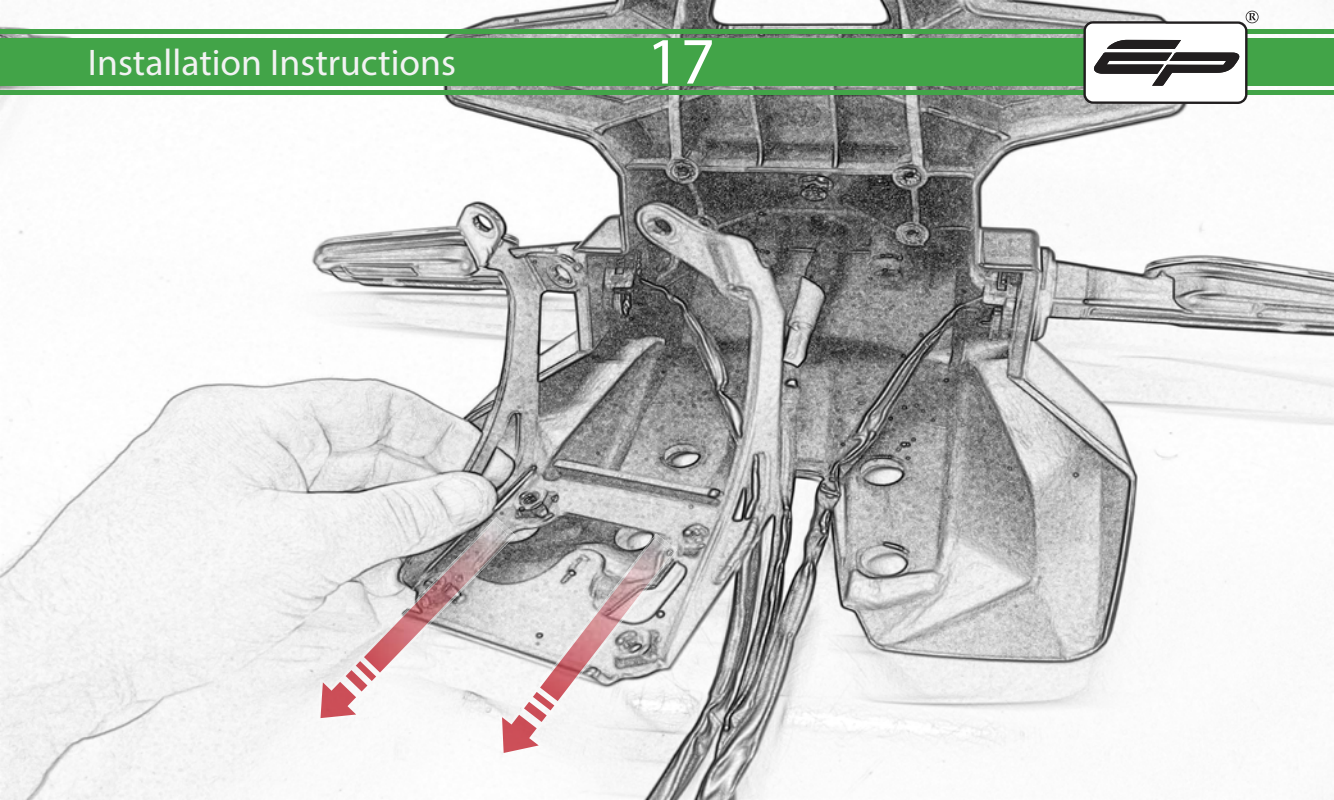

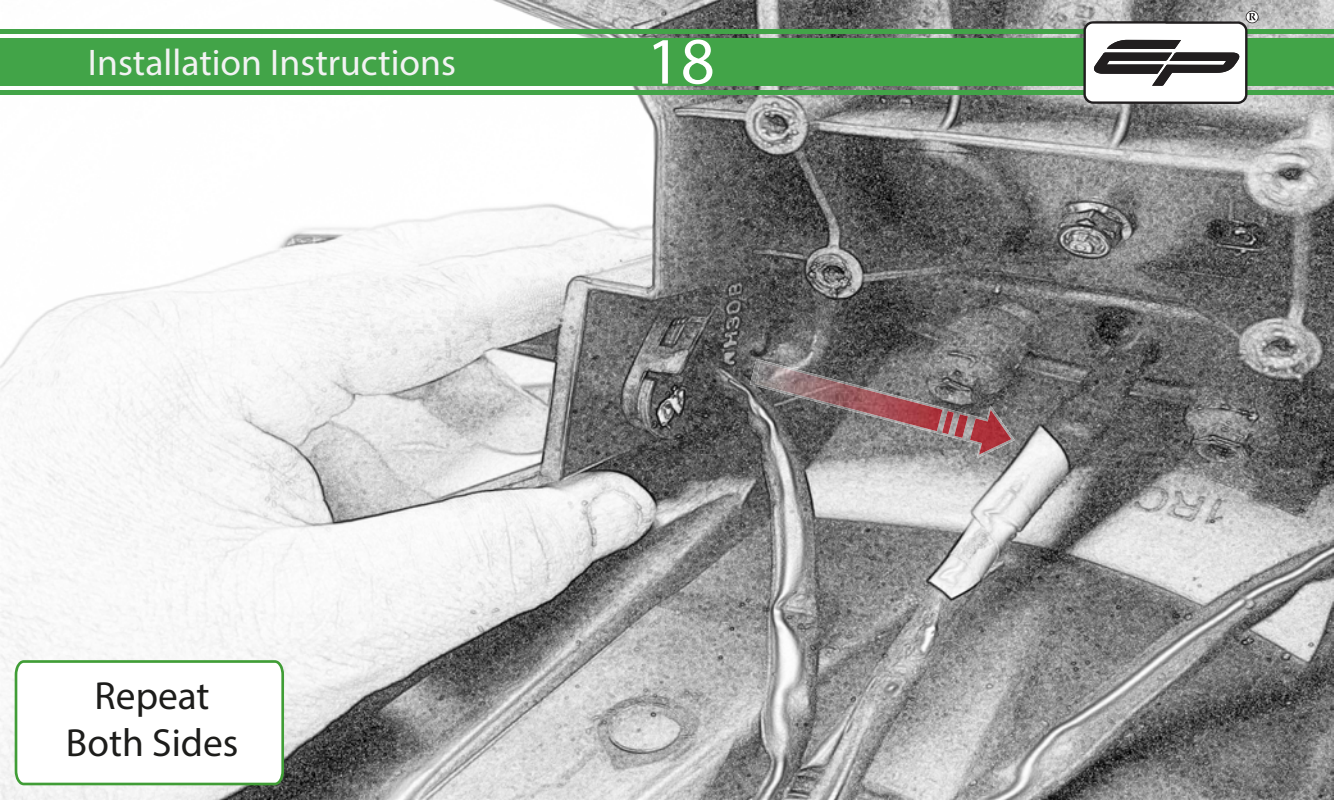

Repeat
Both Sides

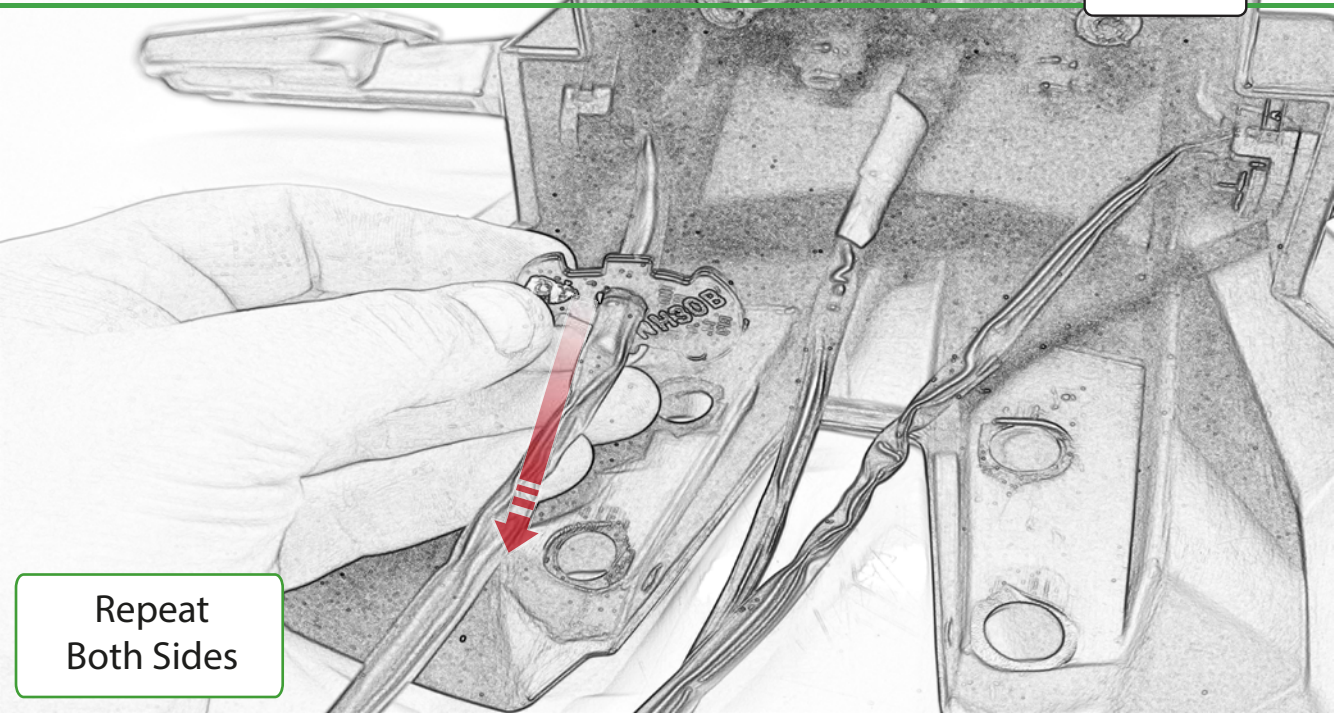

Repeat
Both Sides

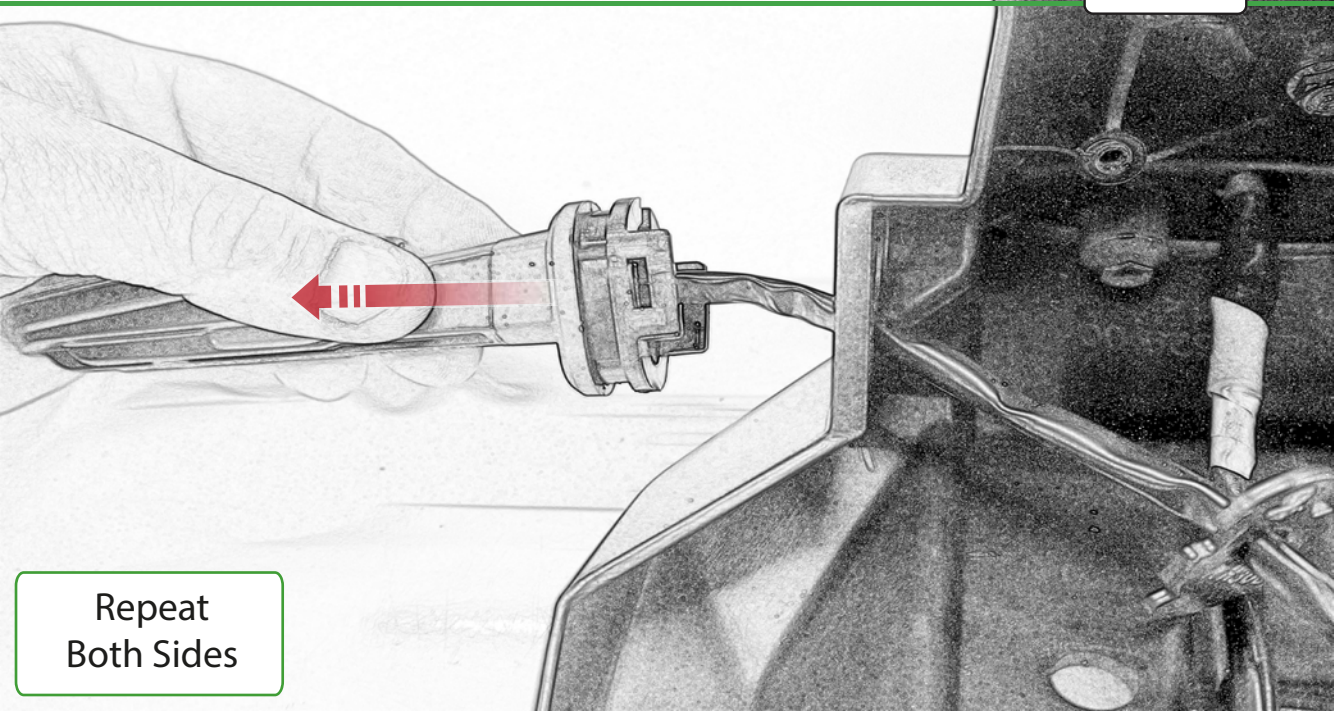

Repeat
Both Sides

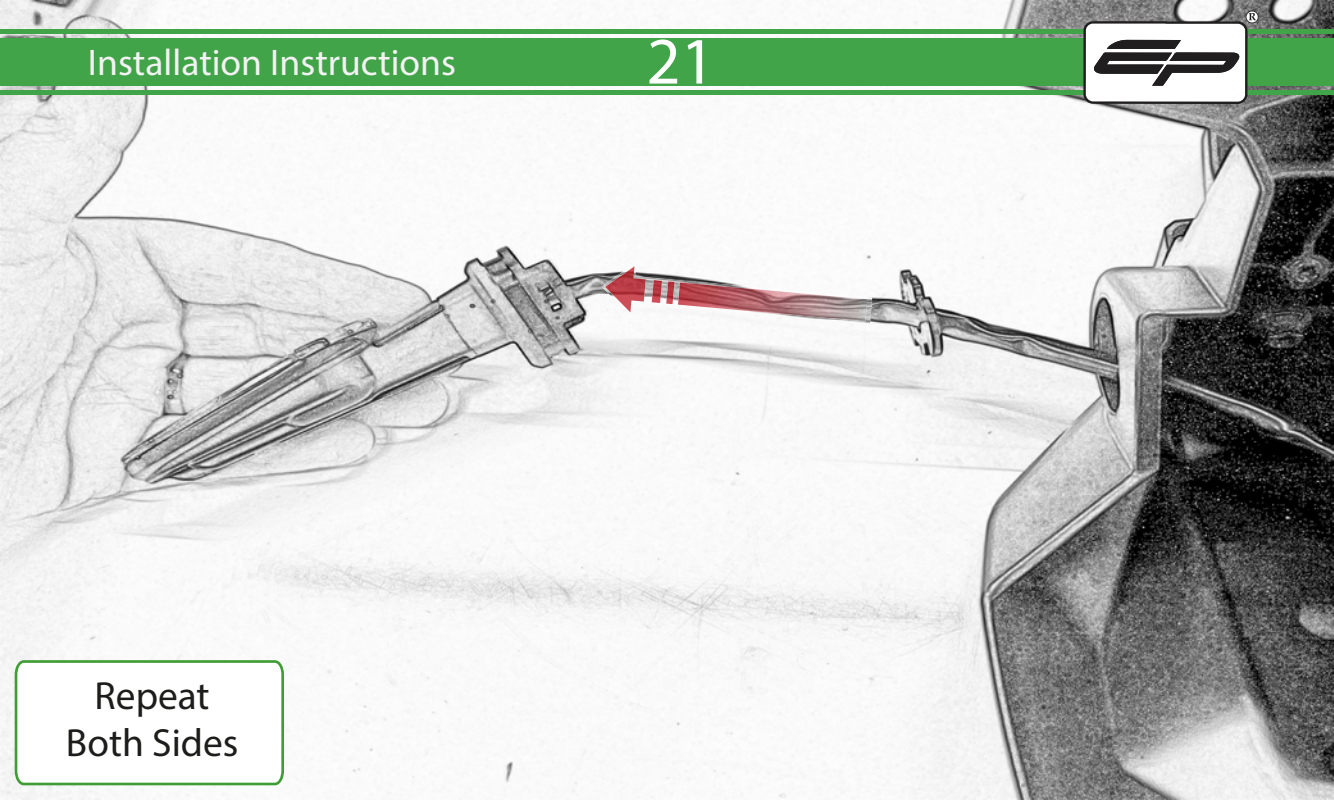

Repeat
Both Sides

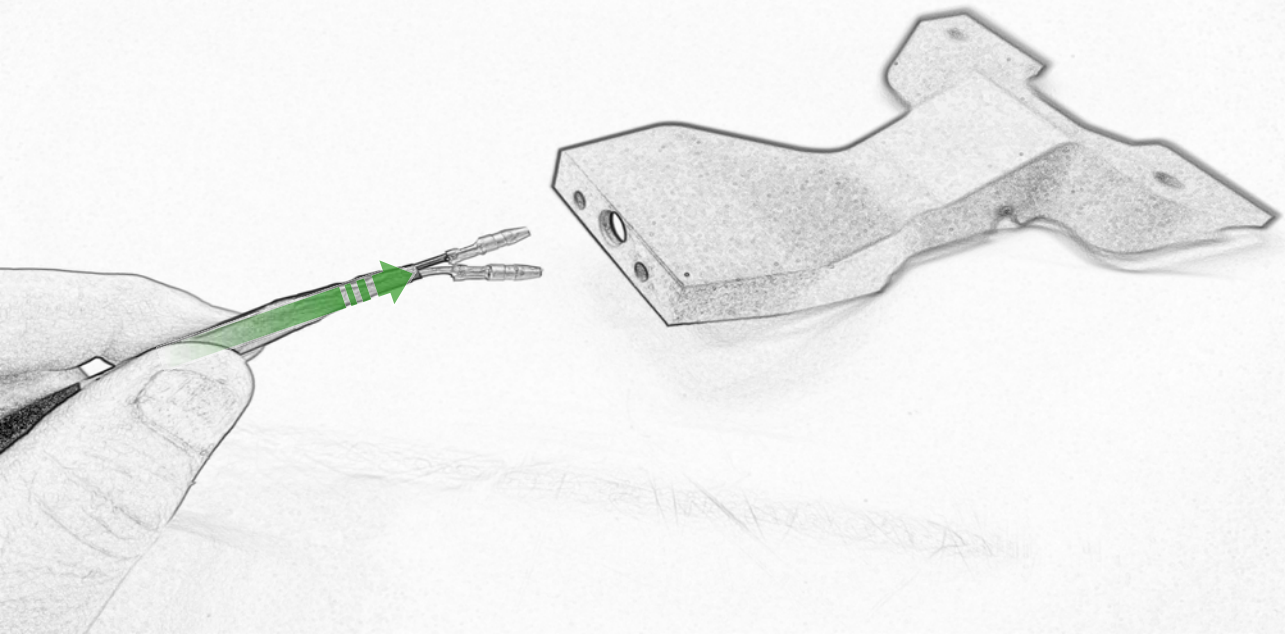

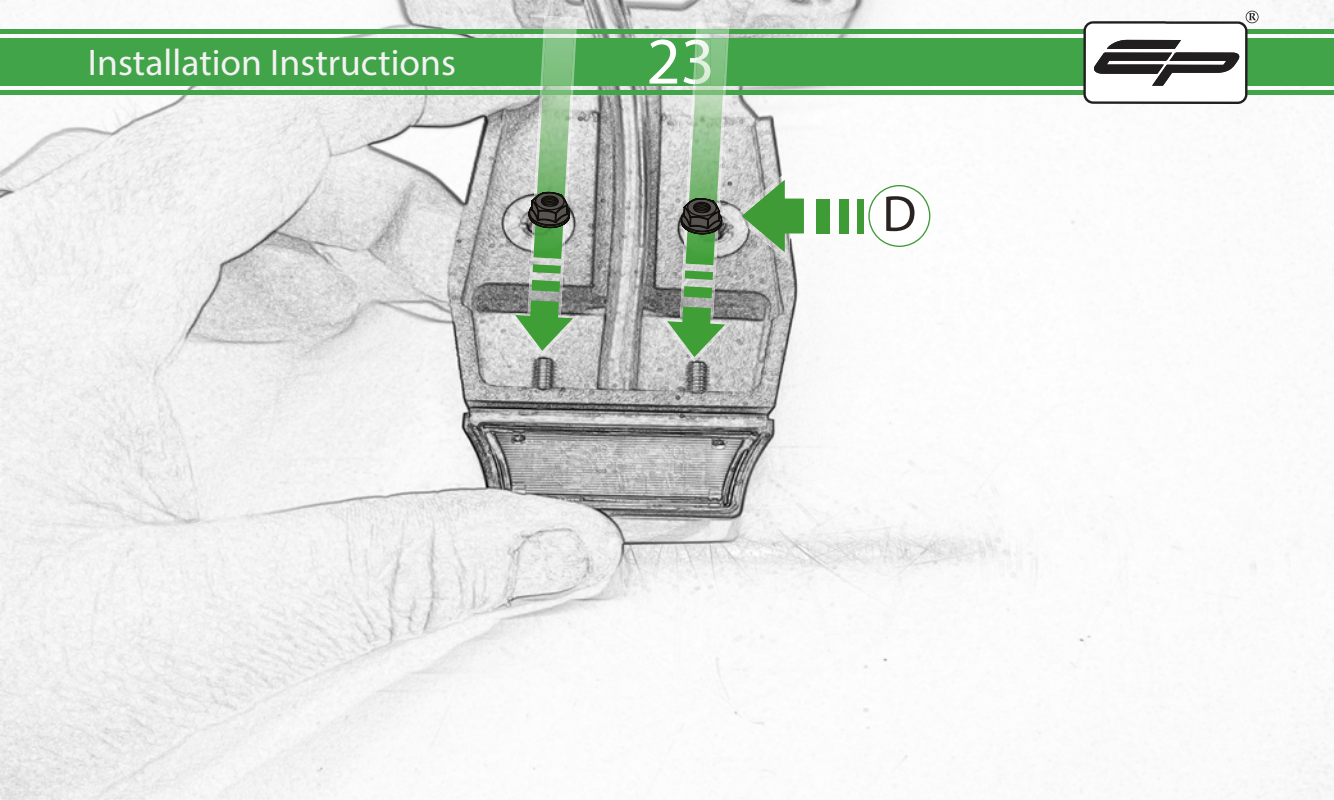

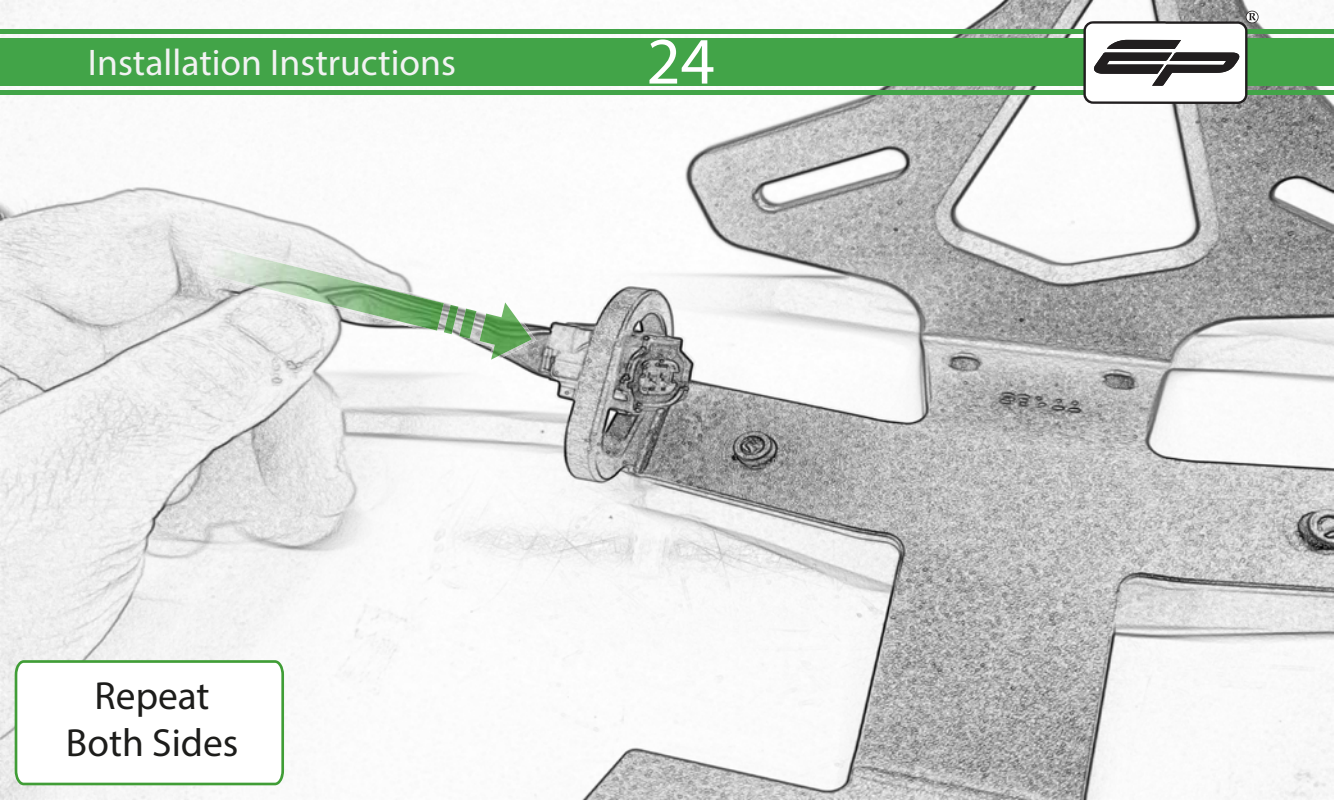

Repeat
Both Sides

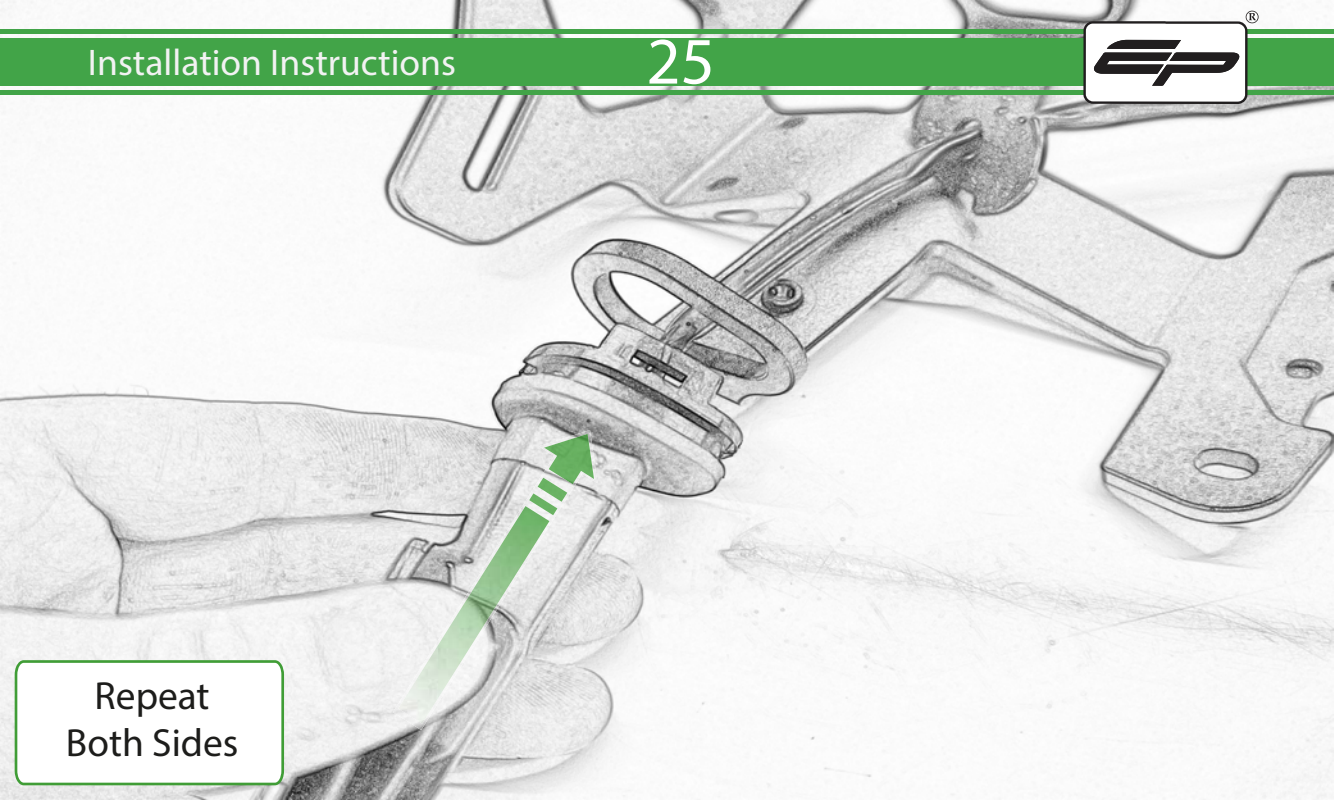

Repeat
Both Sides

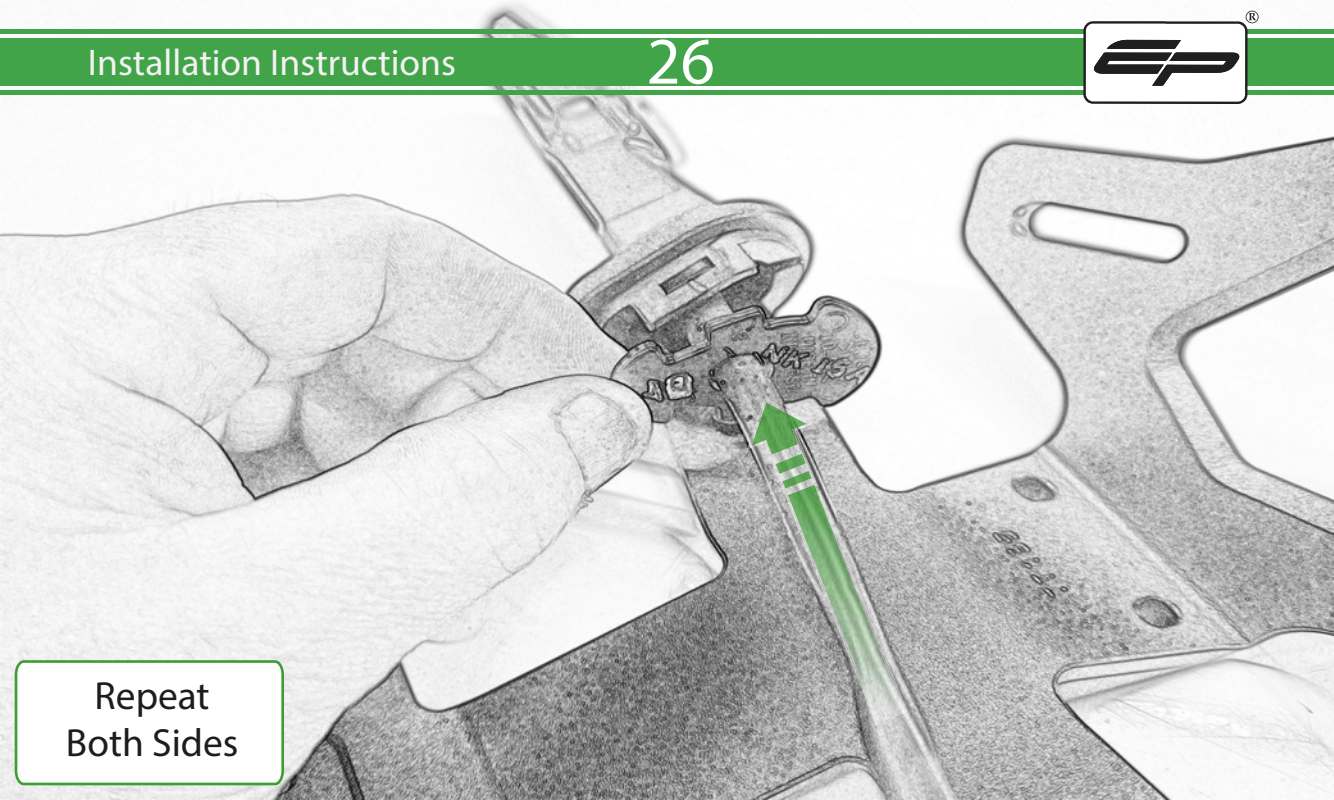

Repeat
Both Sides

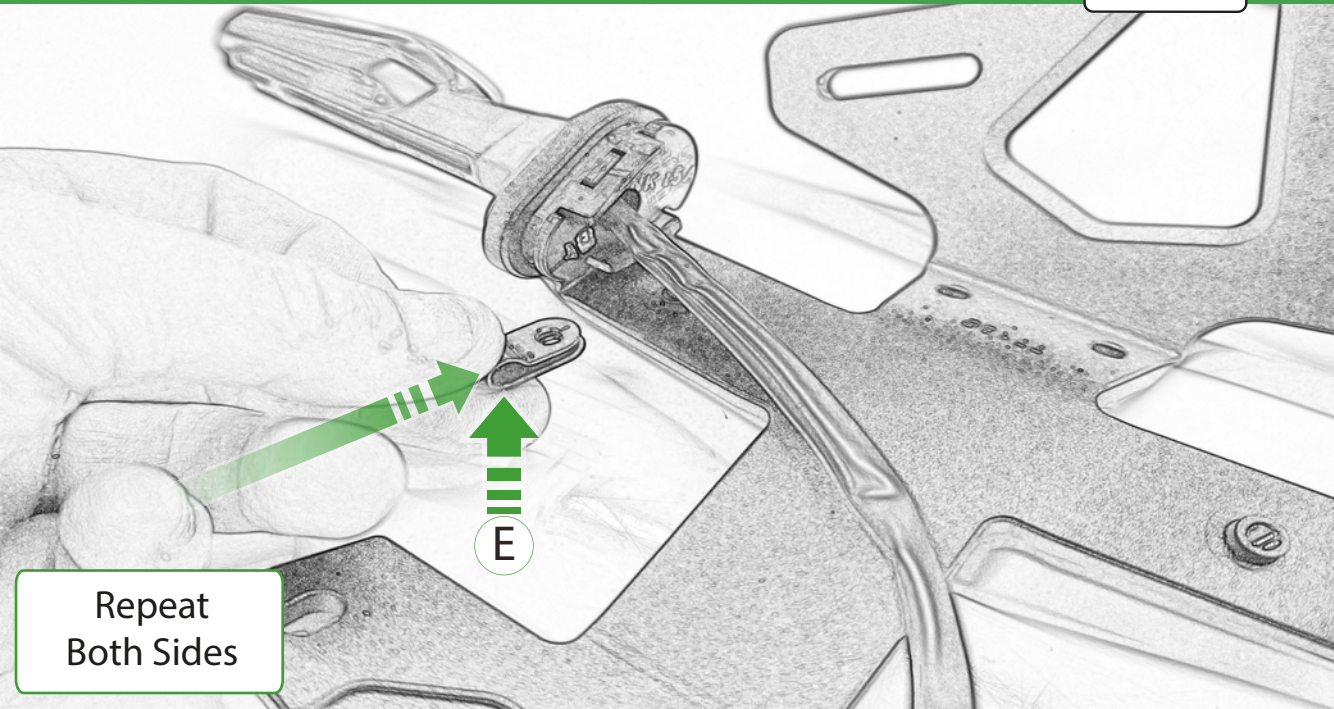

Repeat
Both Sides

E

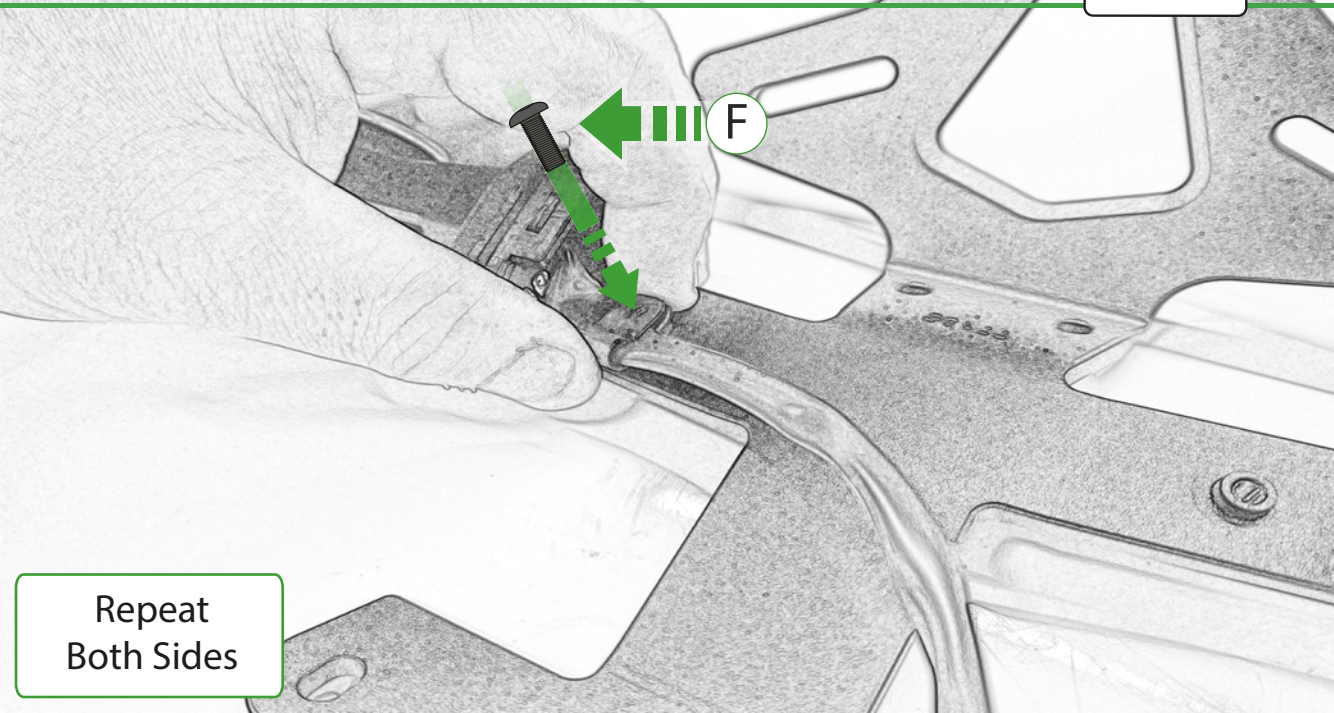

Repeat
Both Sides

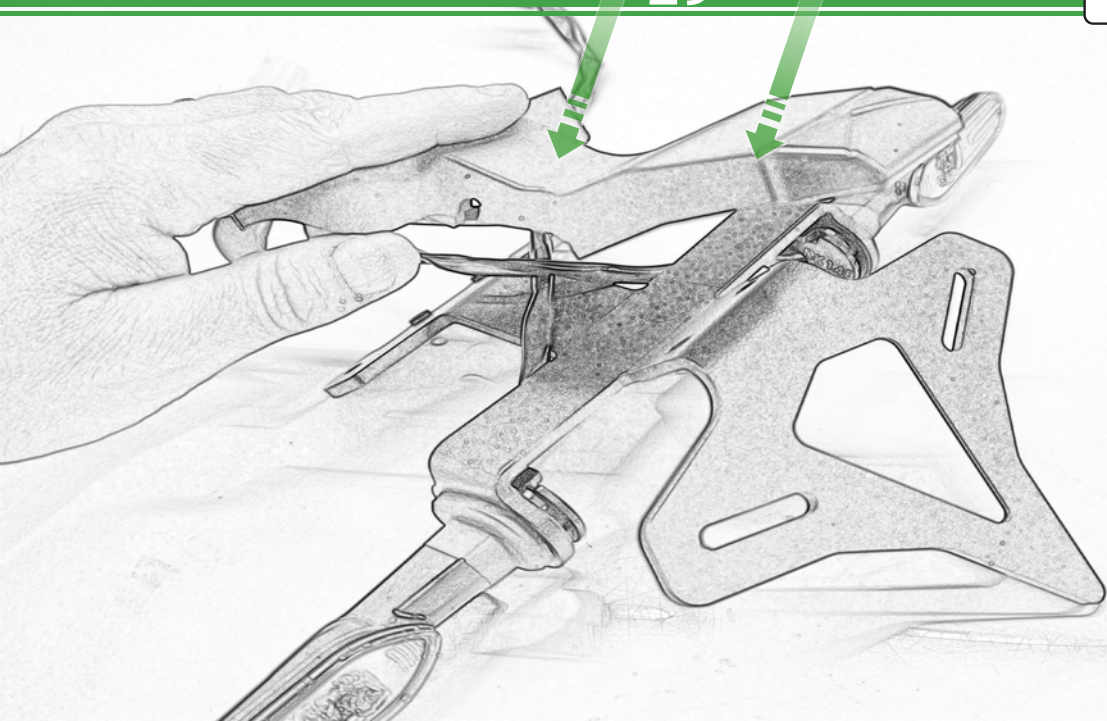

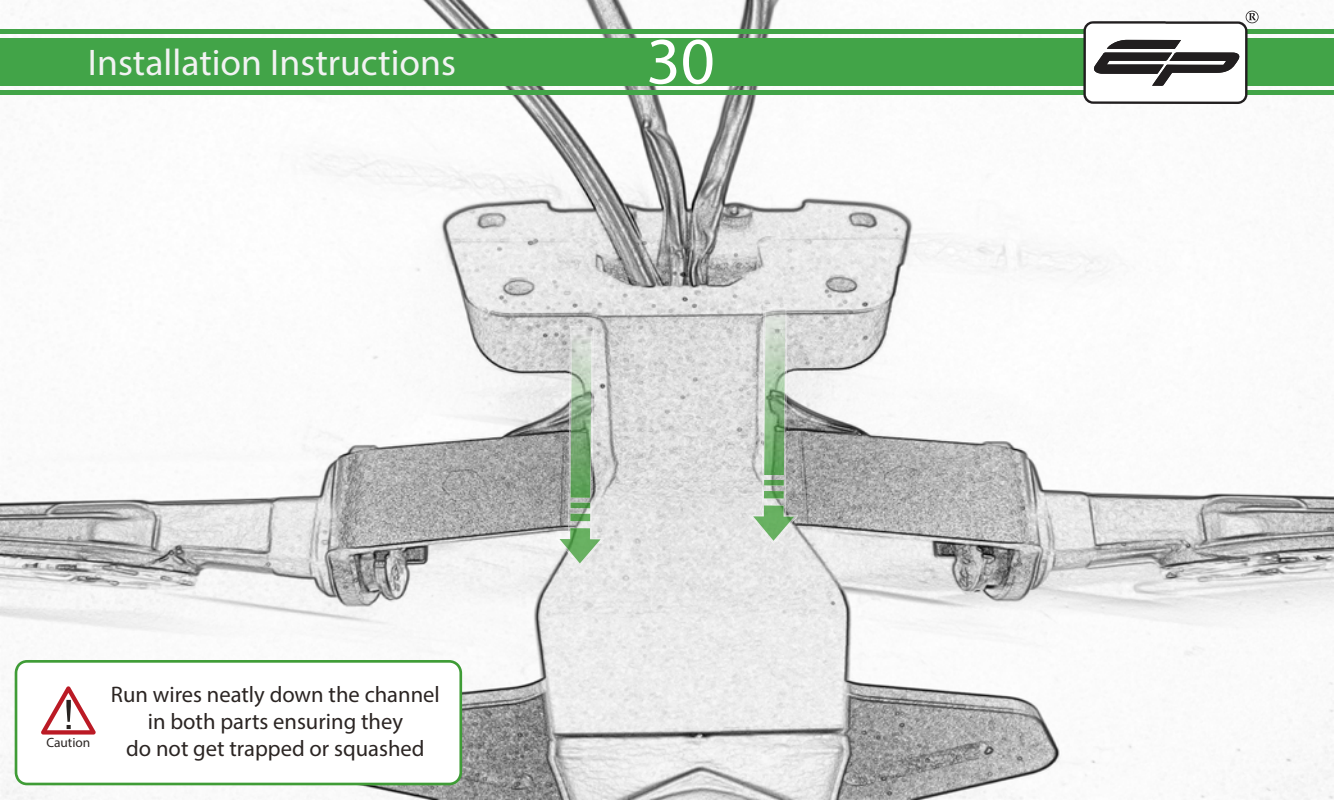

Caution

Run wires neatly down the channel in both parts ensuring they do not get trapped or squashed

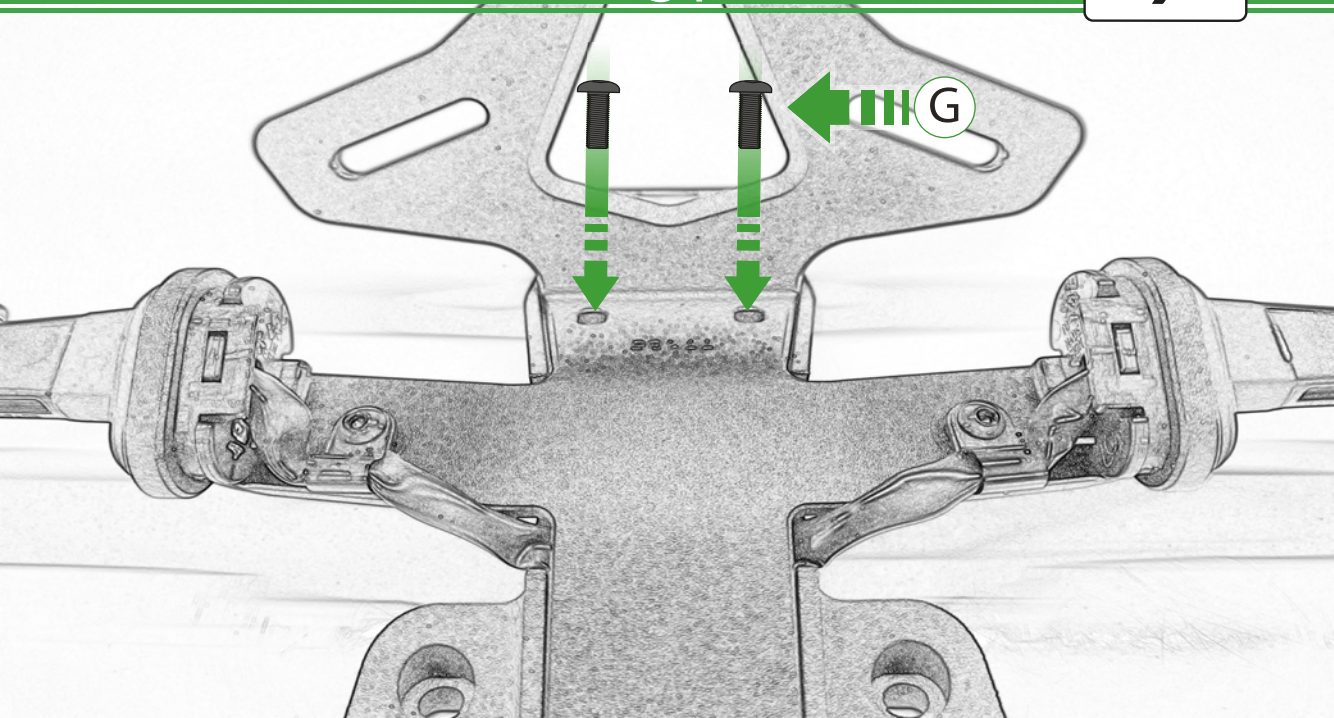

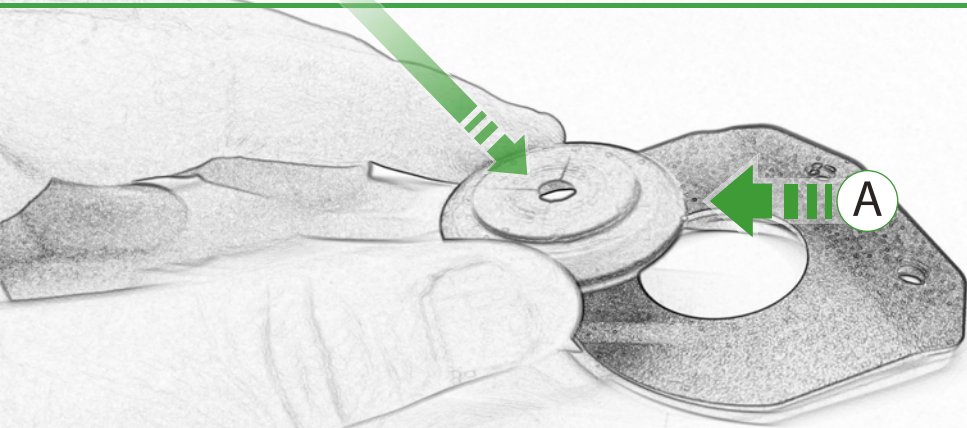

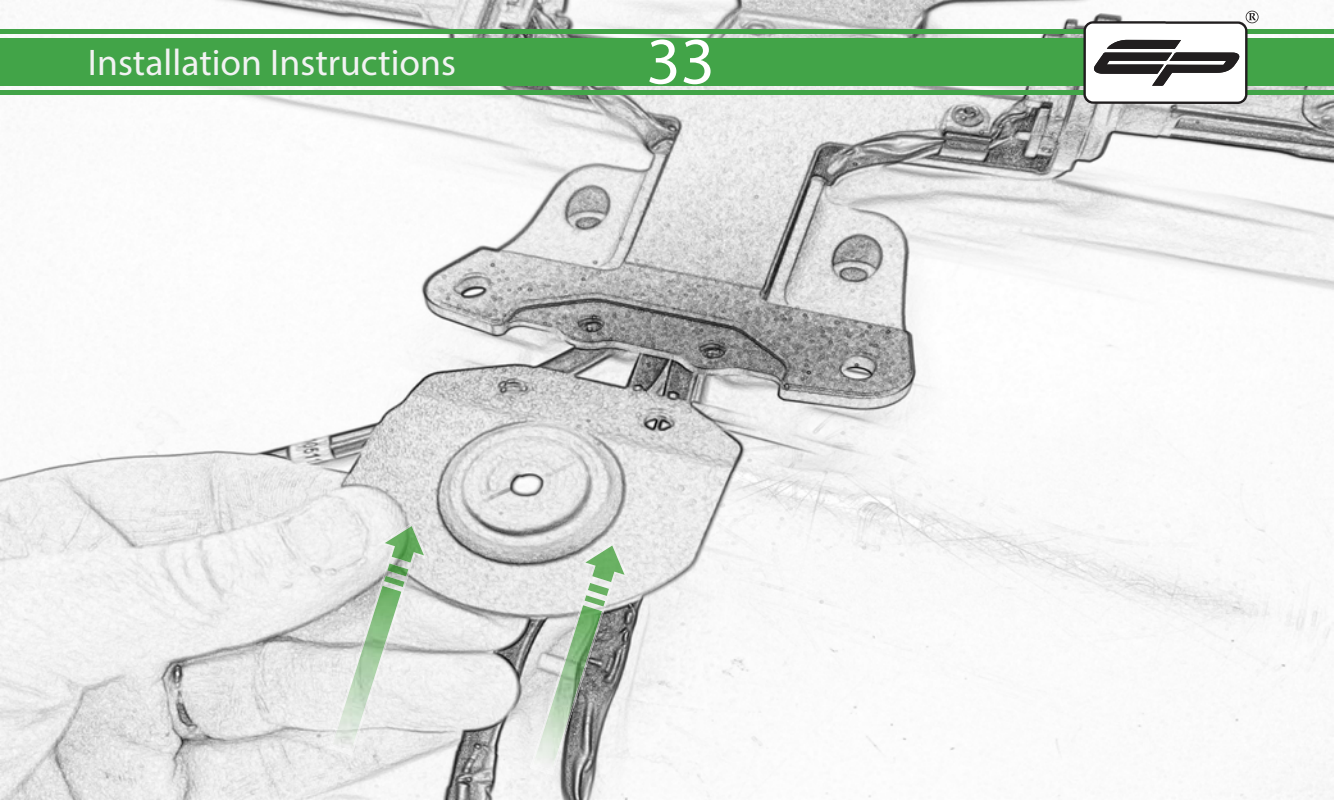

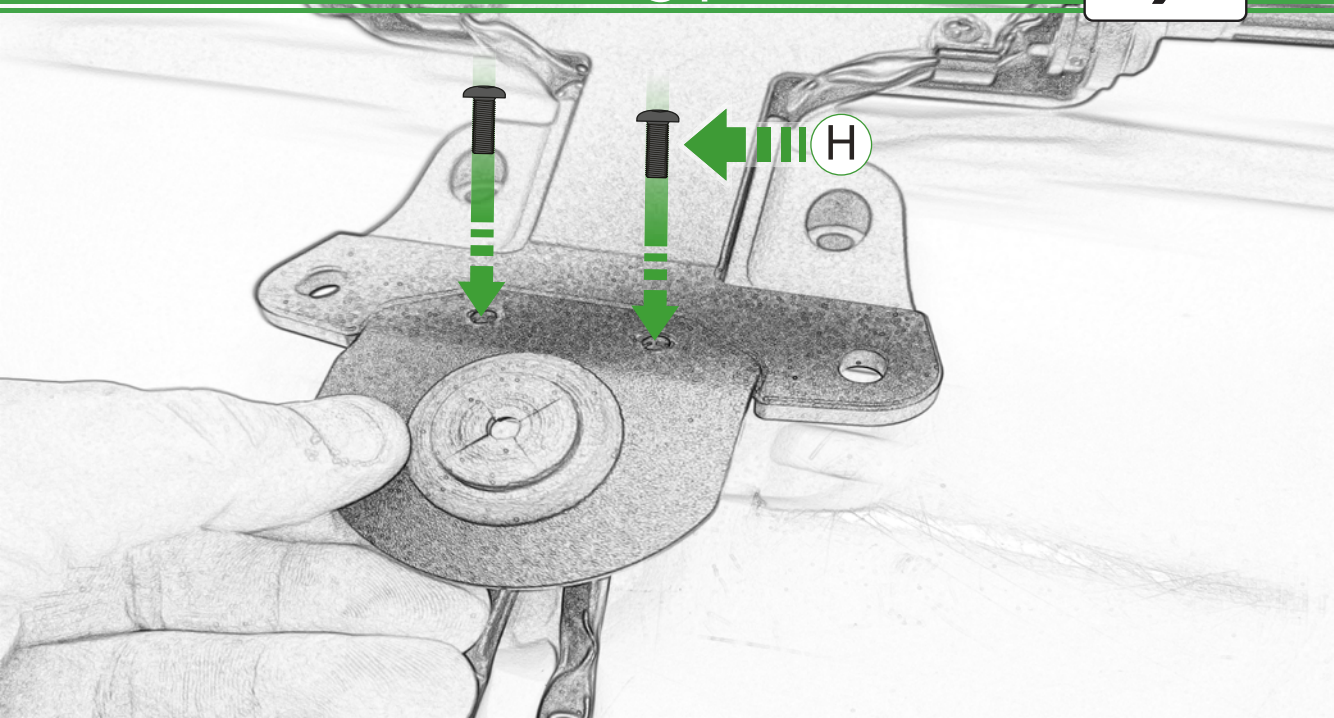

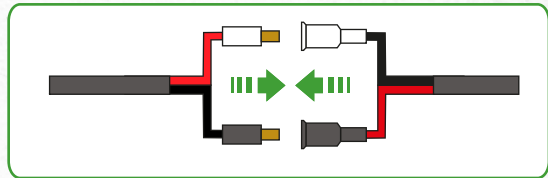
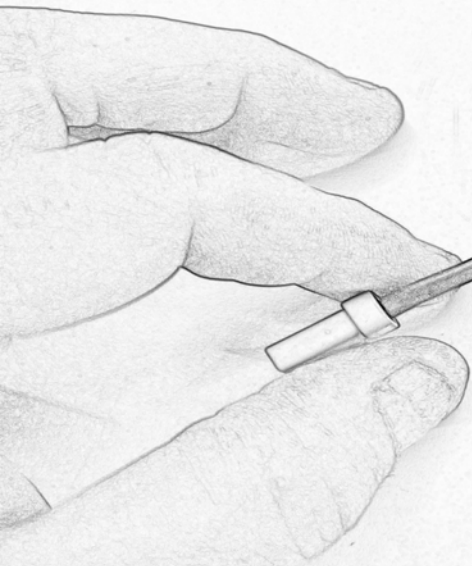

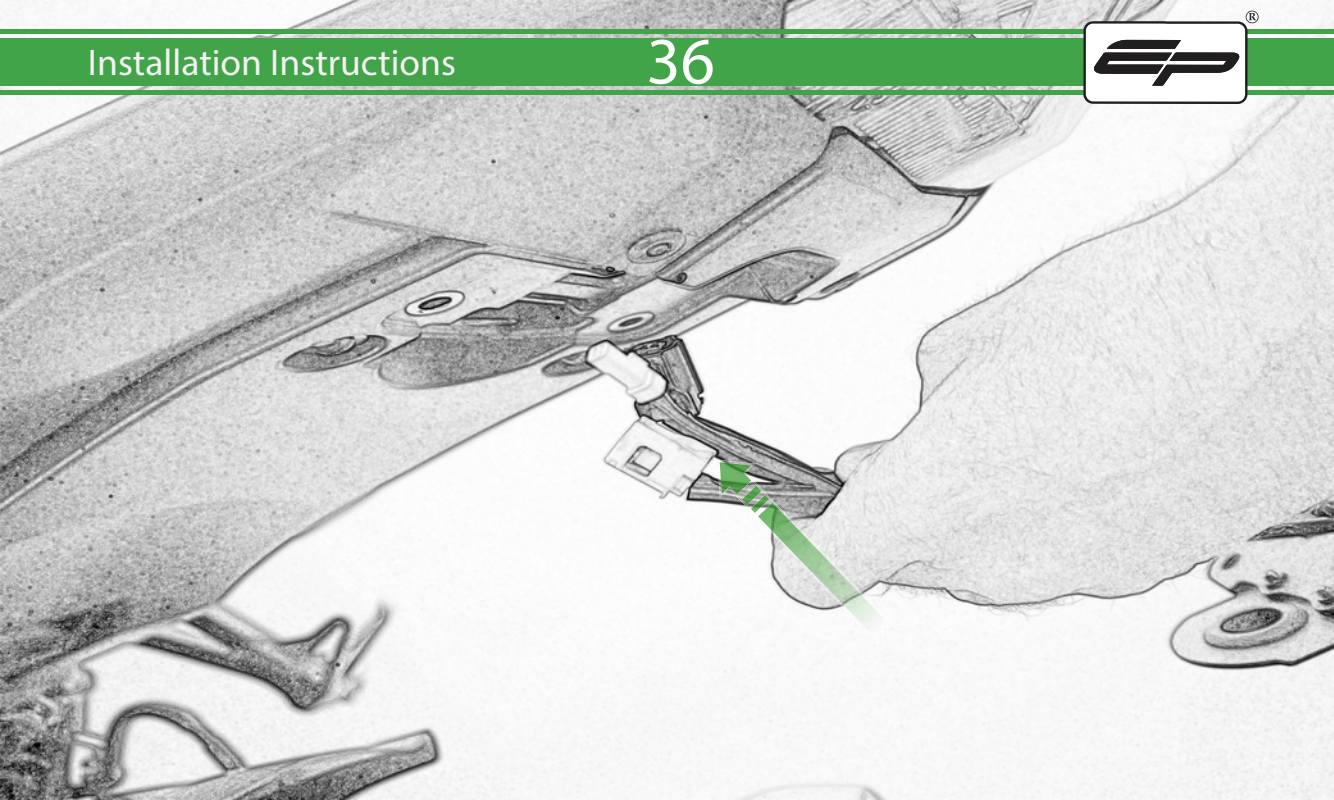

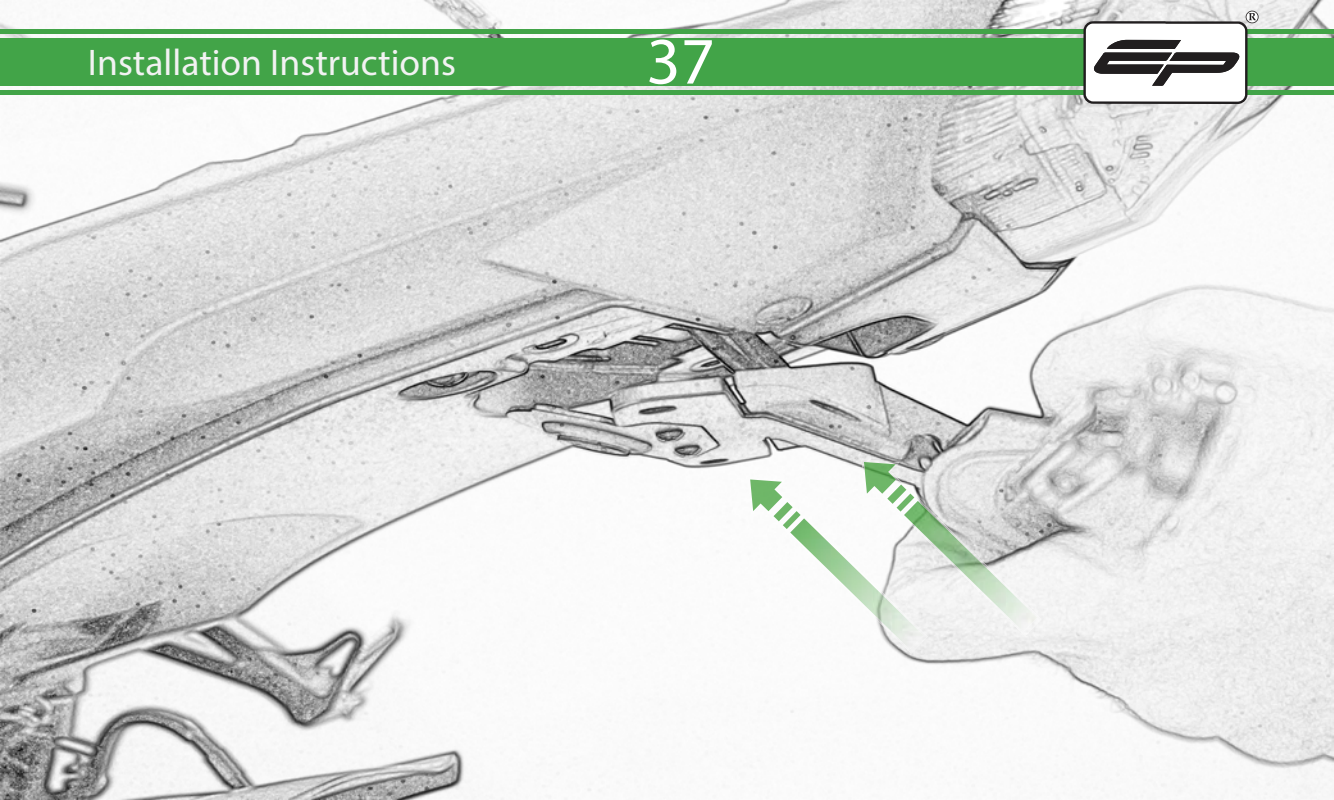

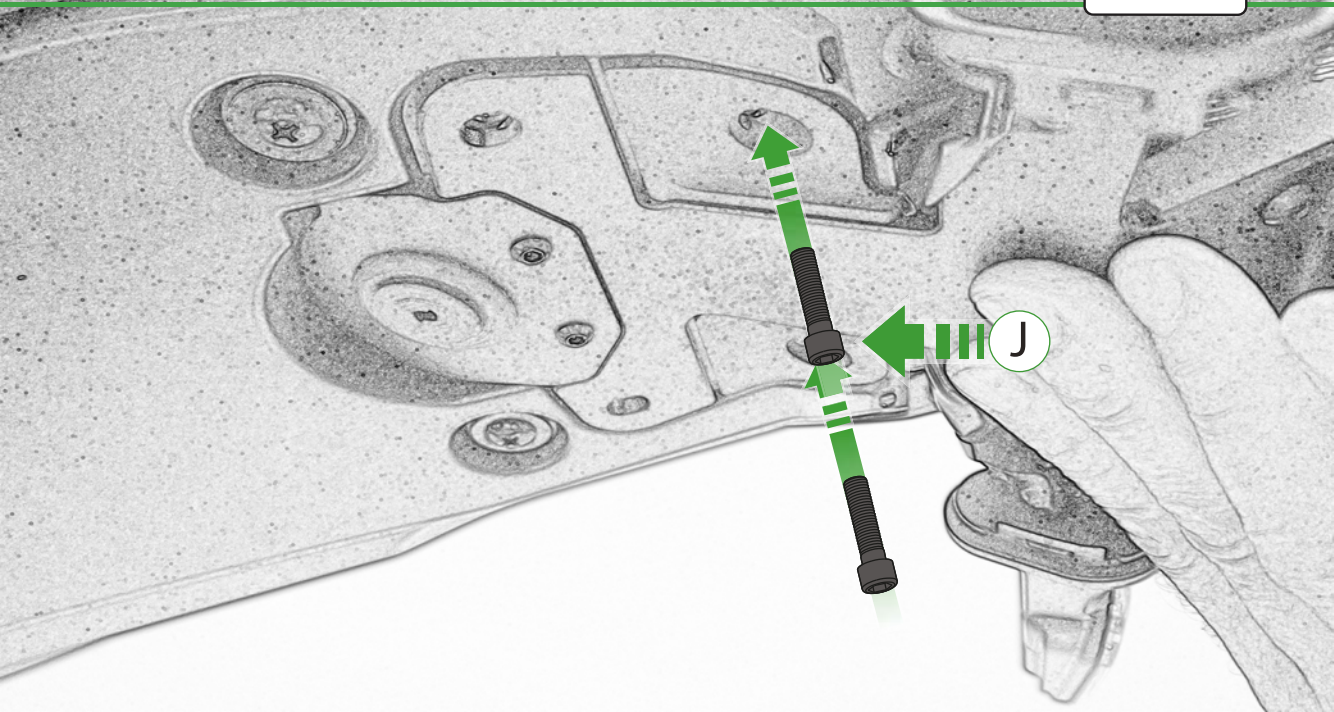

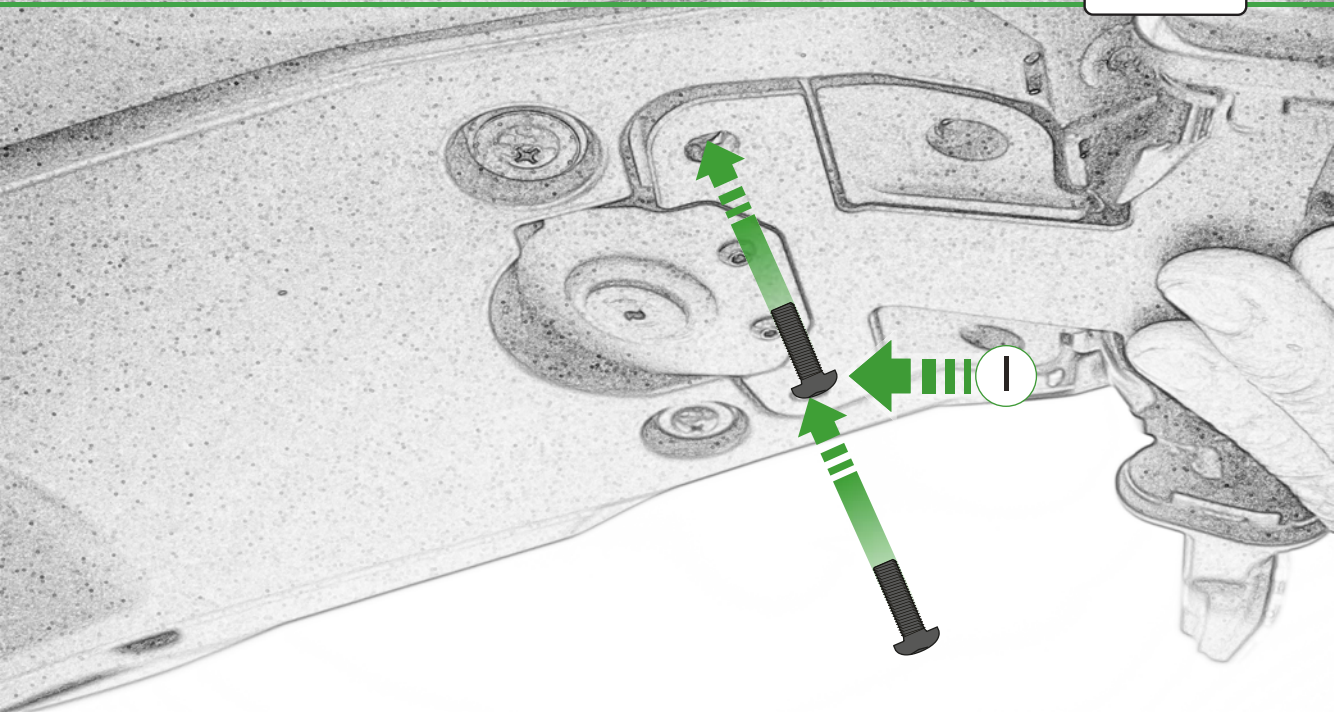

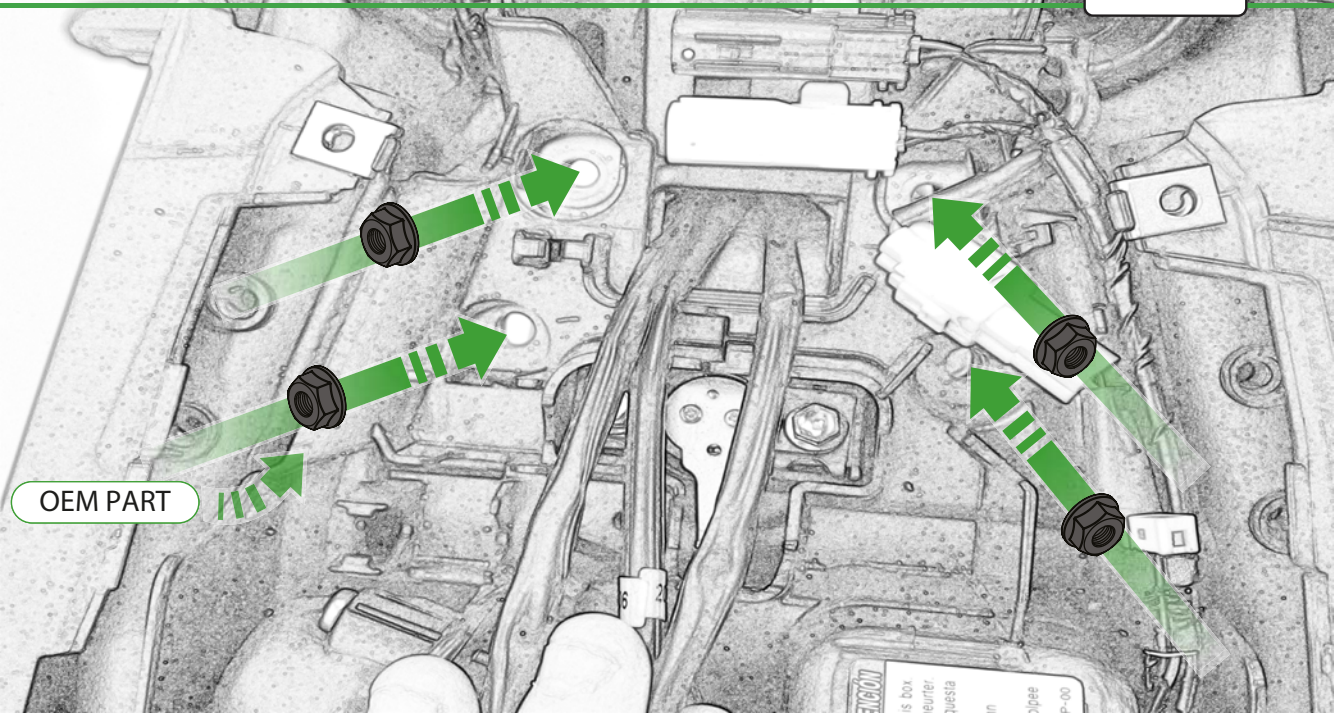

OEM PART

INFORMACIÓN
This box
is for
reorder
quantity
in
pieces
P-00



EVOTECH[®]
P E R F O R M A N C E

Installation Instructions

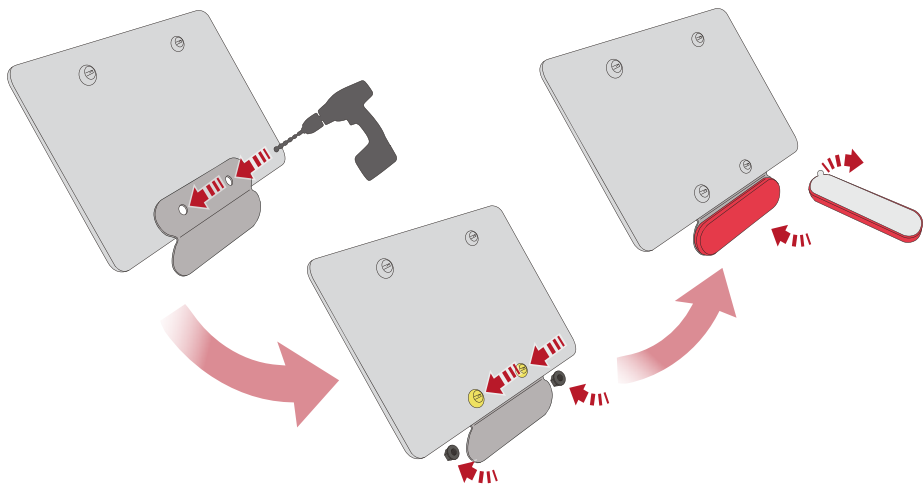

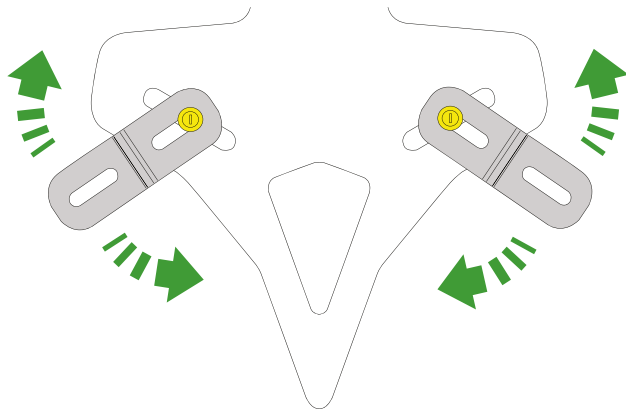



ESSENTIAL CHECKS

After installation of your tail tidy ensure that the licence plate does not contact the rear tyre when suspension is fully compressed.

Ensure all electrics including indicators, tail light, brake light and licence plate light lights are working correctly before riding the motorcycle.

It is recommended that periodic inspections are made to ensure that all fixings are fully tightend.



EVOTECH®
P E R F O R M A N C E

www.evotech-performance.com