

EVOTECH®
P E R F O R M A N C E

www.evotech-performance.com

Triumph Rocket
Beeline / Action Camera Mount



- Ⓐ 1 x M5 Silver Washer
- Ⓑ 1 x Pivot Plate
- Ⓒ 1 x Sub Mounting Bracket
- Ⓓ 1 x M5 x 20mm Caphead Bolts
- Ⓔ 2 x M5 x 8mm Caphead Bolts
- Ⓕ 2 x P-clips (No.1)
- Ⓖ 2 x P-clips (No.2)
- Ⓗ 2 x P-clips (No.3)
- Ⓘ 2 x P-clips (No.4)
- Ⓙ 2 x M5 Black Washer
- Ⓚ 2 x Lobe Screw
- Ⓛ 2 x Locking Washer
- Ⓜ 2 x M4 x 5mm Black Button Head Bolts
- ⒶⒶ 2 x M5 x 16mm Flange Bolt
- ⒷⒷ 1 x M5 x 20mm Flange Bolt

EATON PERFORMANCE

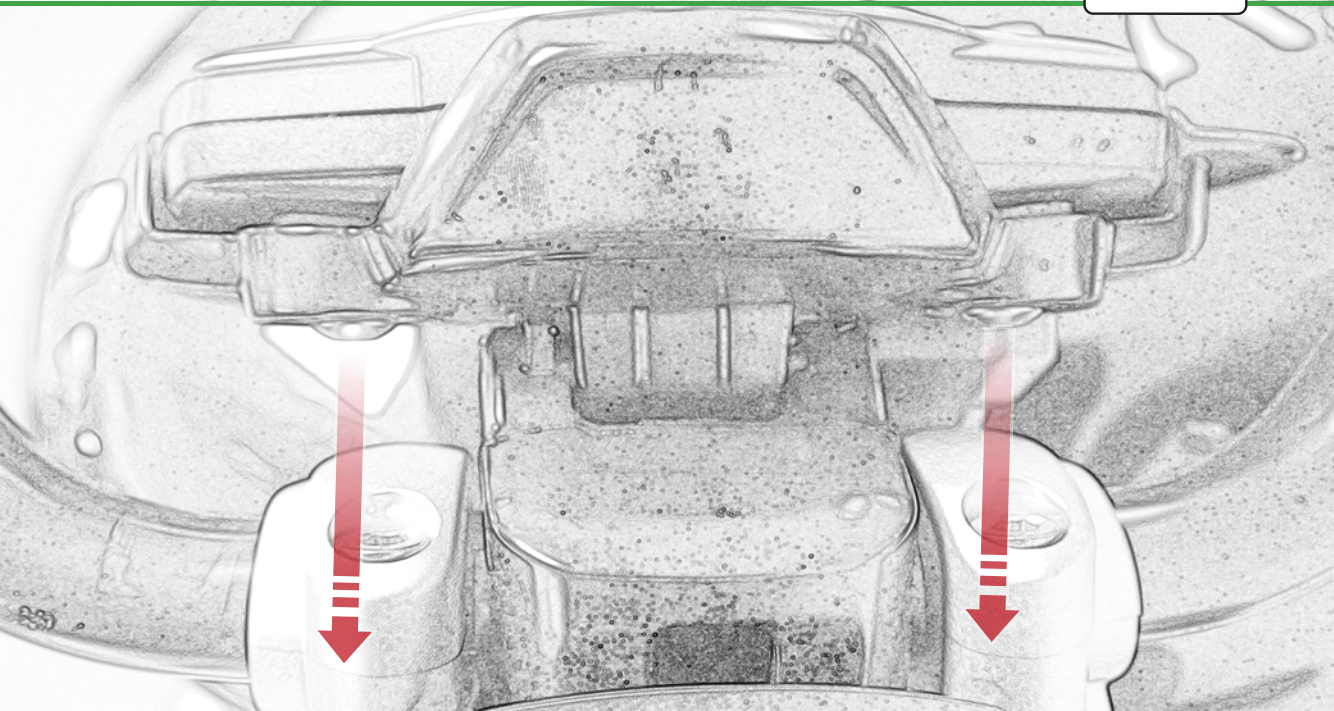

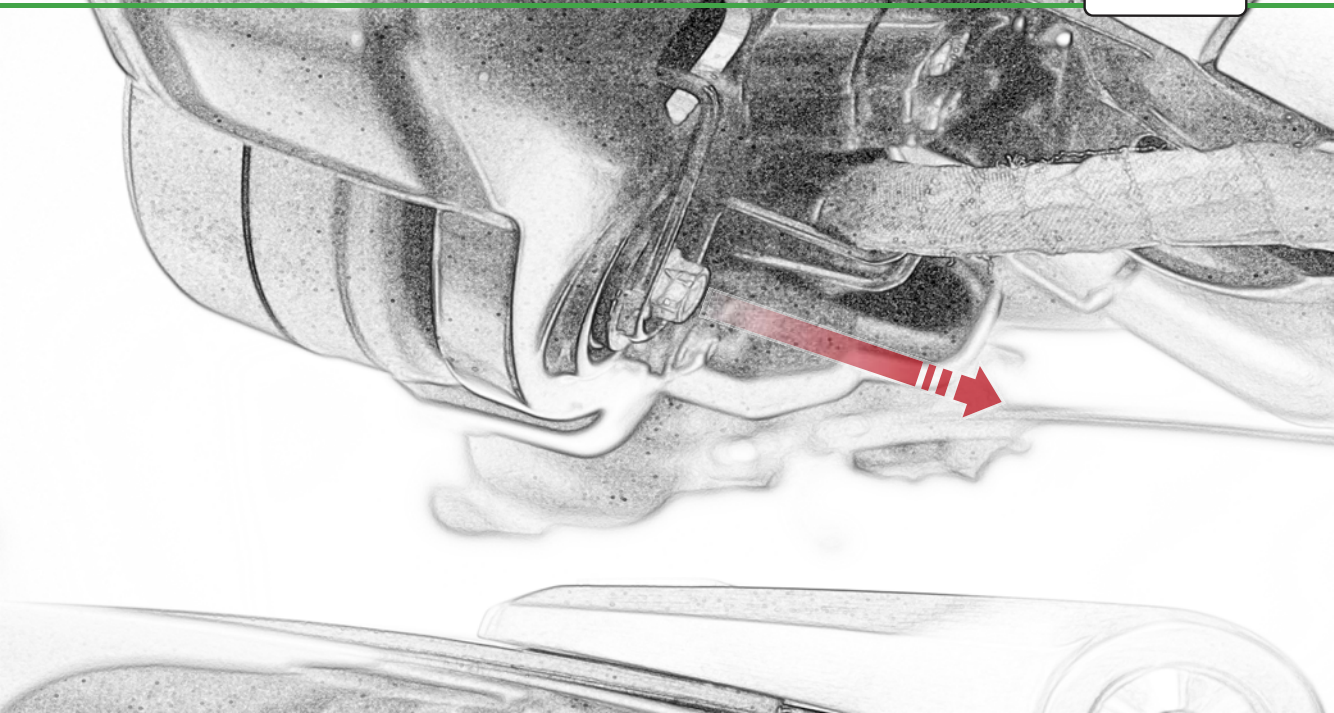

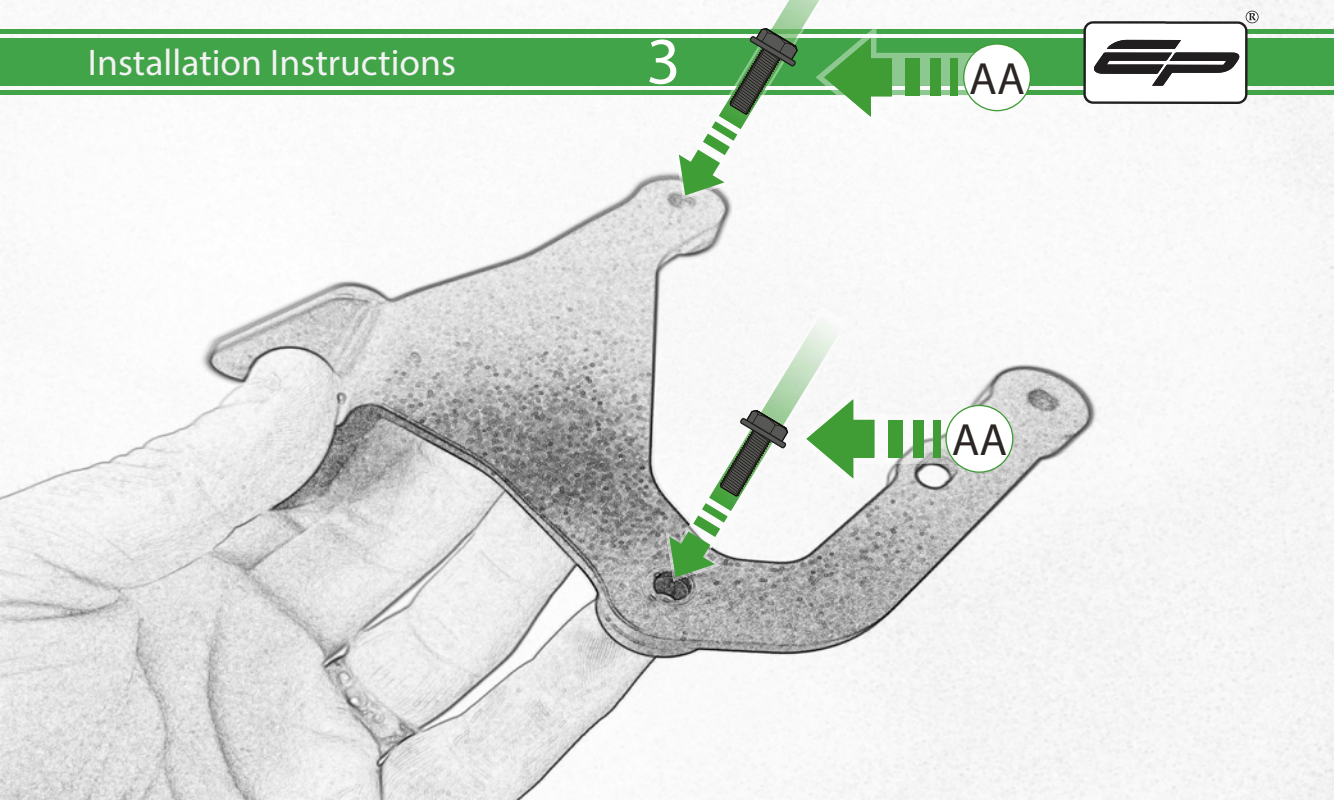

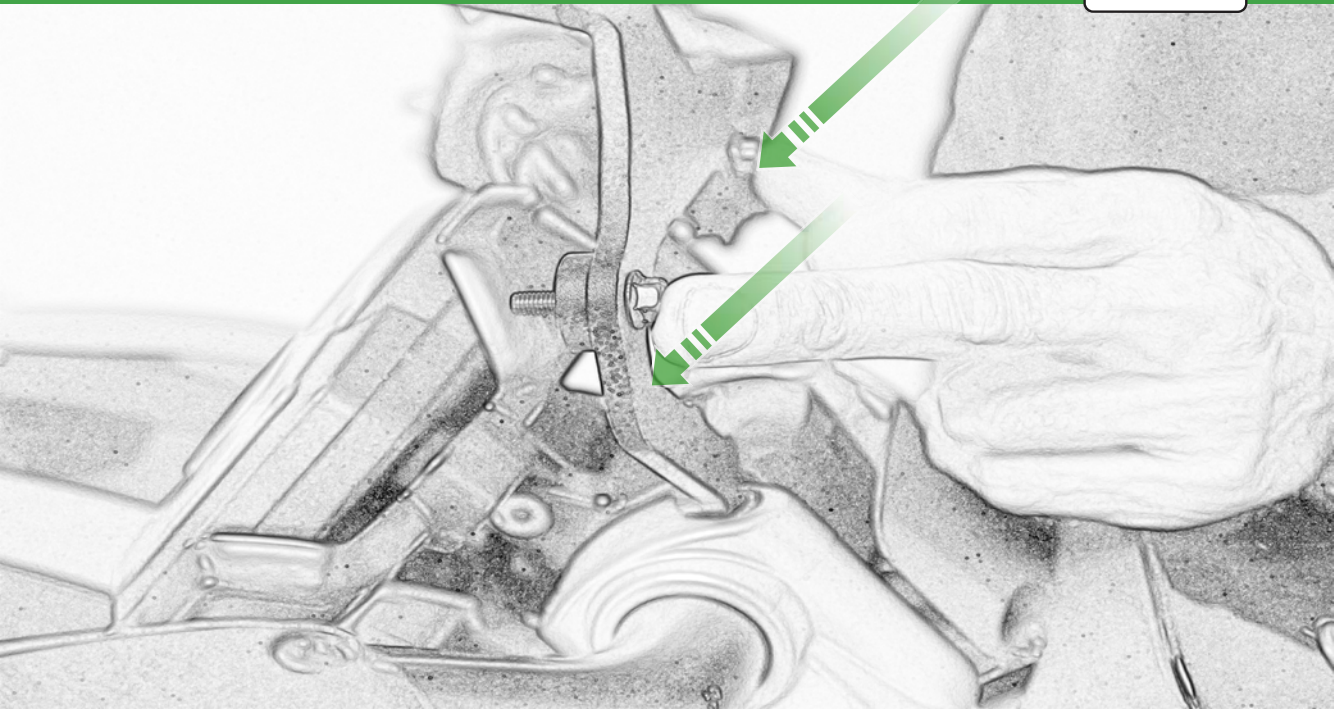

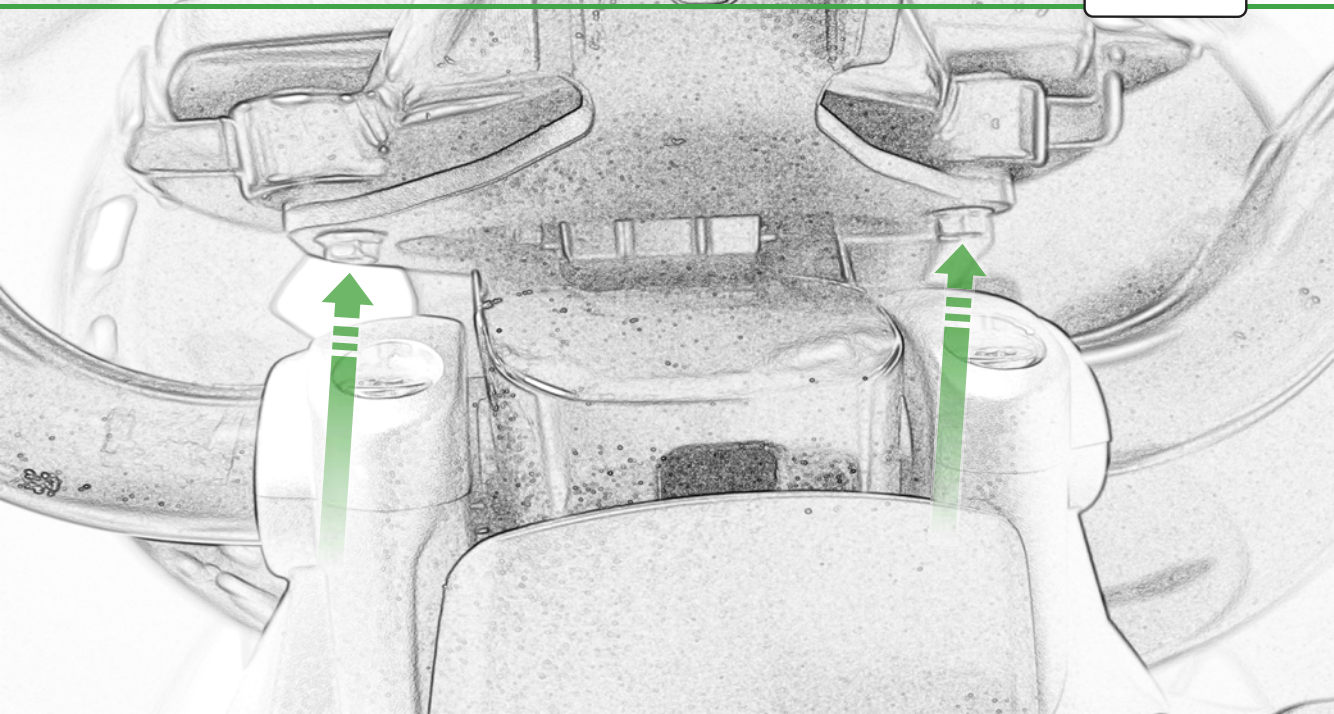

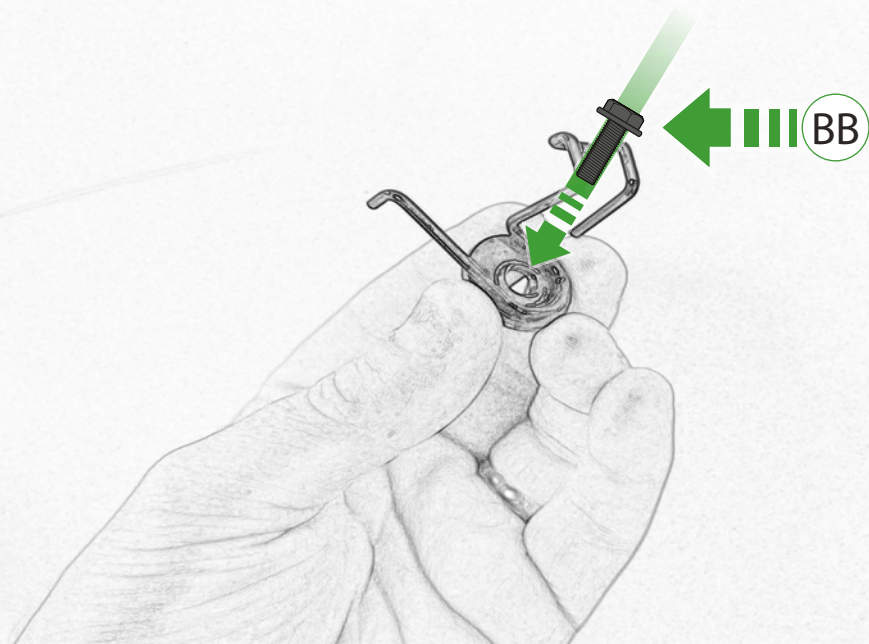

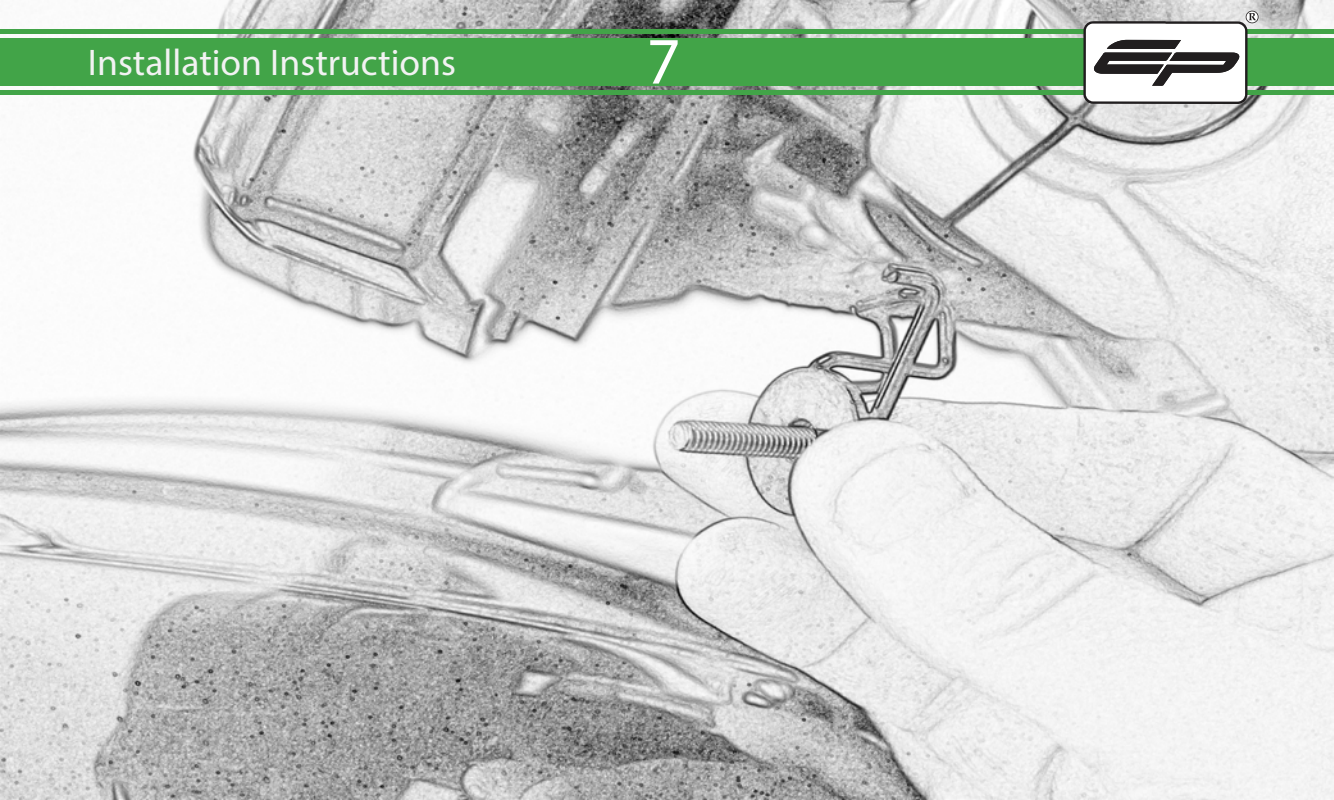

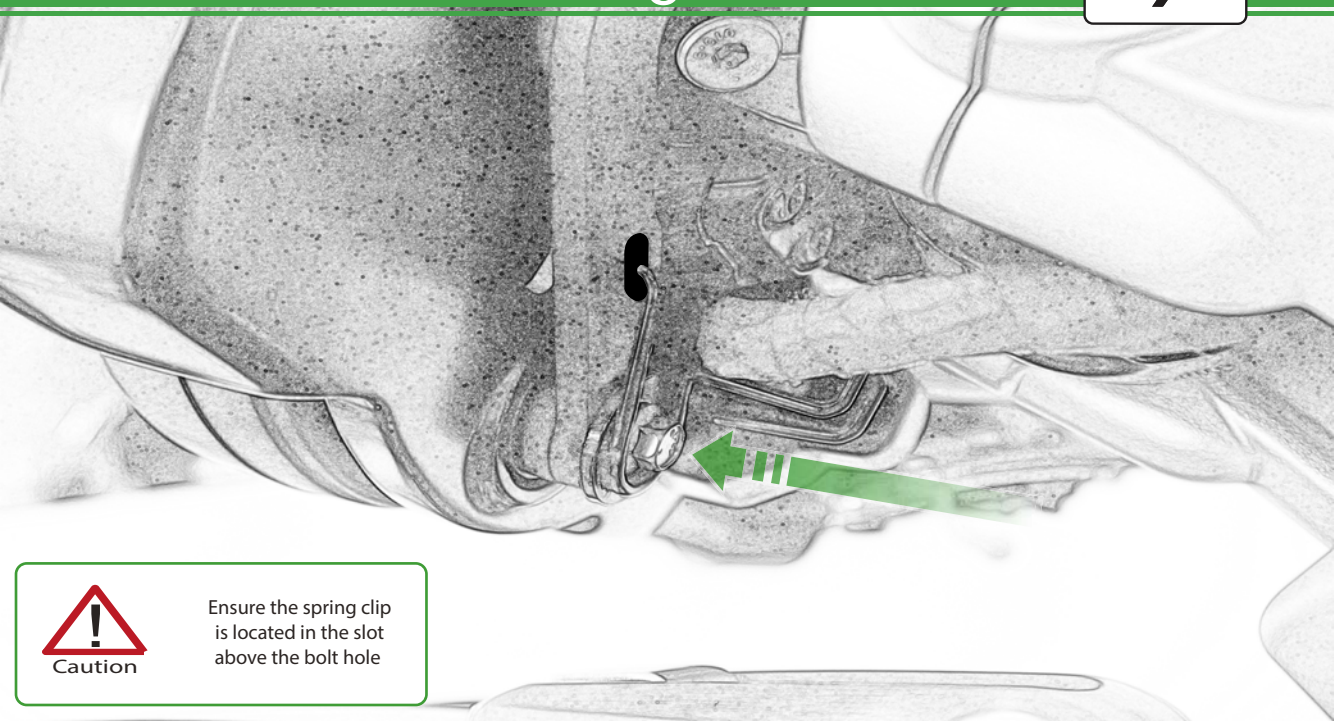

Caution

Ensure the spring clip
is located in the slot
above the bolt hole

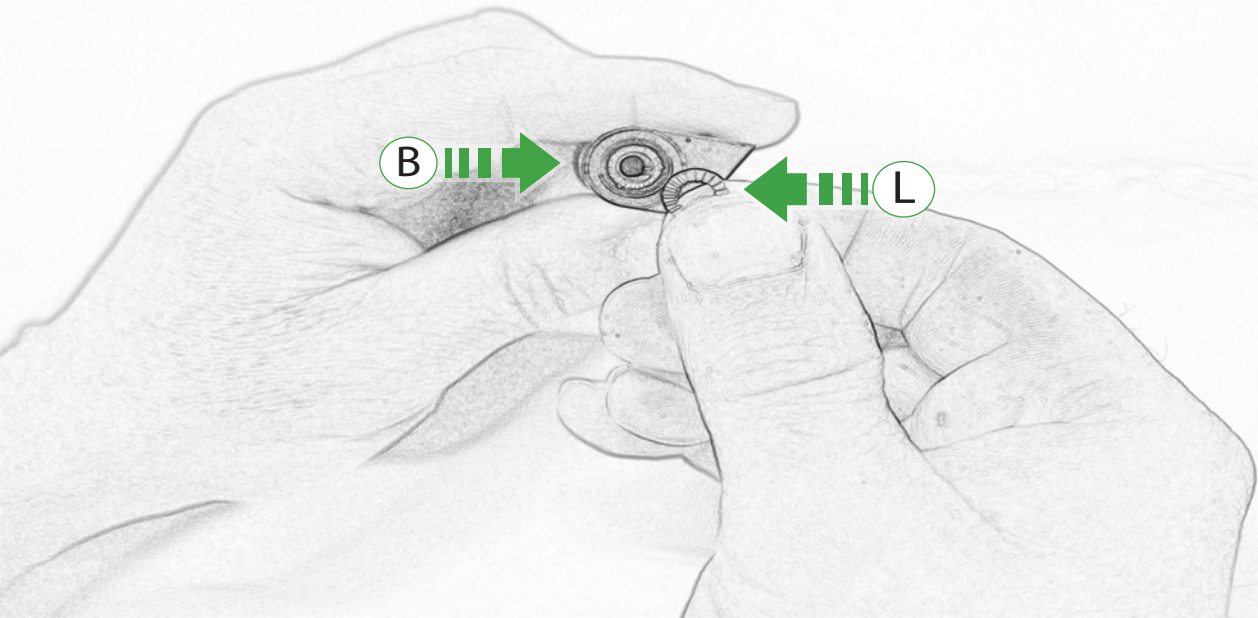

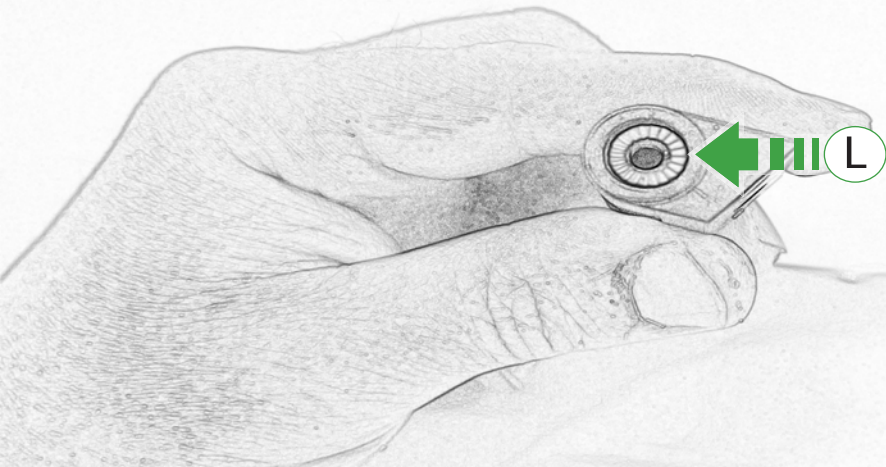

Repeat
Both Sides

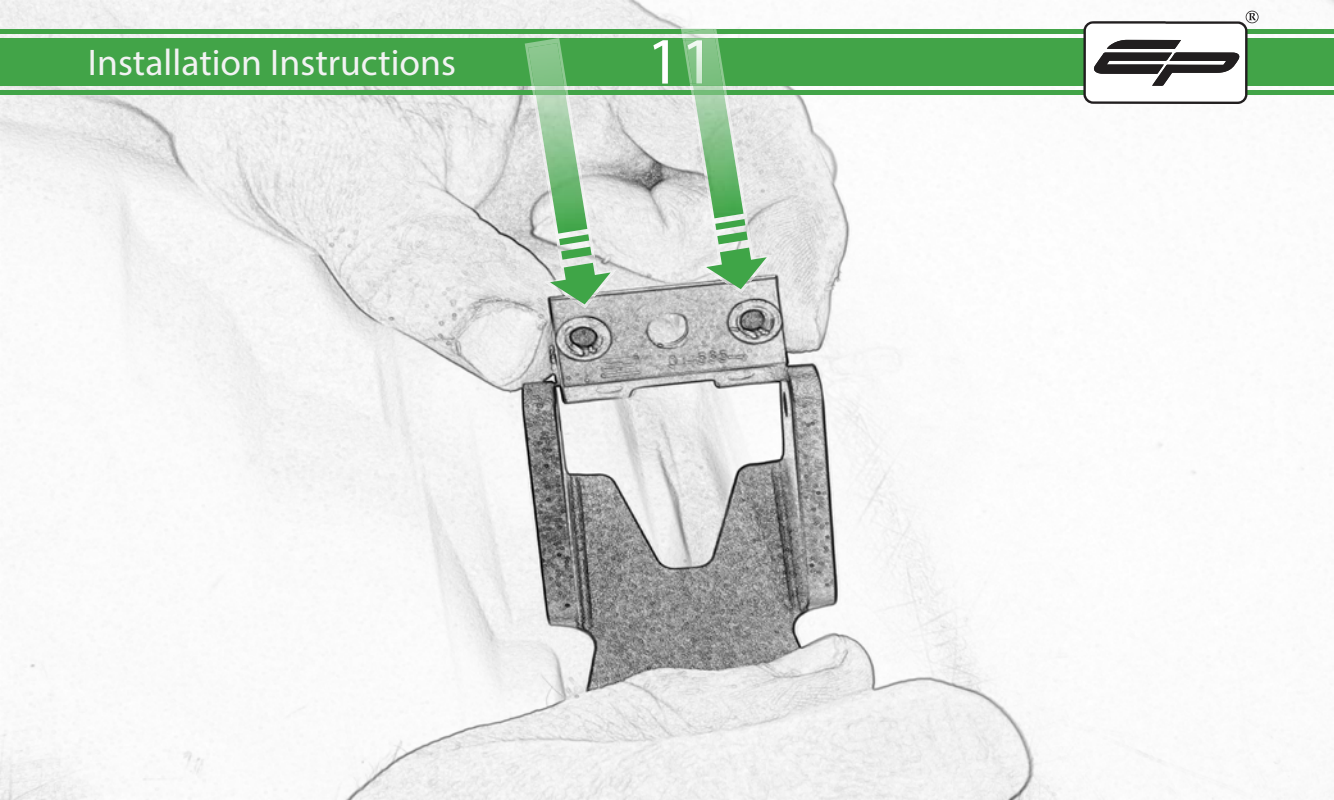

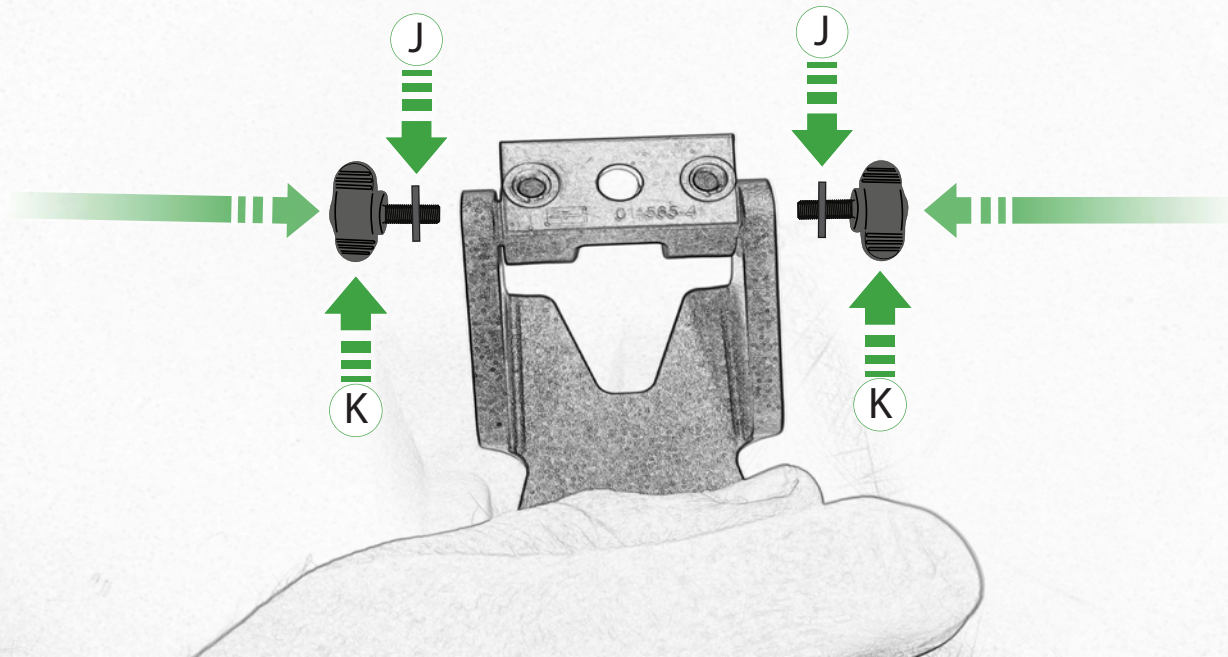

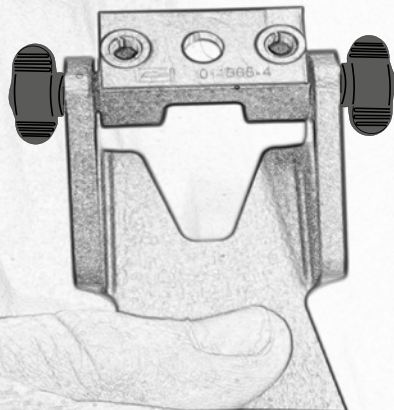
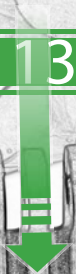

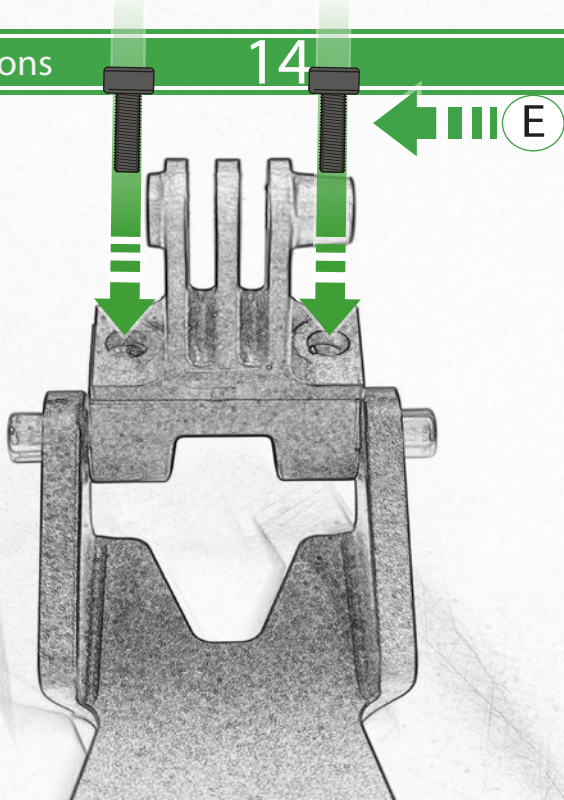

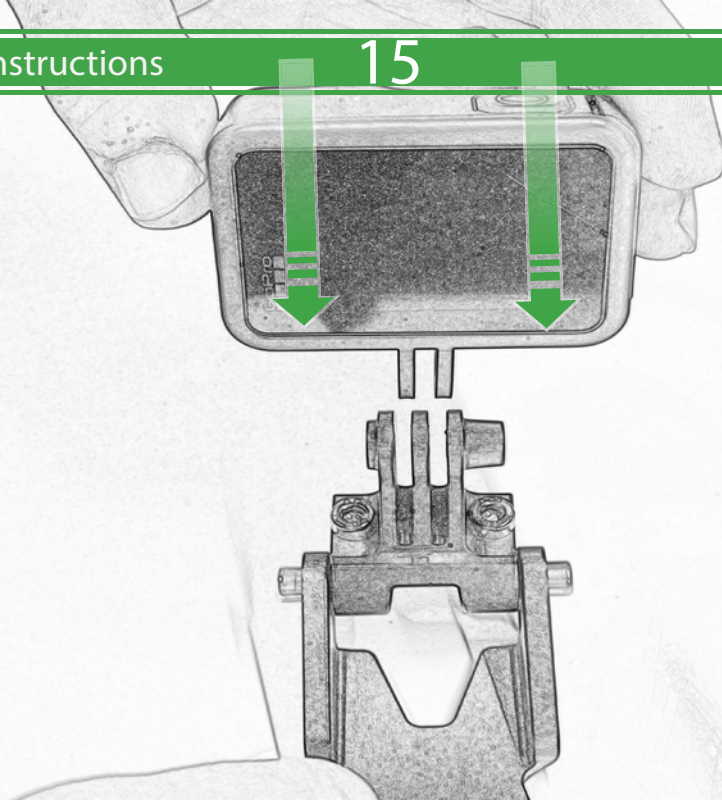

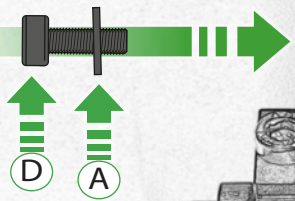
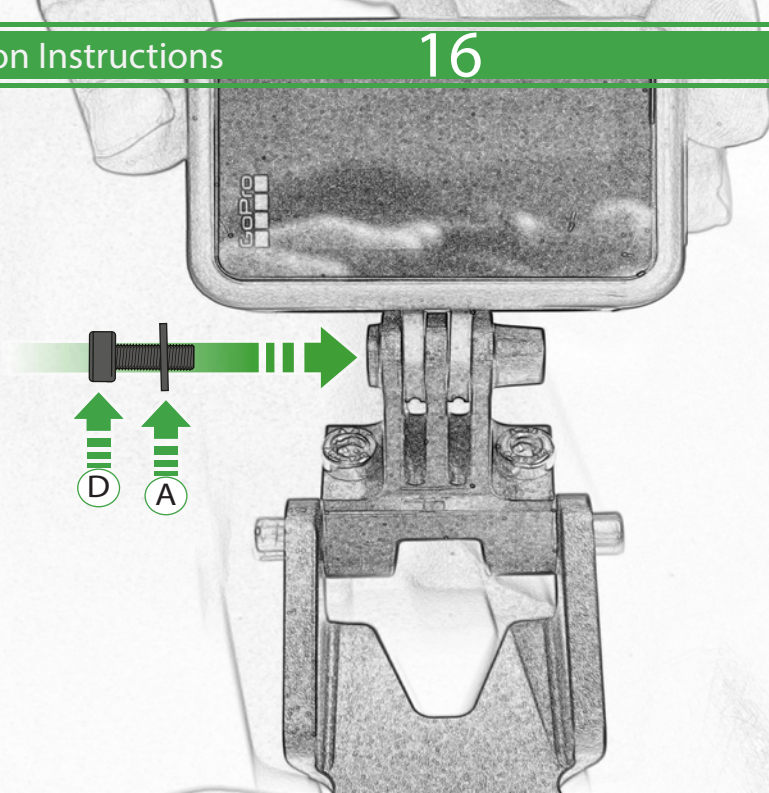



 **ESSENTIAL CHECKS**  [®]

It is recommended that periodic inspections are made to ensure that all bolts are tightened to the specified torque settings.

Some smartphone models may also require an anti-vibration mount or dampener to further reduce vibration and help with image stabilisation.

It is the rider's responsibility to ensure that this is fitted correctly before use.

P E R F O R M A N C E [®]



EVOTECH®
P E R F O R M A N C E

www.evotech-performance.com