

EVOTECH®
P E R F O R M A N C E

www.evotech-performance.com

Kawasaki ZX10R Tail Tidy Instructions

Installation Instructions



Kit Contents PRN015459

- (A) 1 x Retro Light
- (B) 1 x Loom Connector Type 19
- (C) 2 x Indicator Pod
- (D) 2 x M4 x 16 Black Button Heads
- (E) 2 x M4 Flange Nuts
- (F) 4 x M6 x 20 Black Button Heads
- (G) 4 x M3 x 10 Black Button Heads

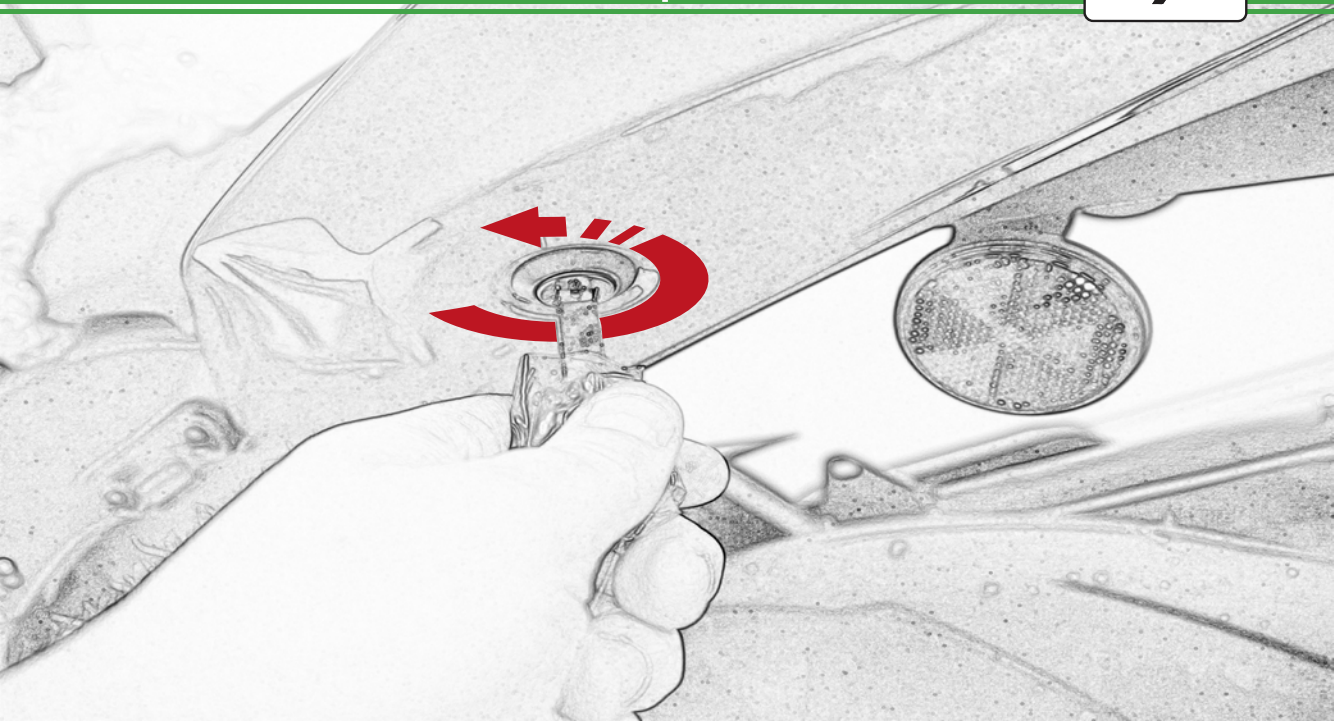

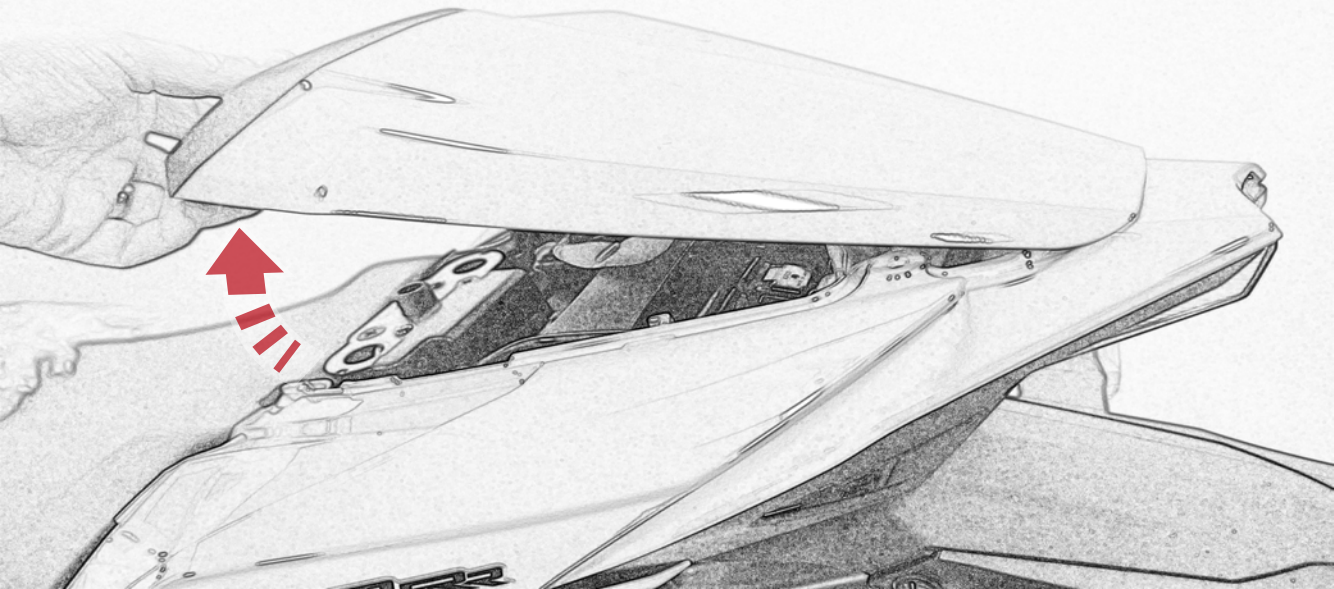

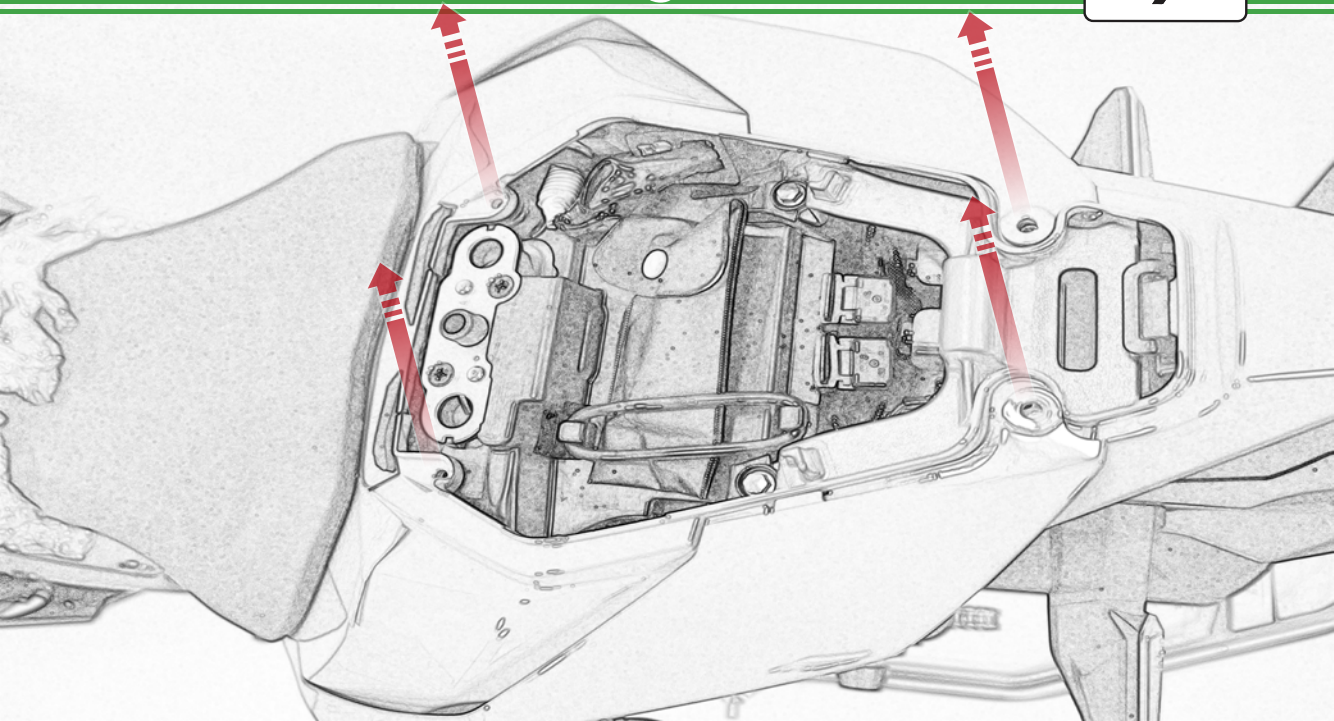

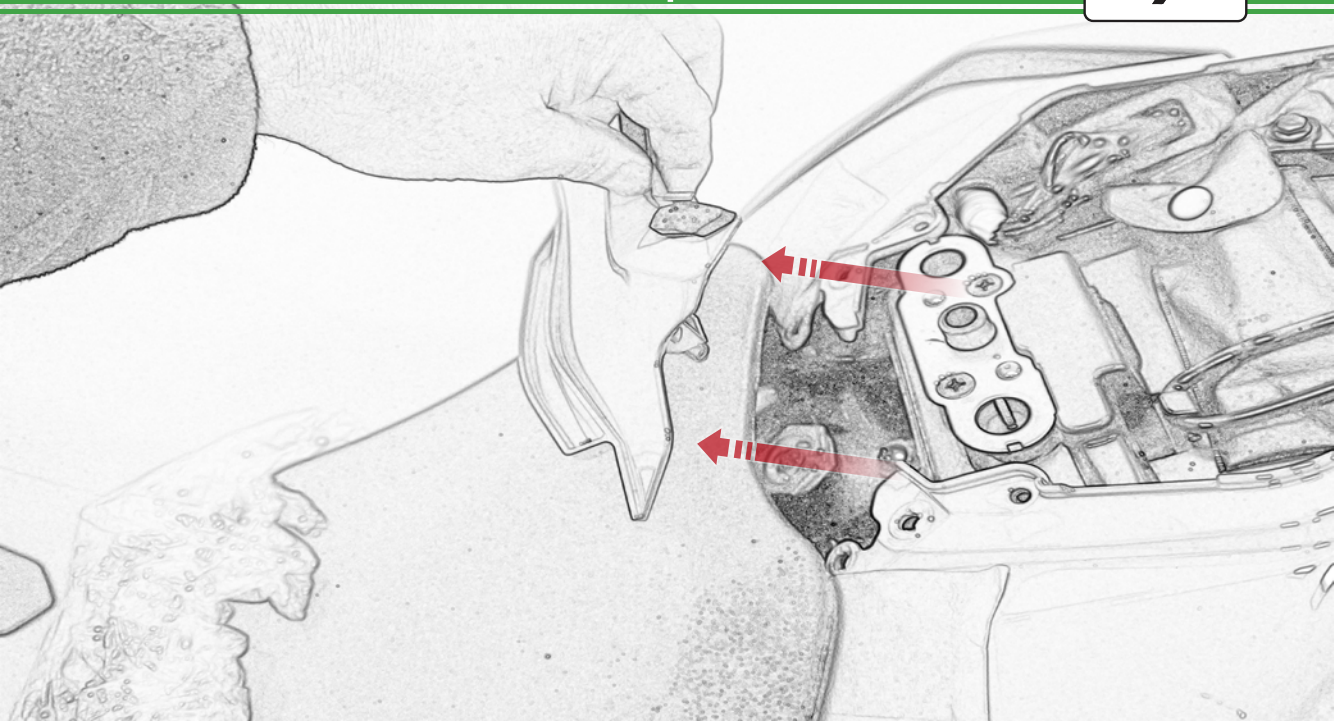

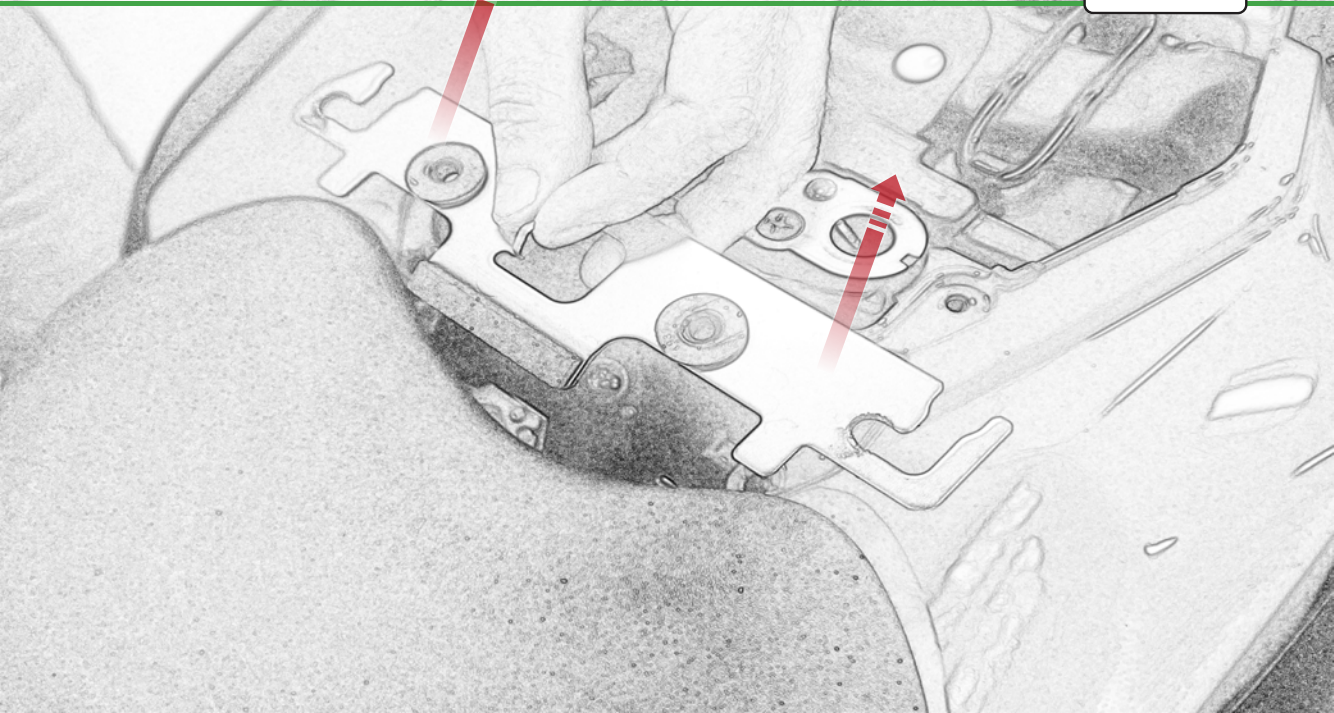

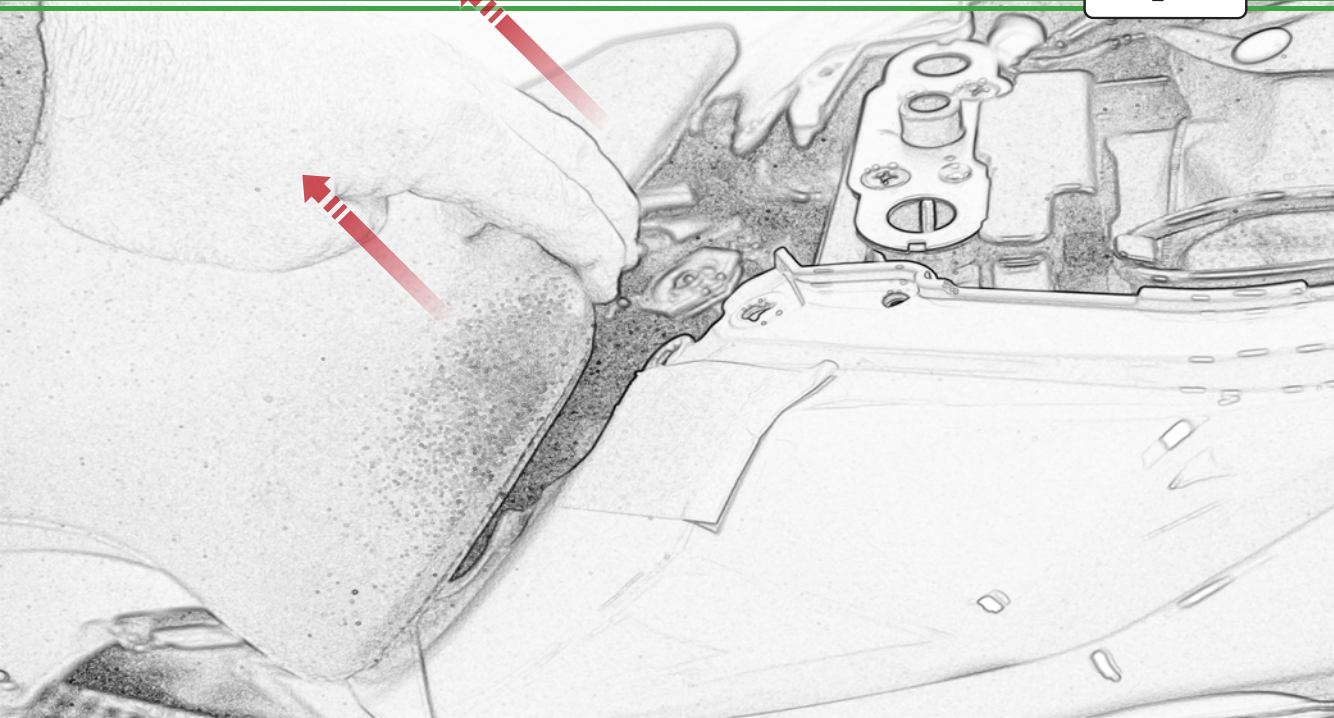

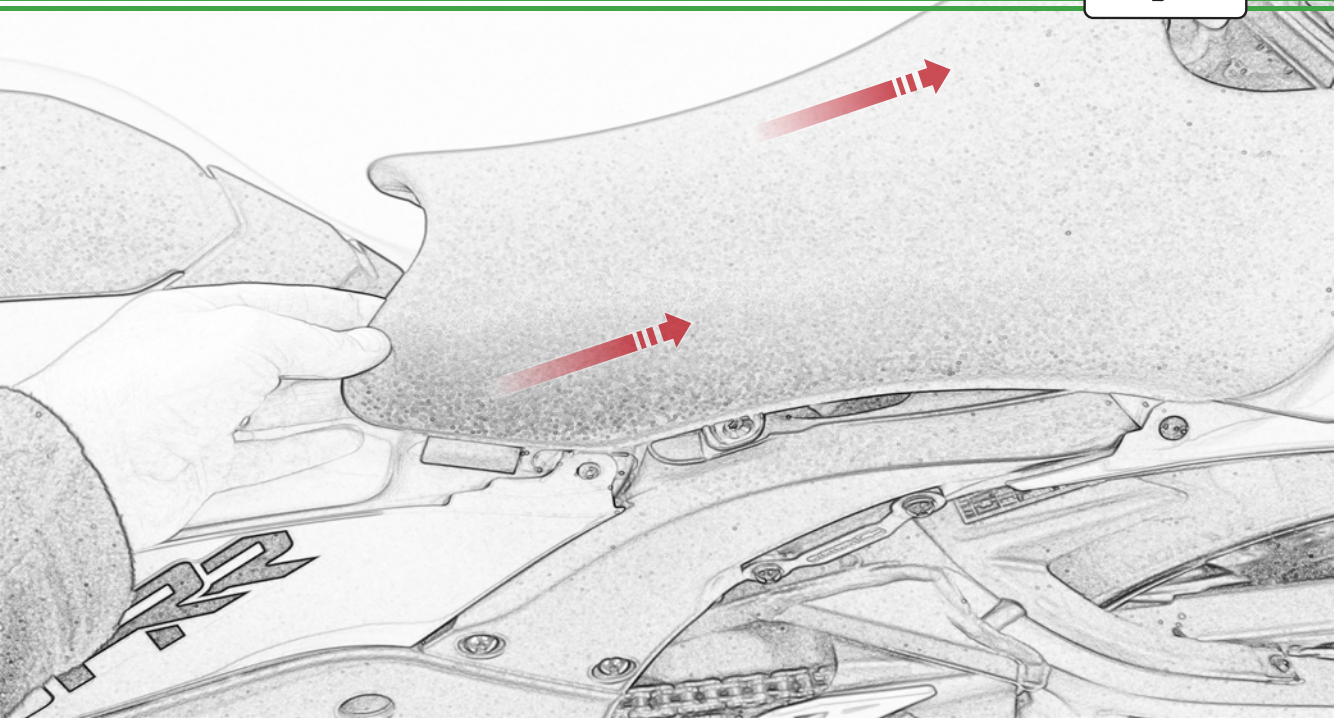

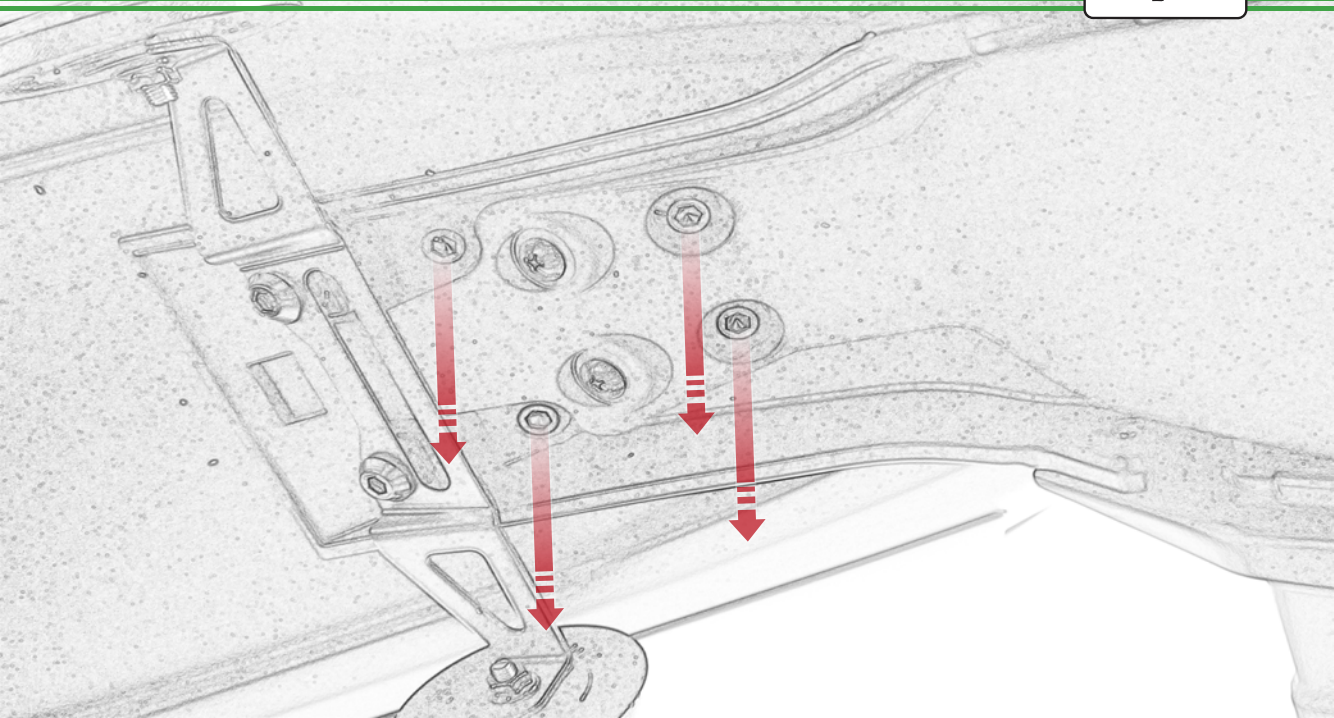

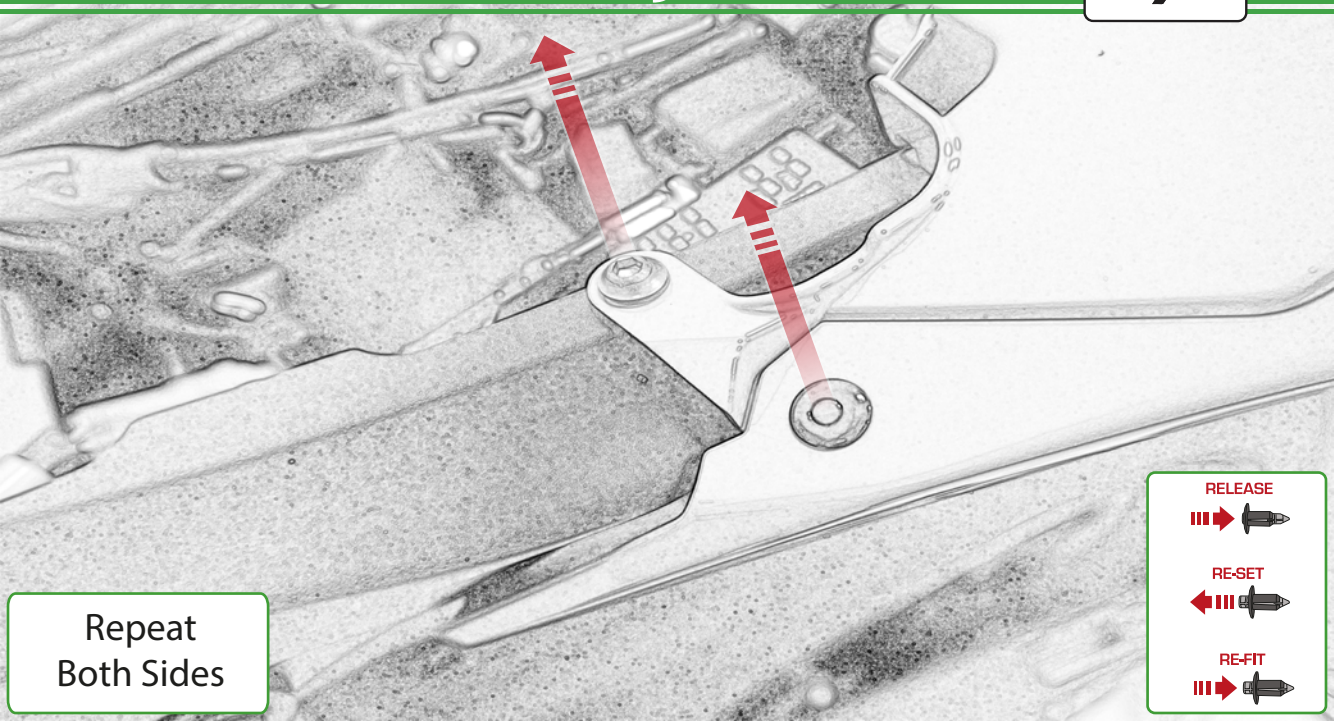







Repeat
Both Sides

RELEASE
 

RE-SET
 

RE-FIT
 

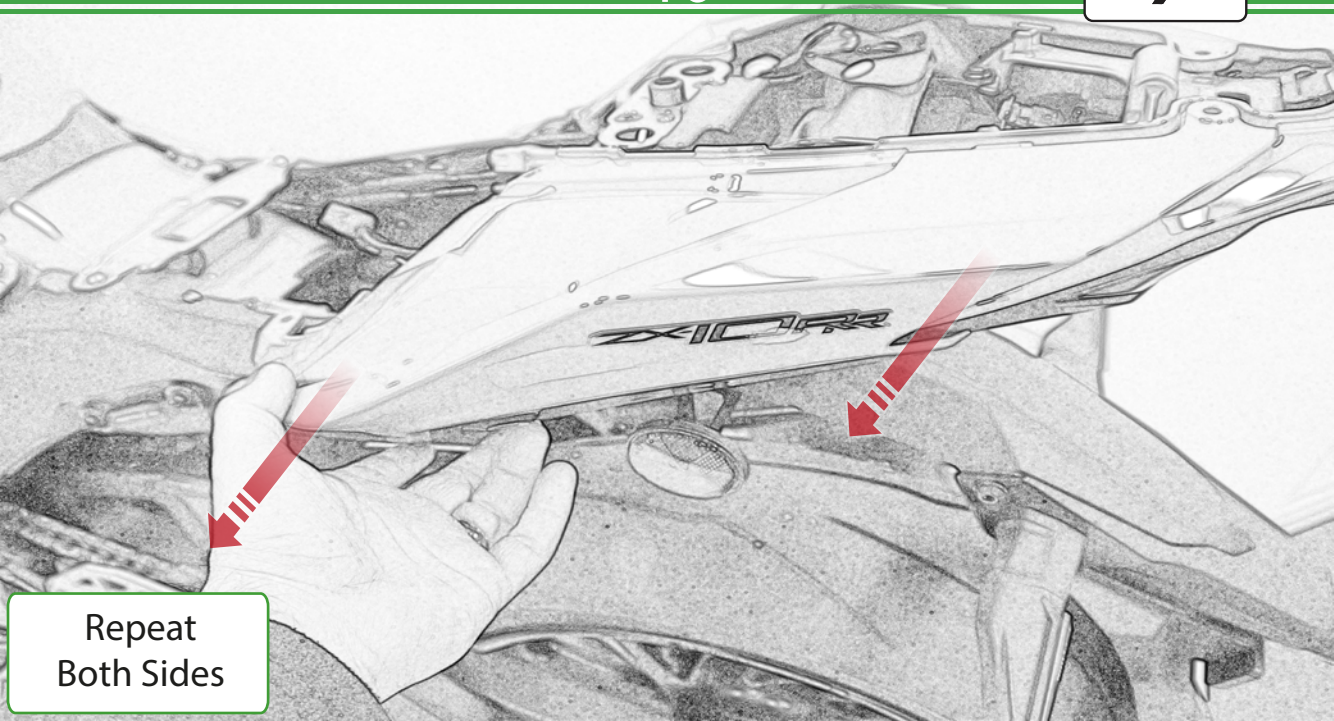

Repeat
Both Sides

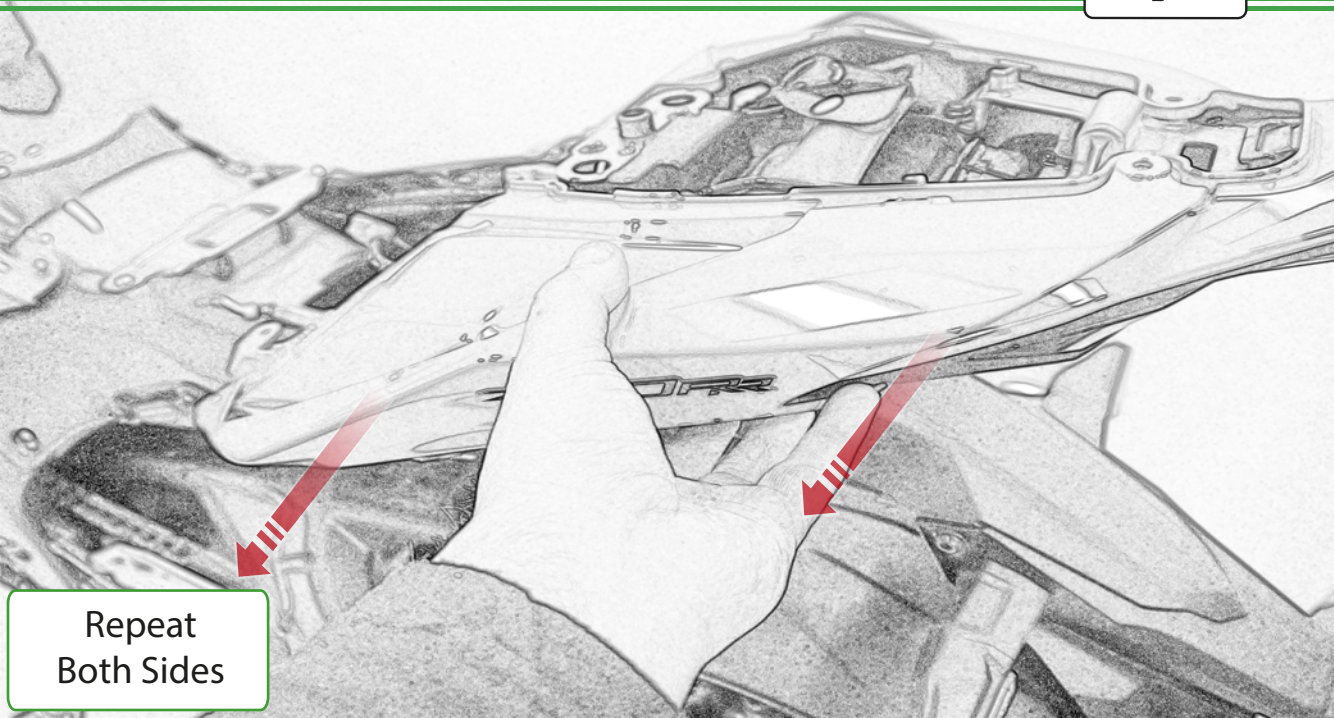

Repeat
Both Sides

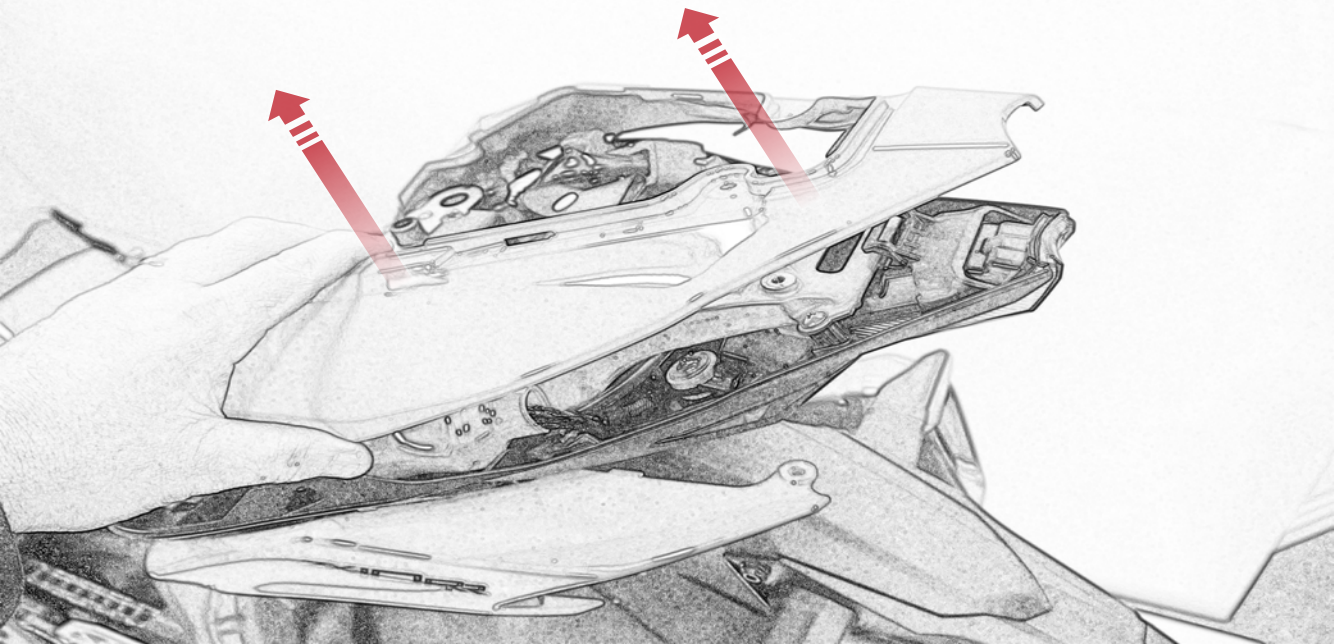

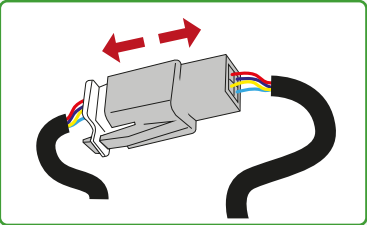
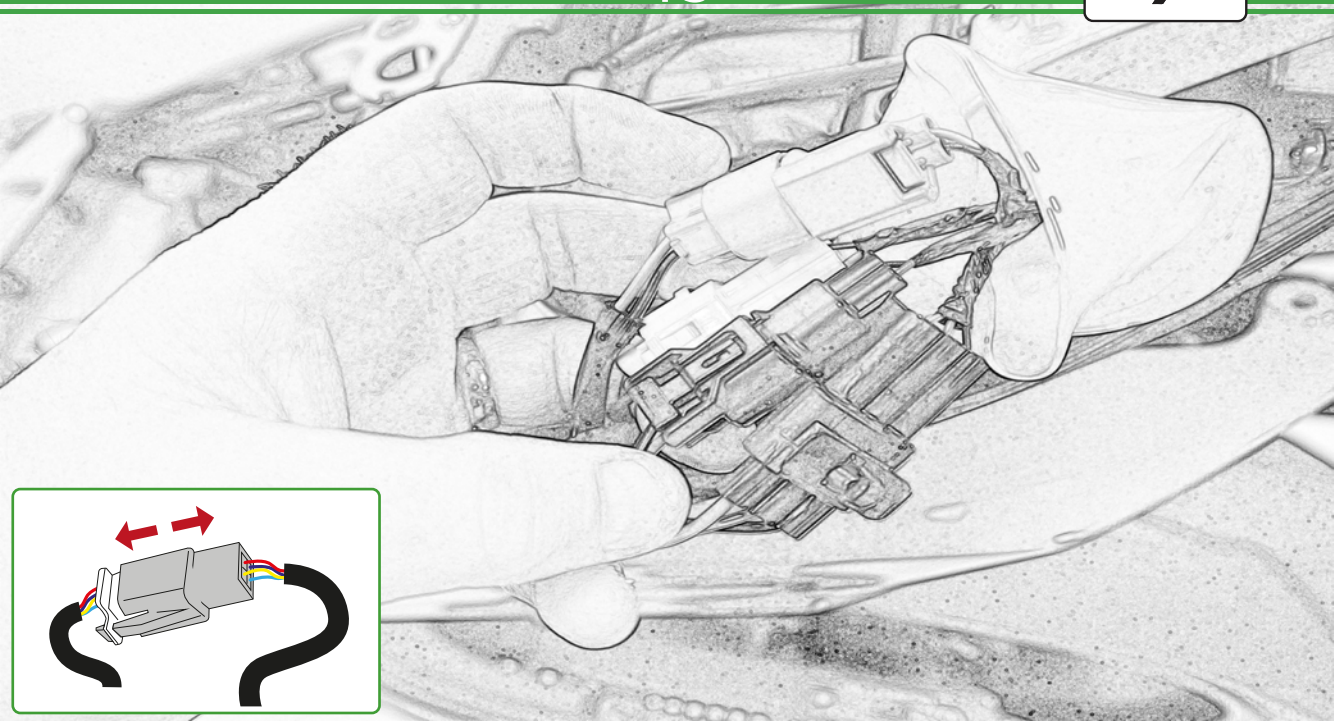

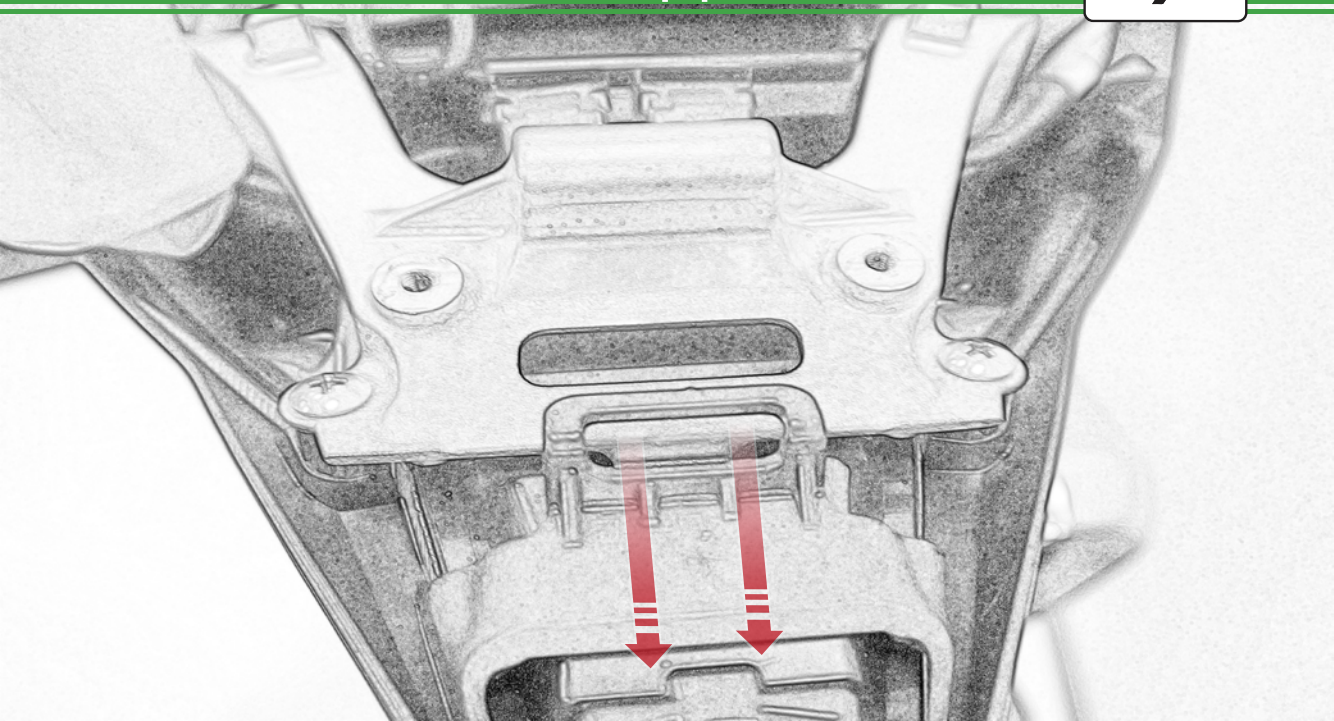

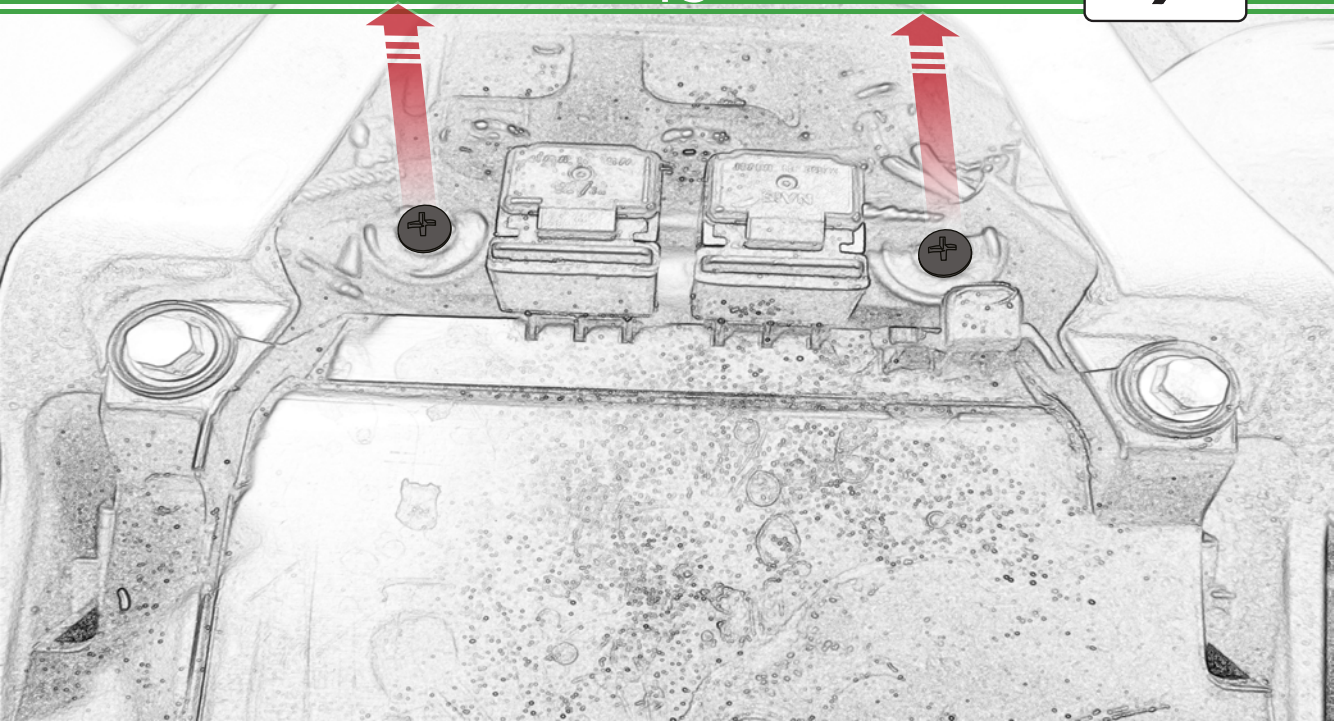

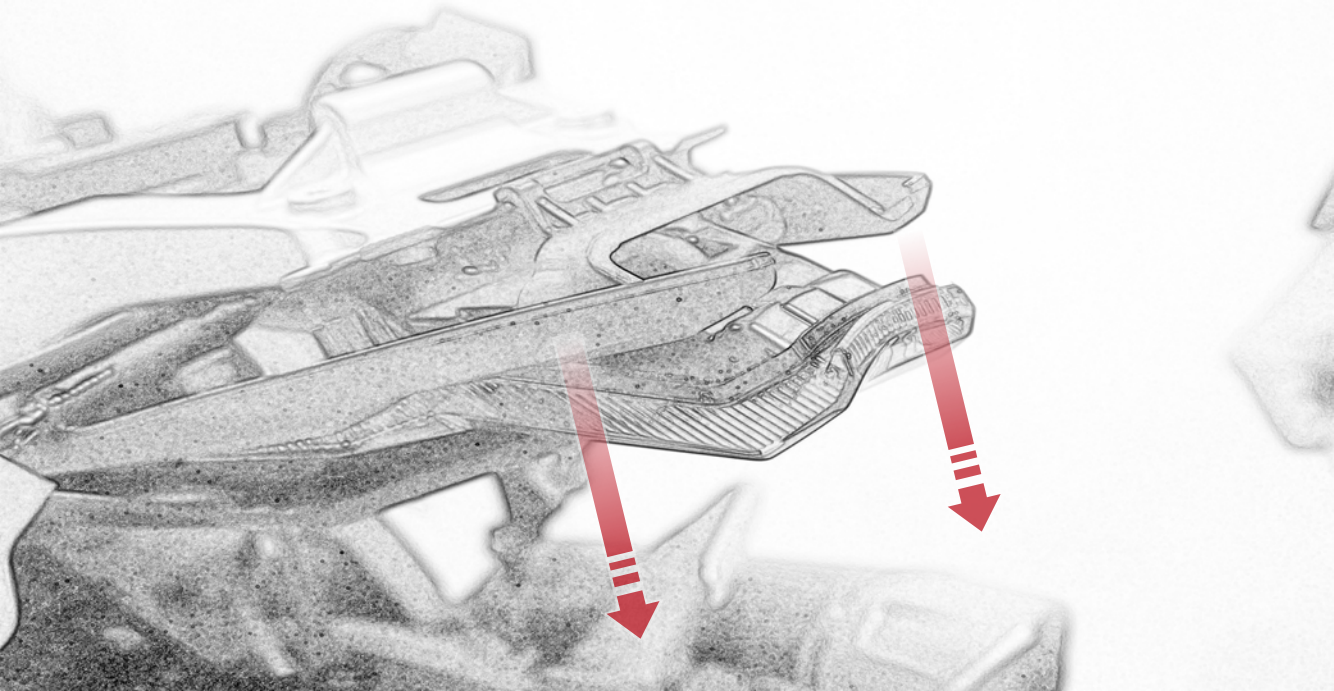



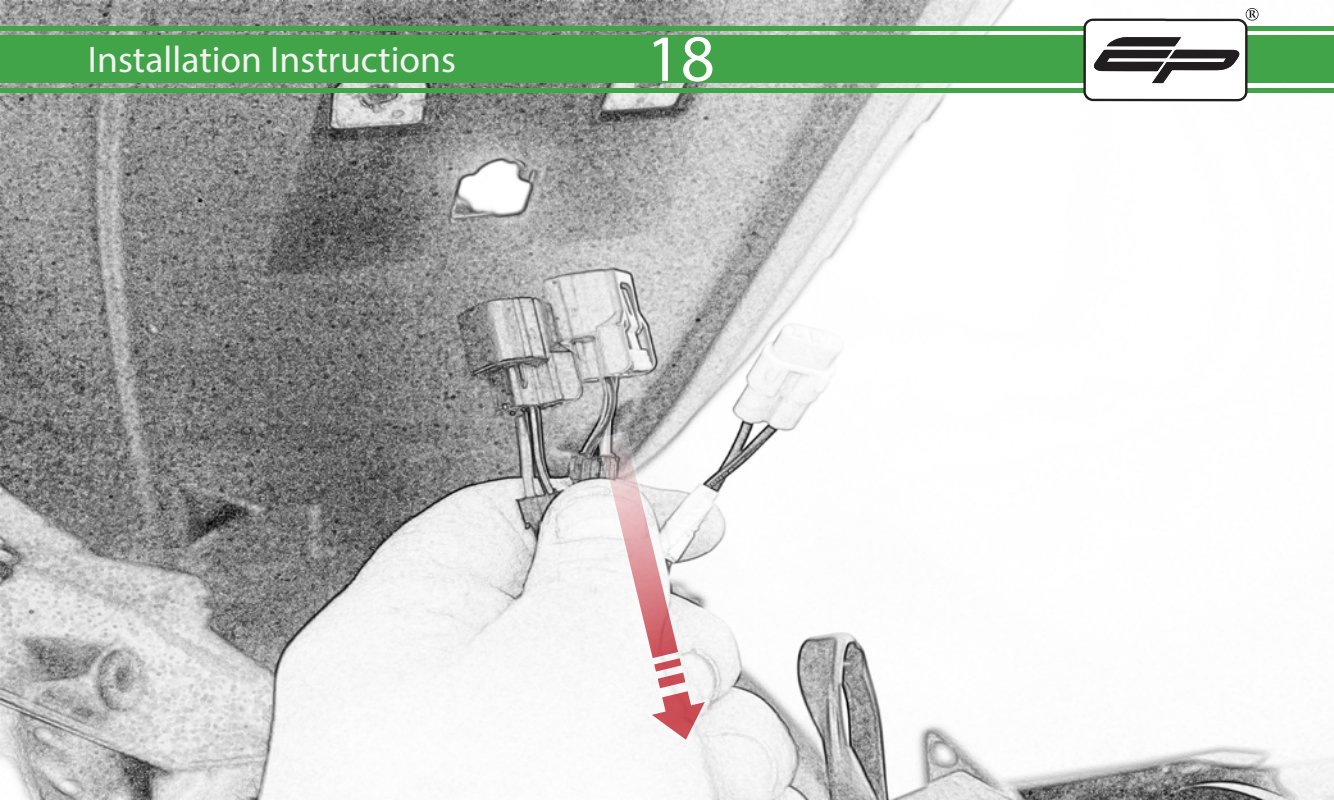

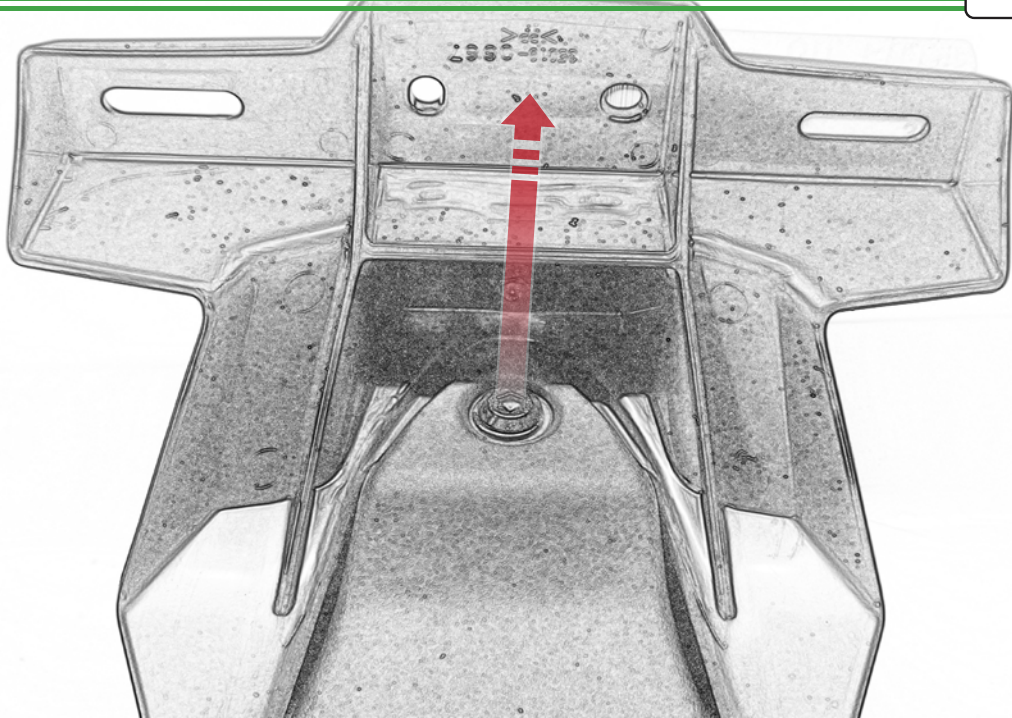

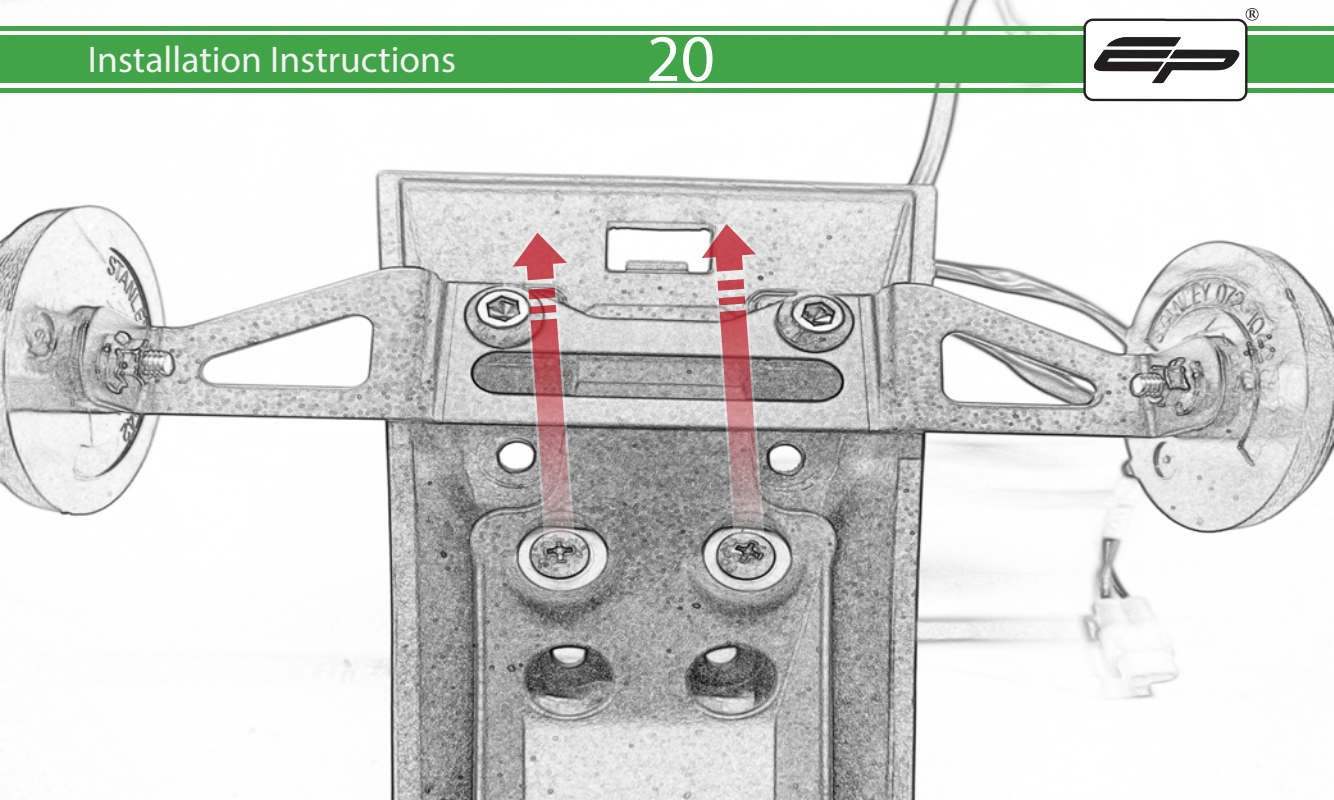

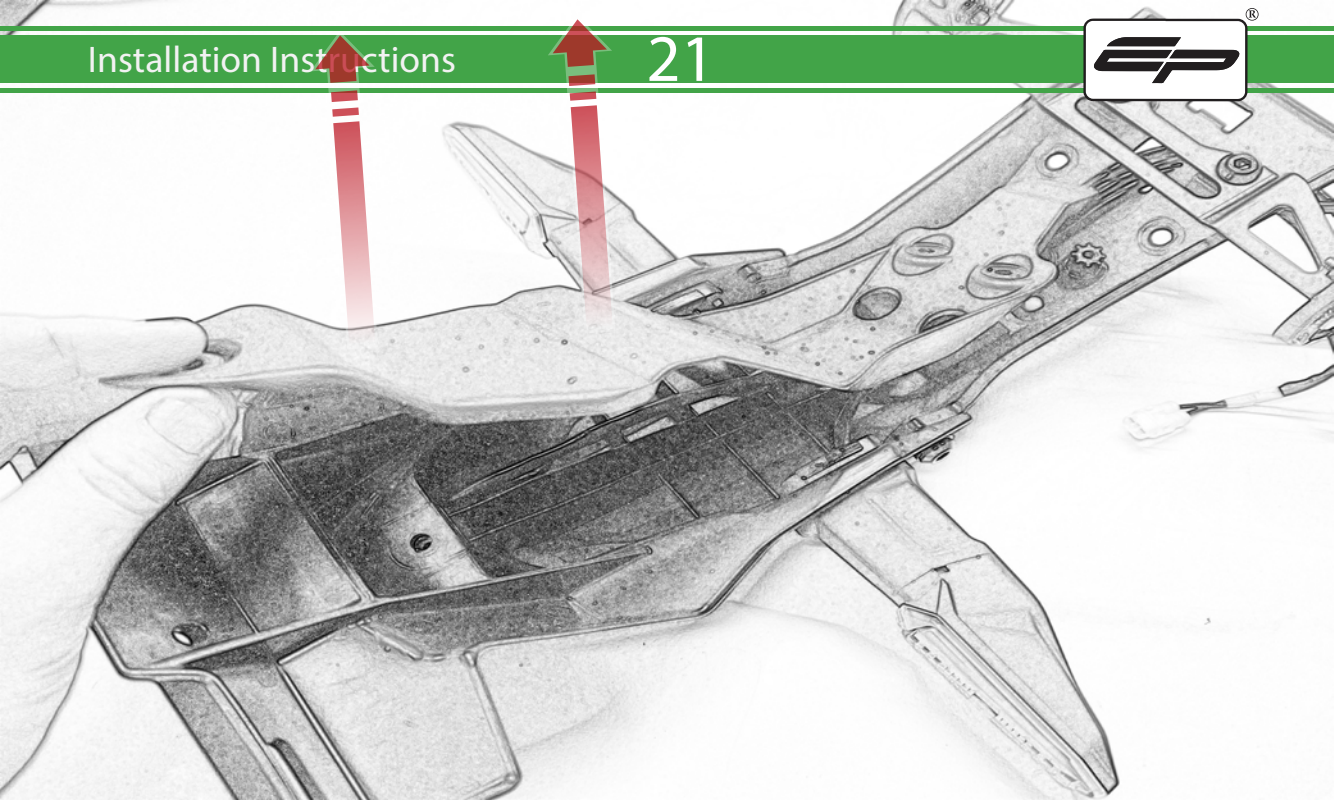

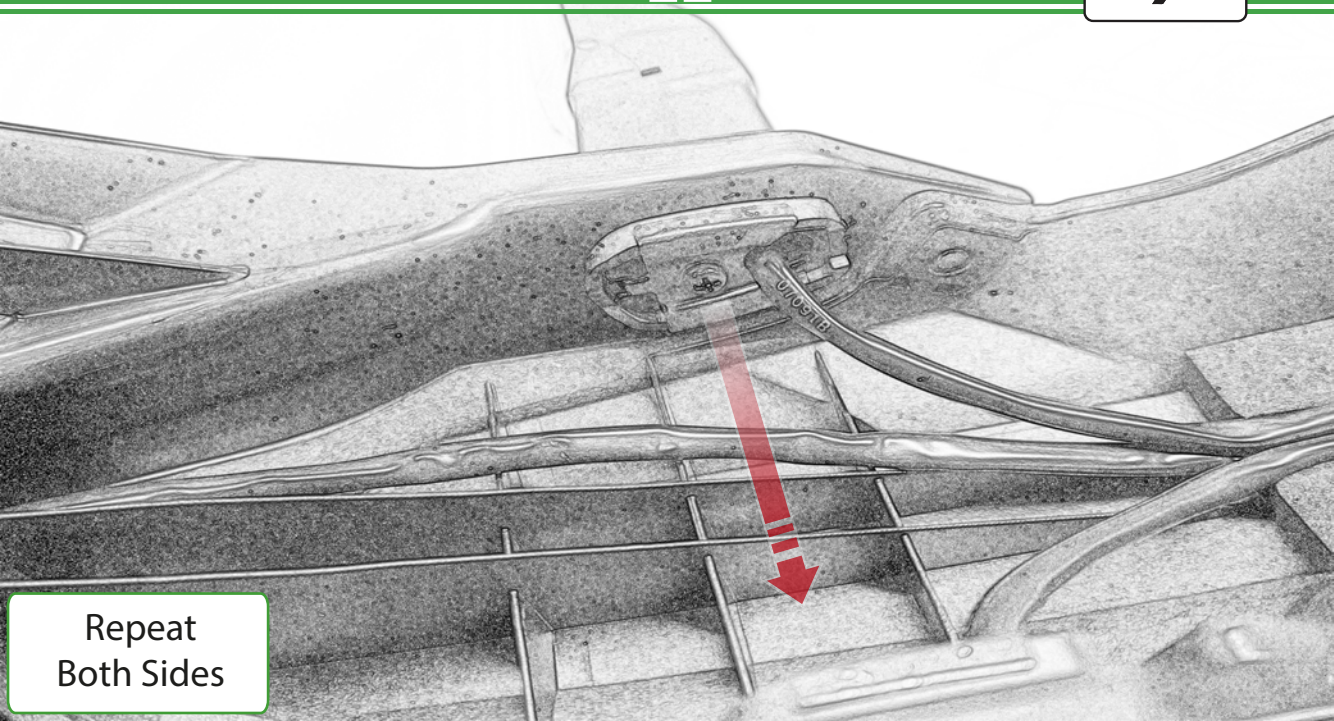

Repeat
Both Sides

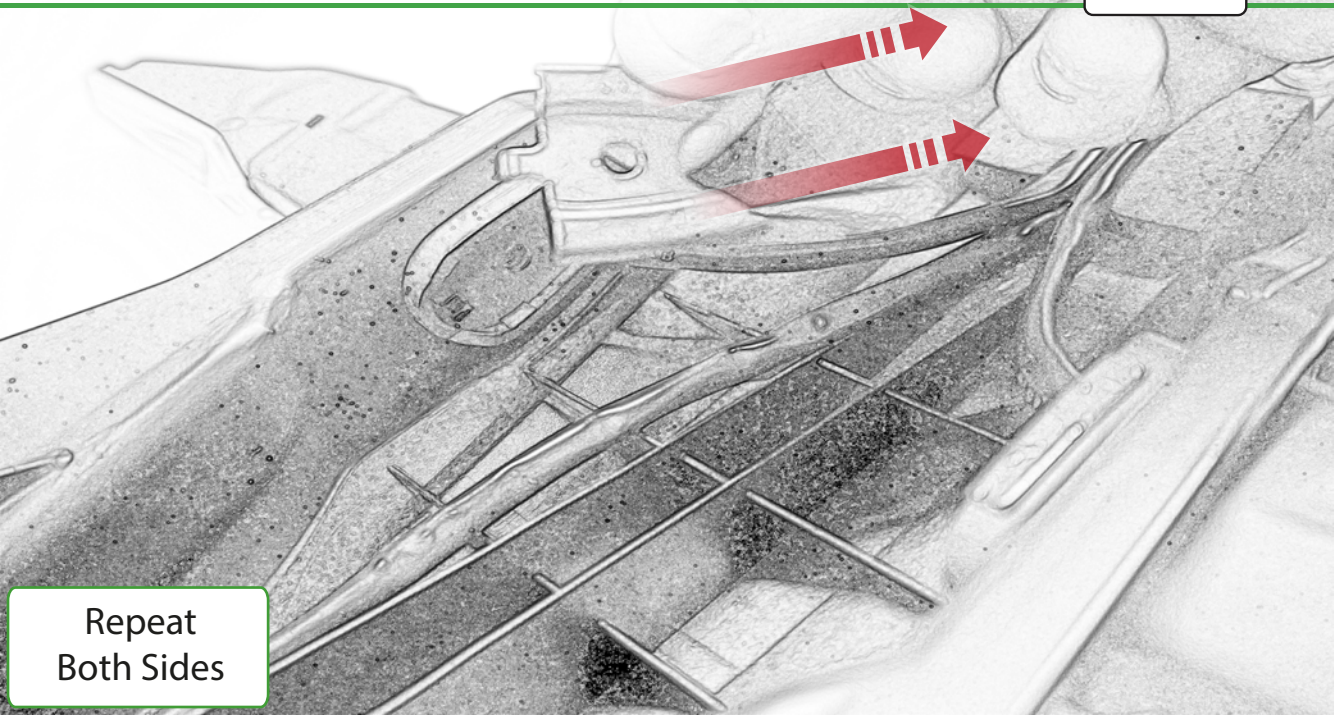

Repeat
Both Sides

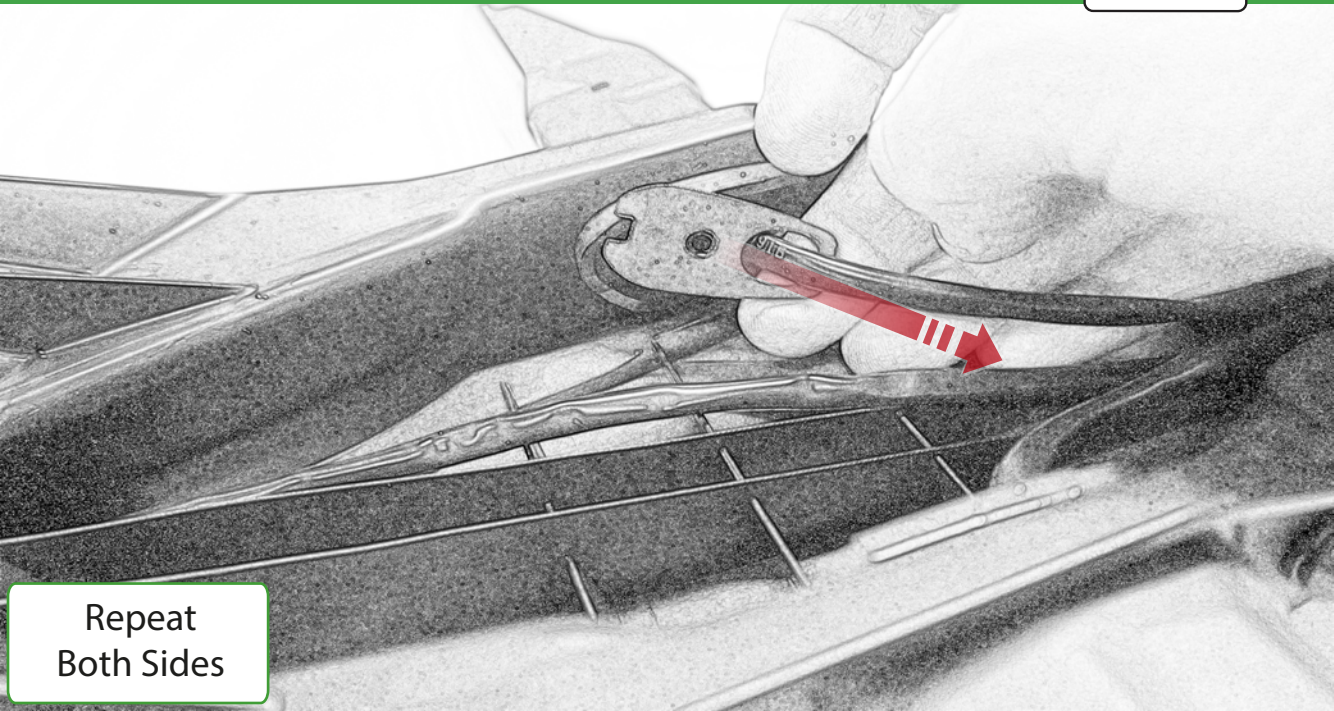

Repeat
Both Sides

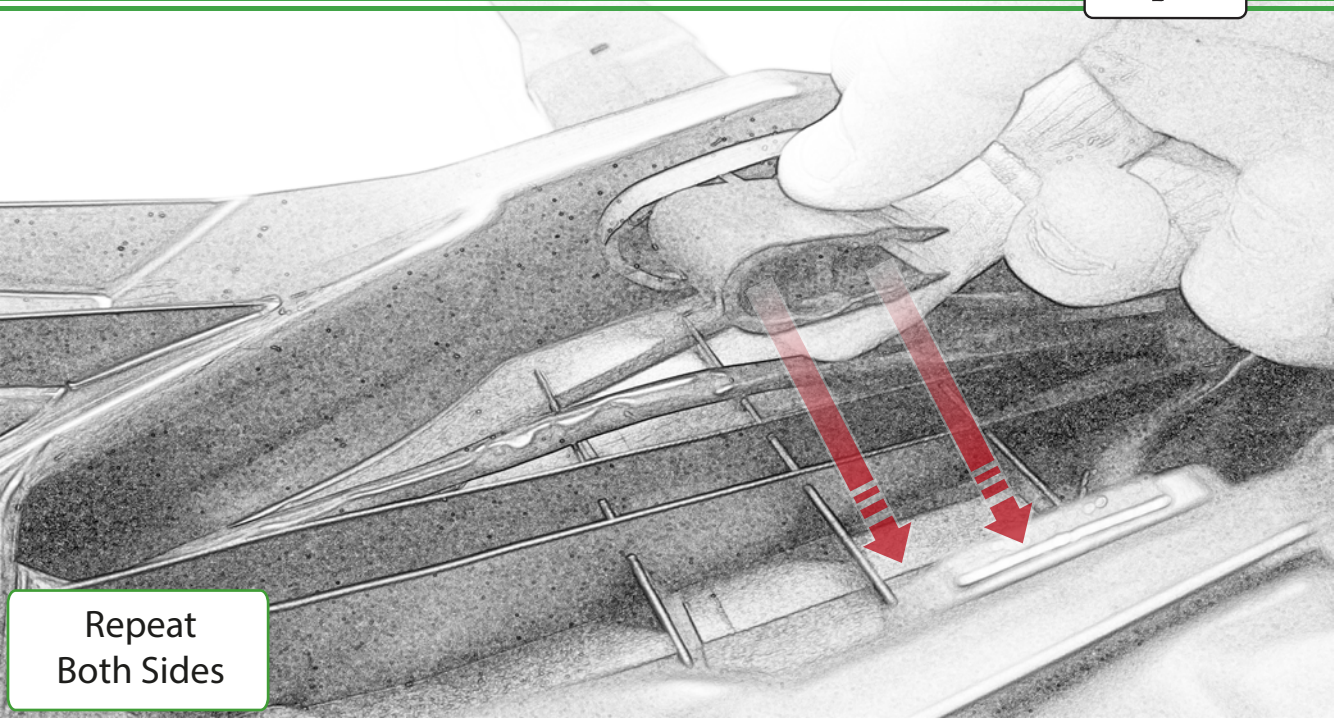

Repeat
Both Sides

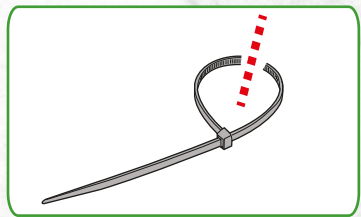
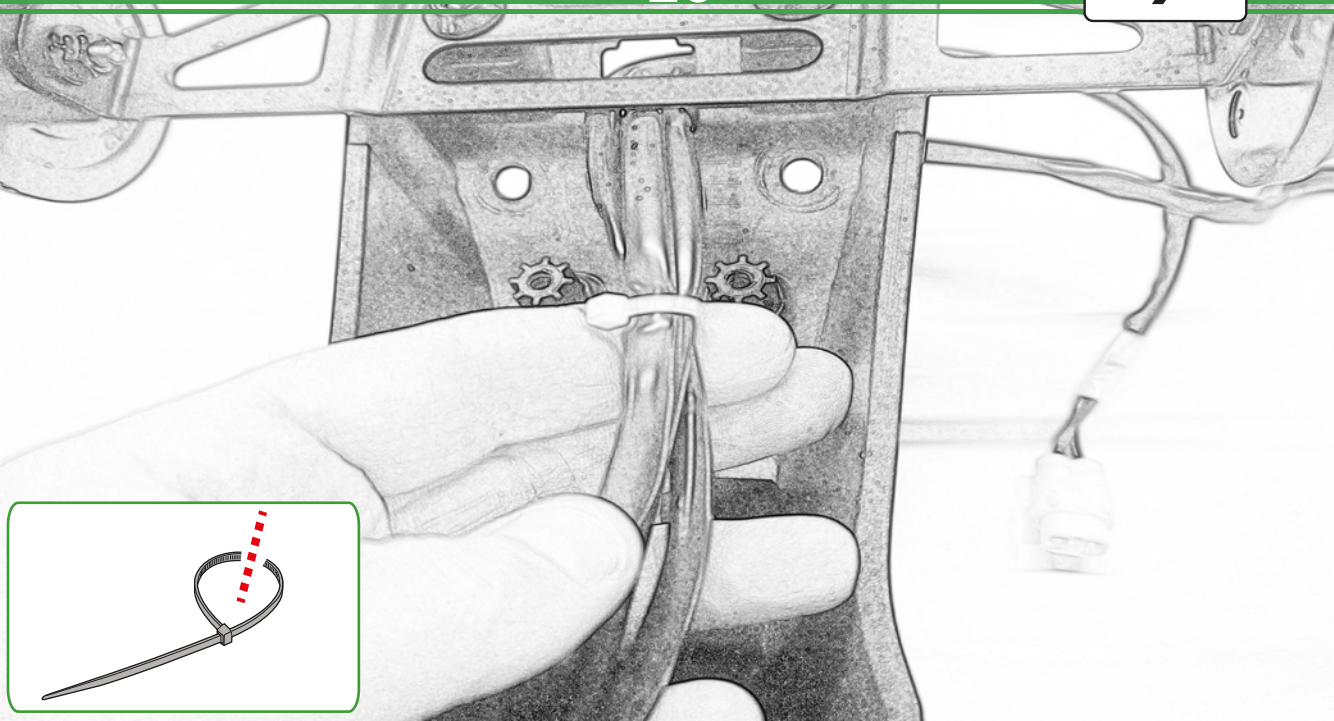

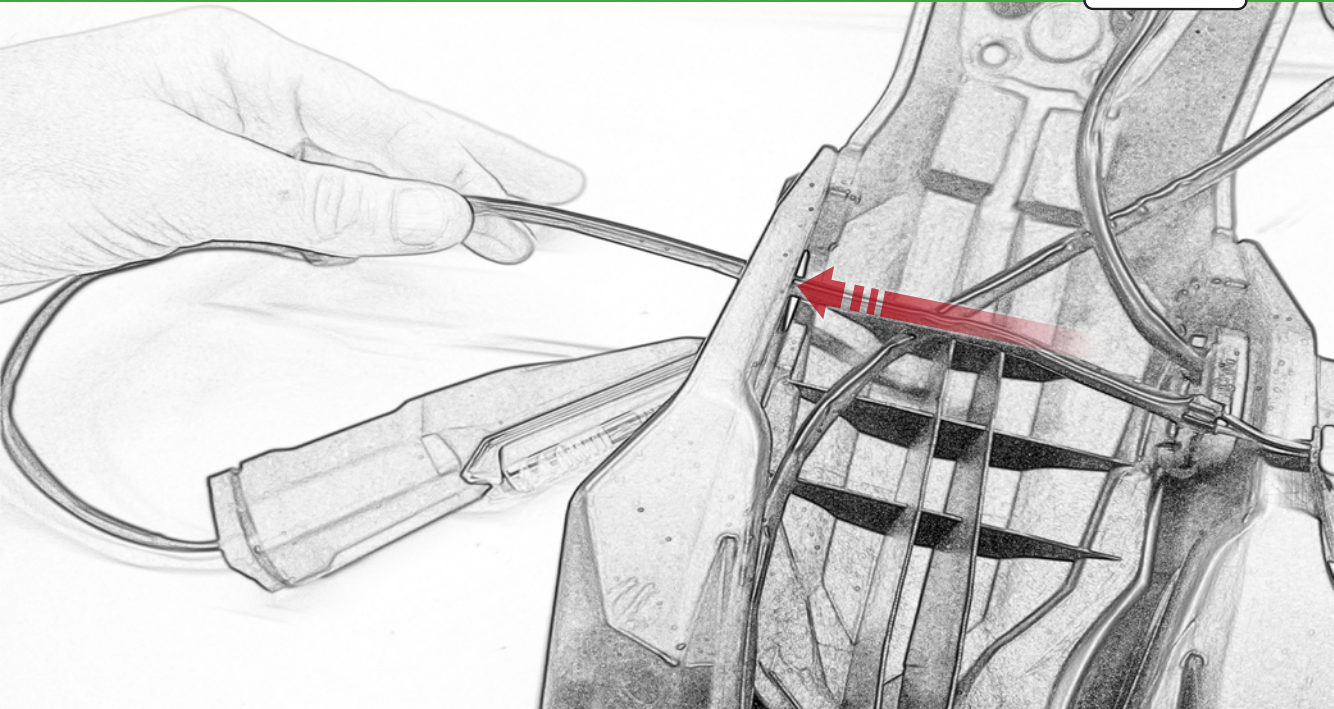

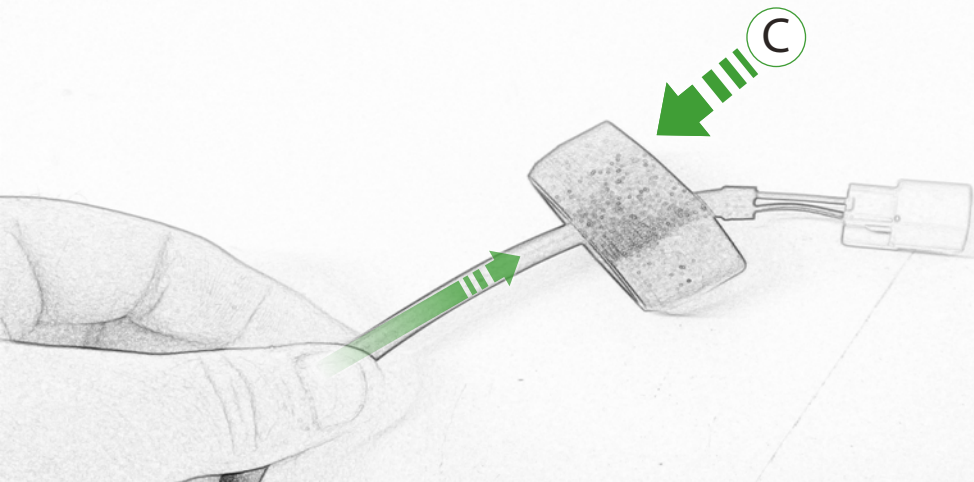

Repeat
Both Sides

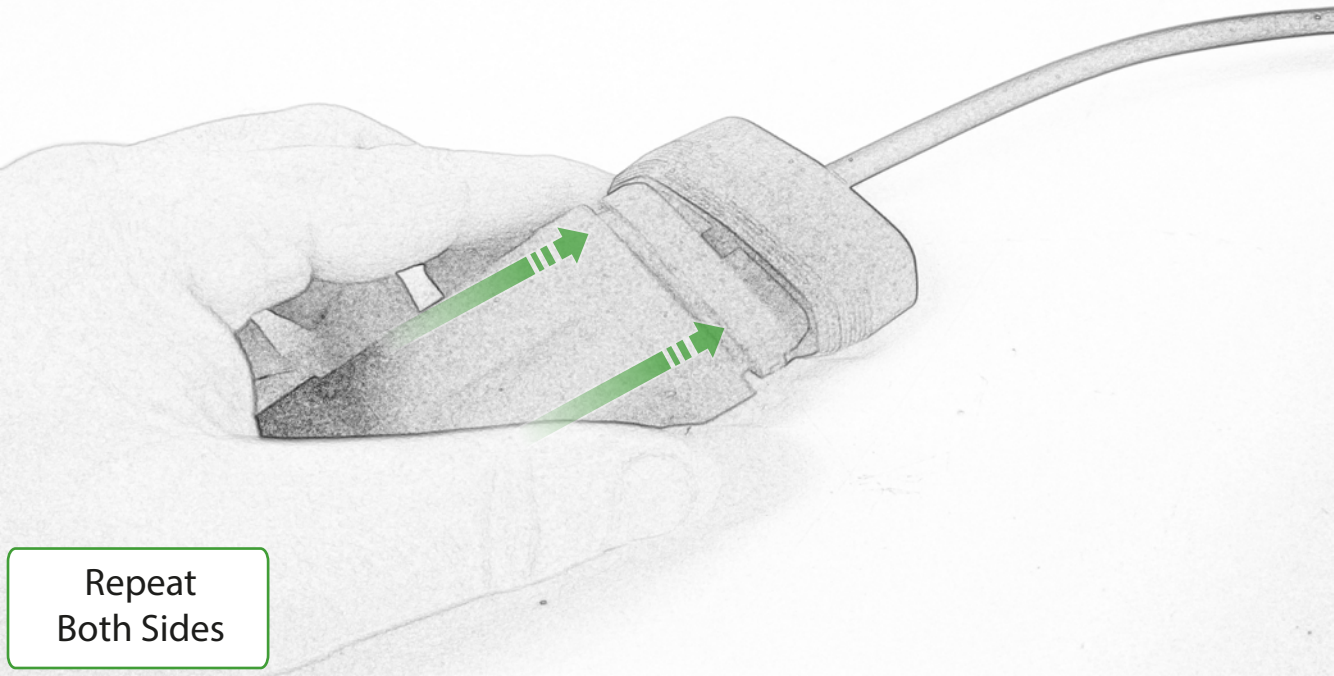

Repeat
Both Sides



OEM PART

Repeat
Both Sides



OEM PART 

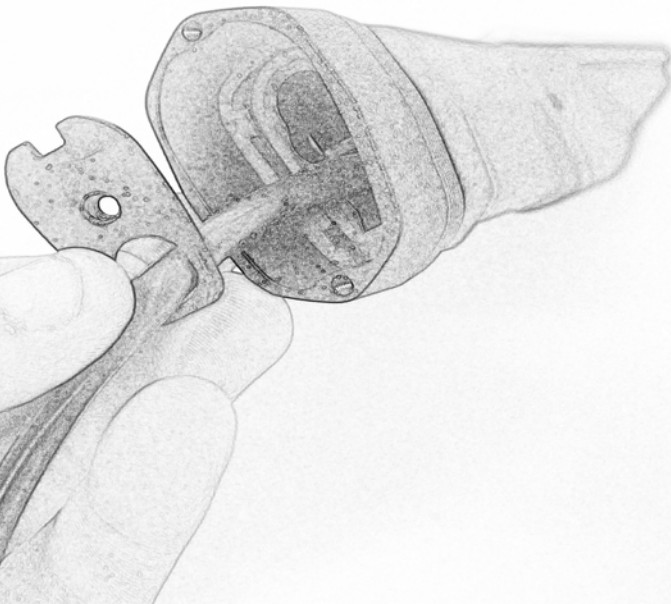

Repeat
Both Sides

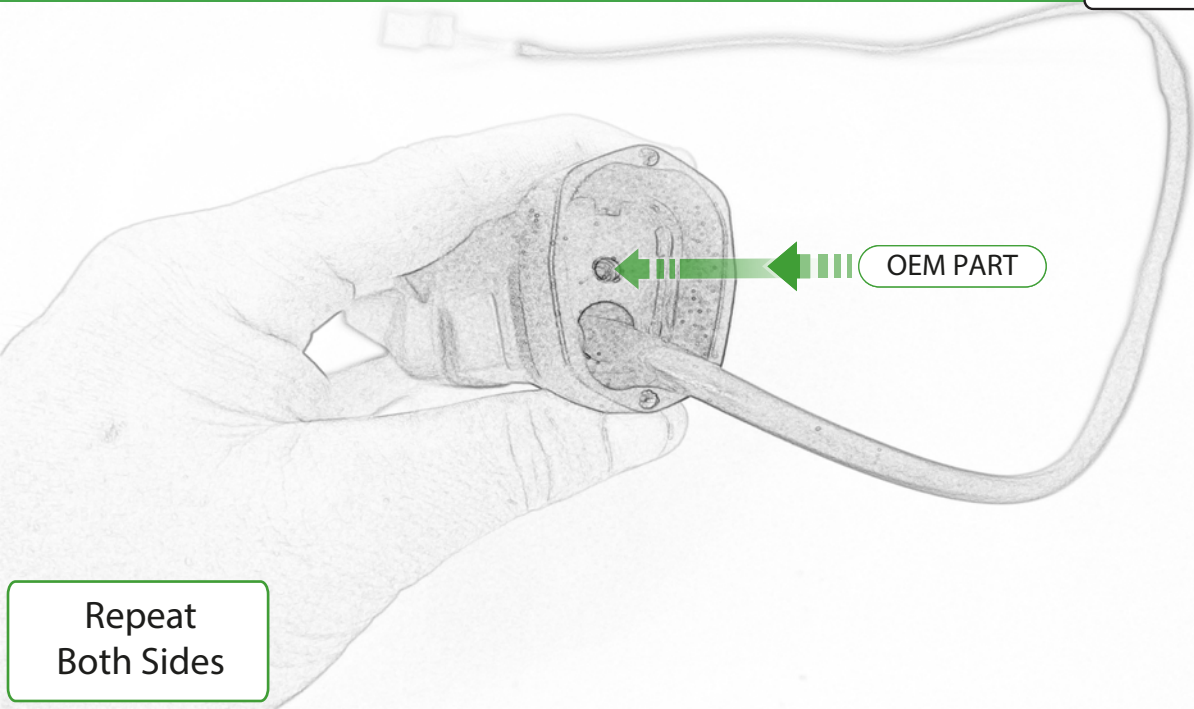

OEM PART

Repeat
Both Sides

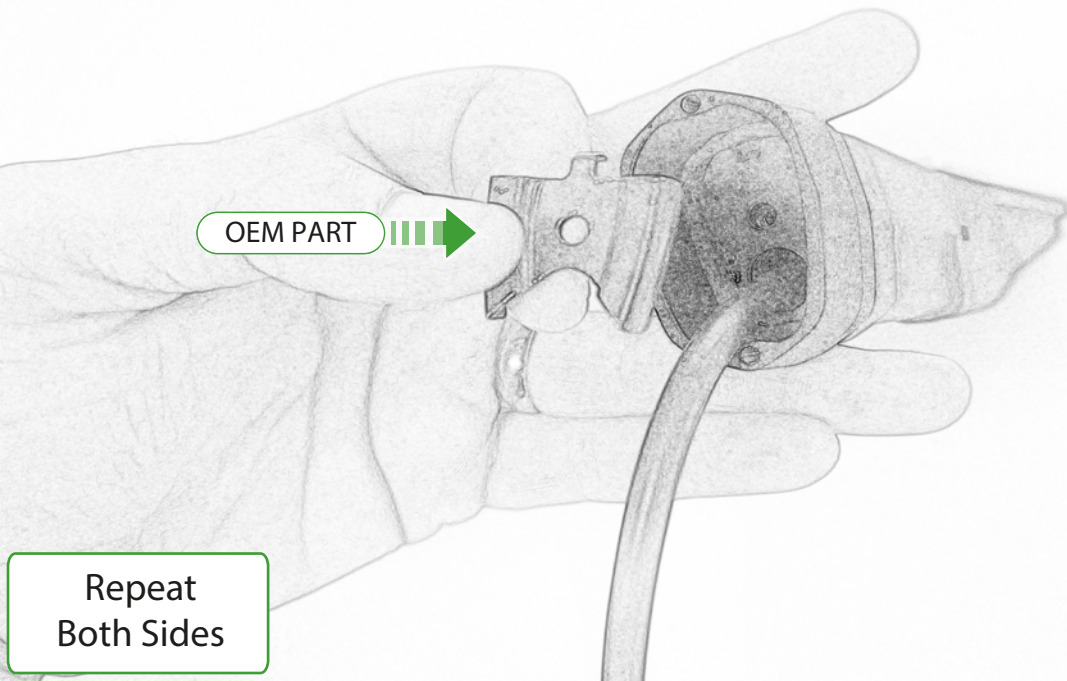

OEM PART 

Repeat
Both Sides

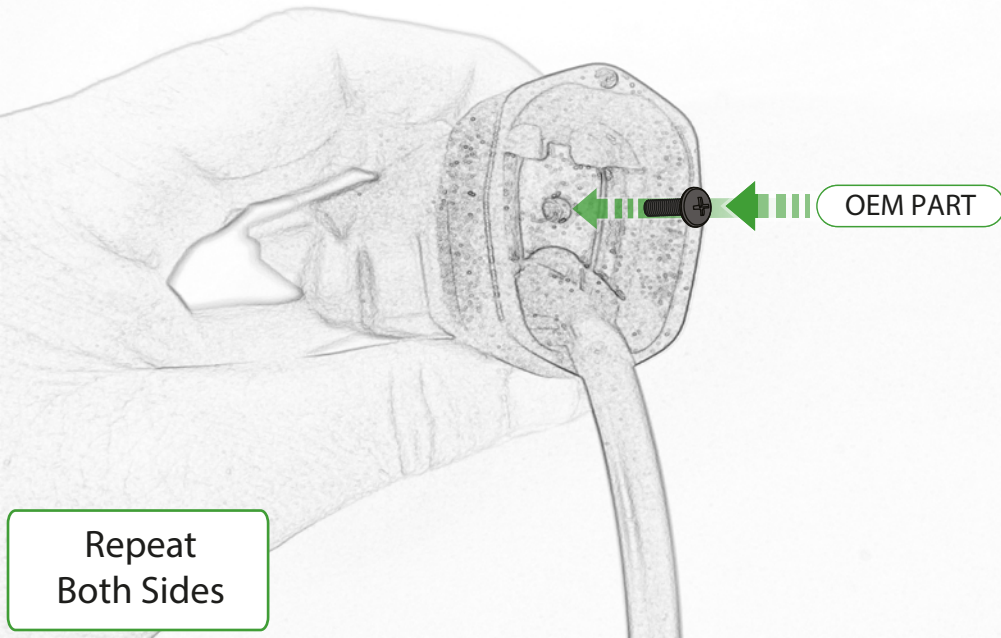

OEM PART

Repeat
Both Sides

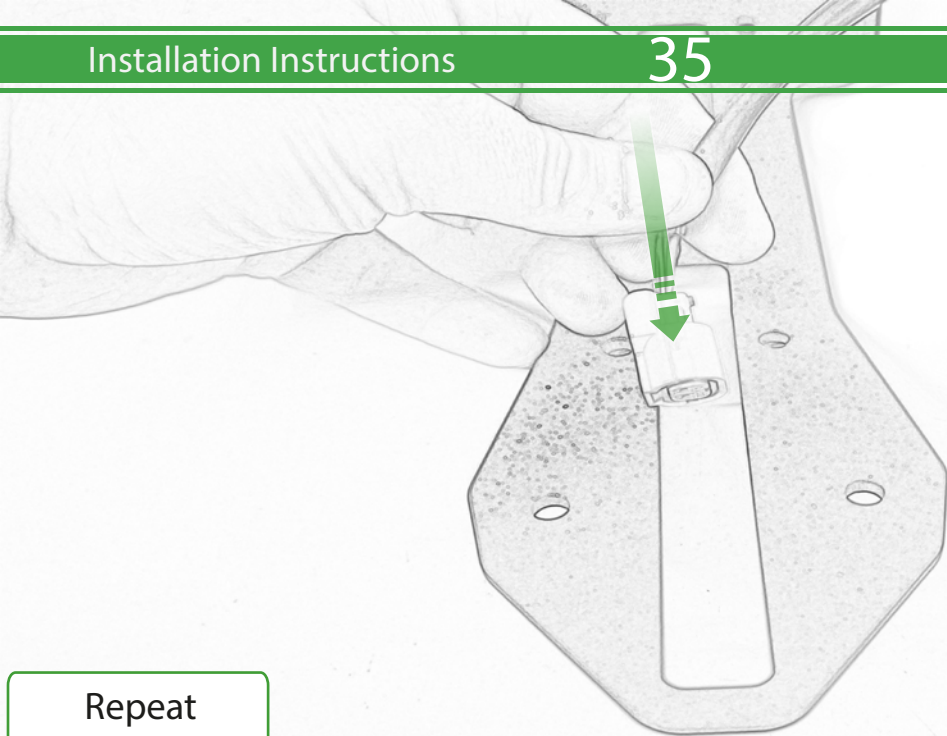

Repeat
Both Sides

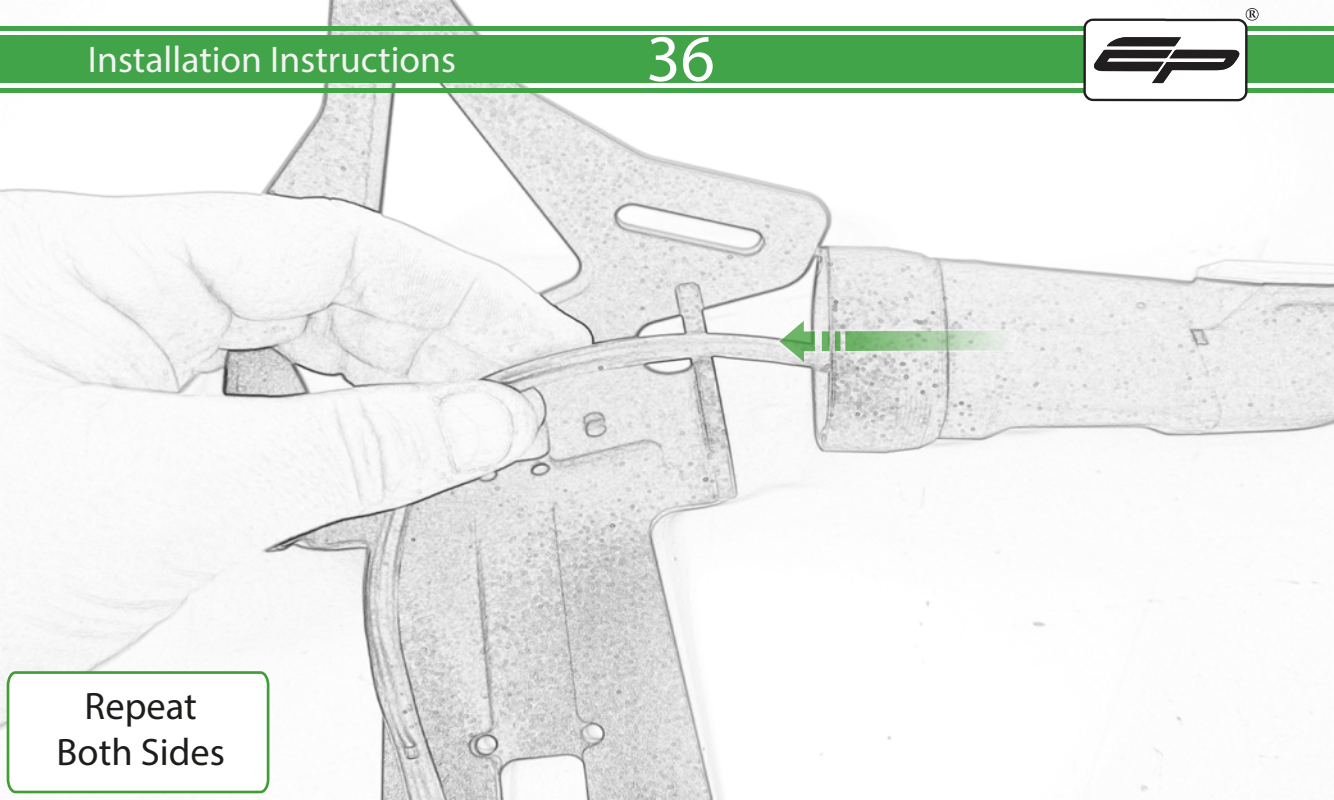

Repeat
Both Sides

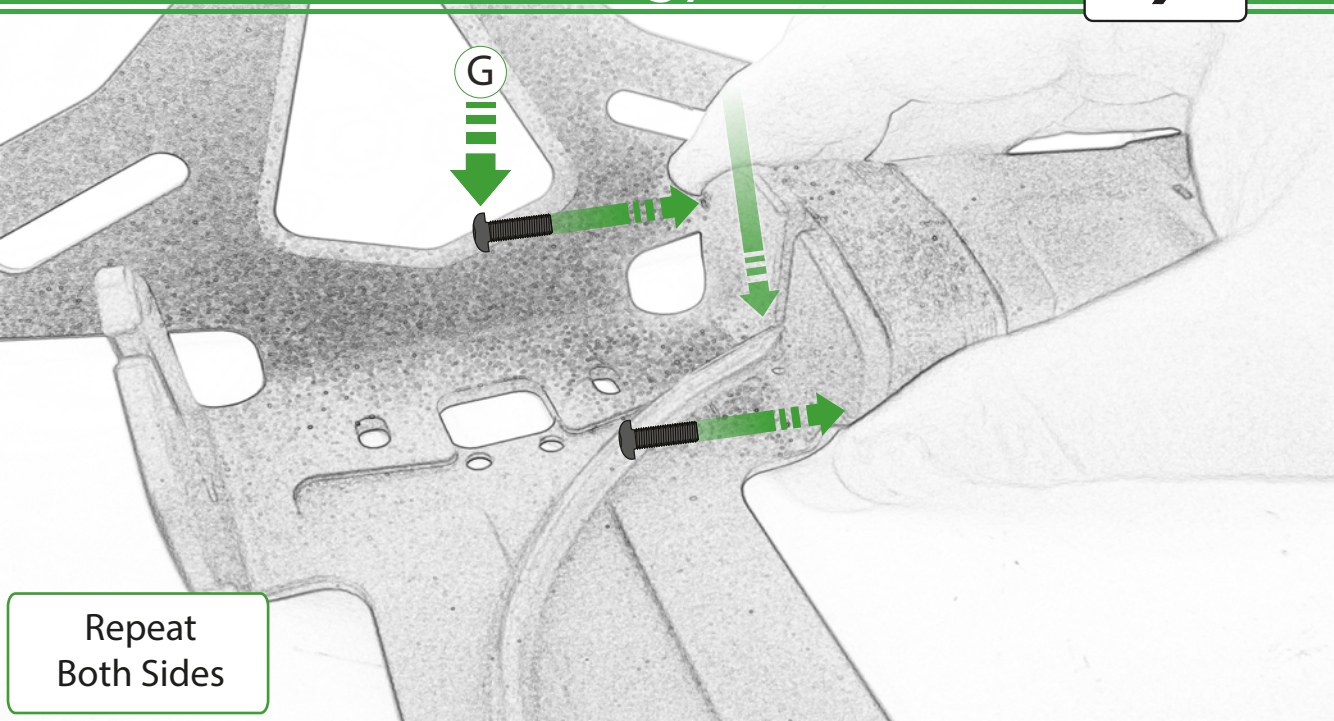

G



Repeat
Both Sides

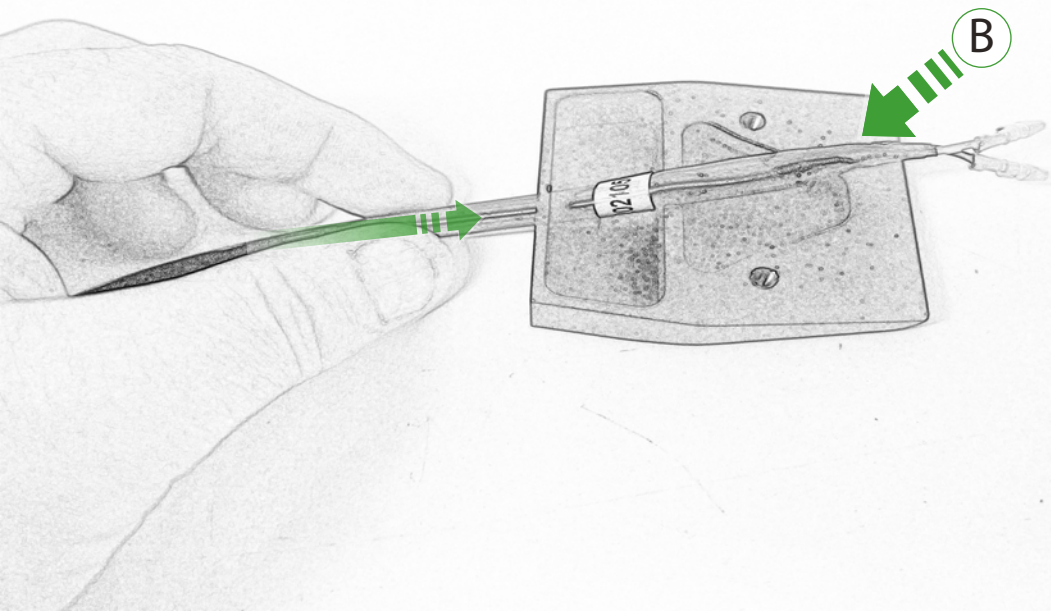

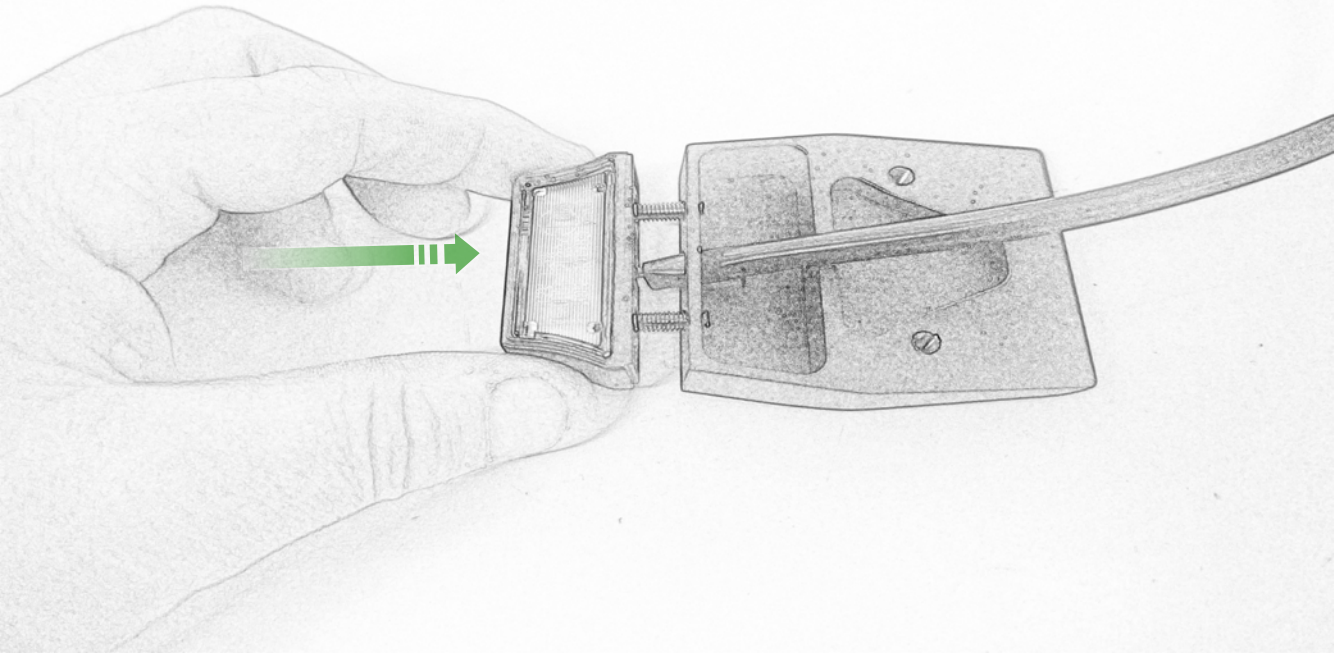

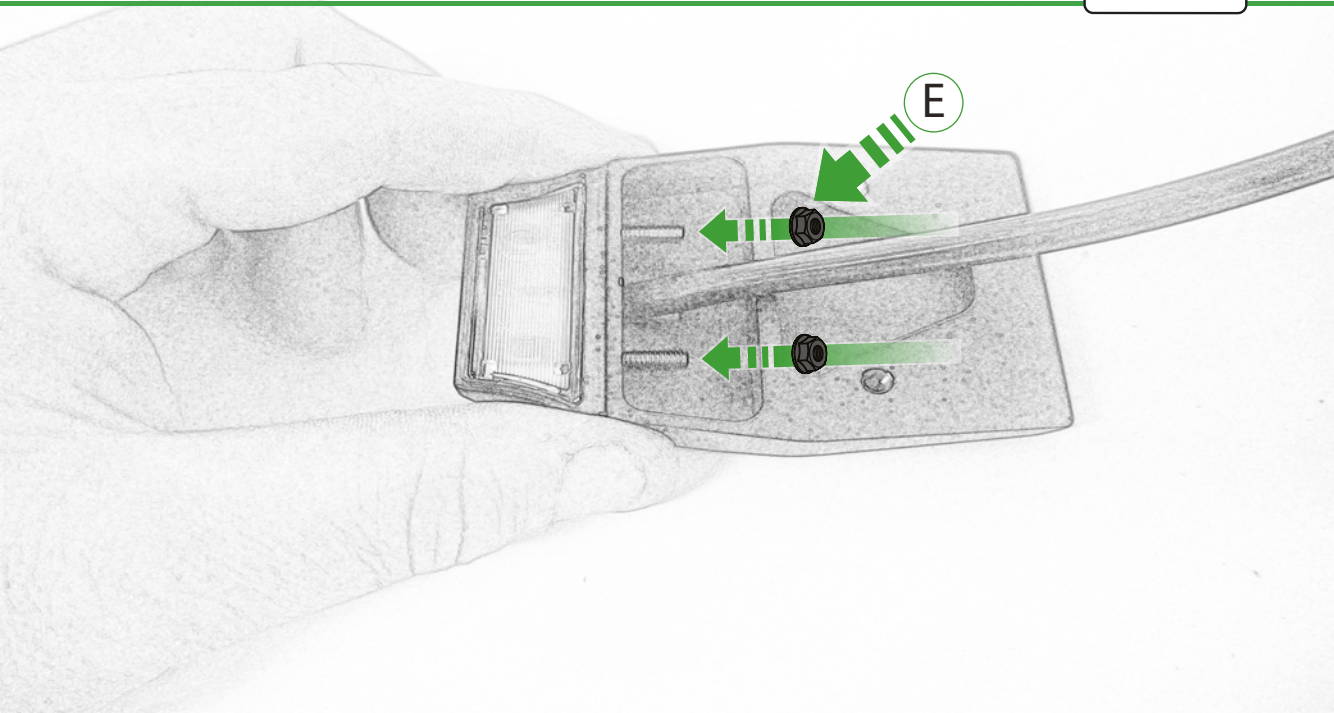

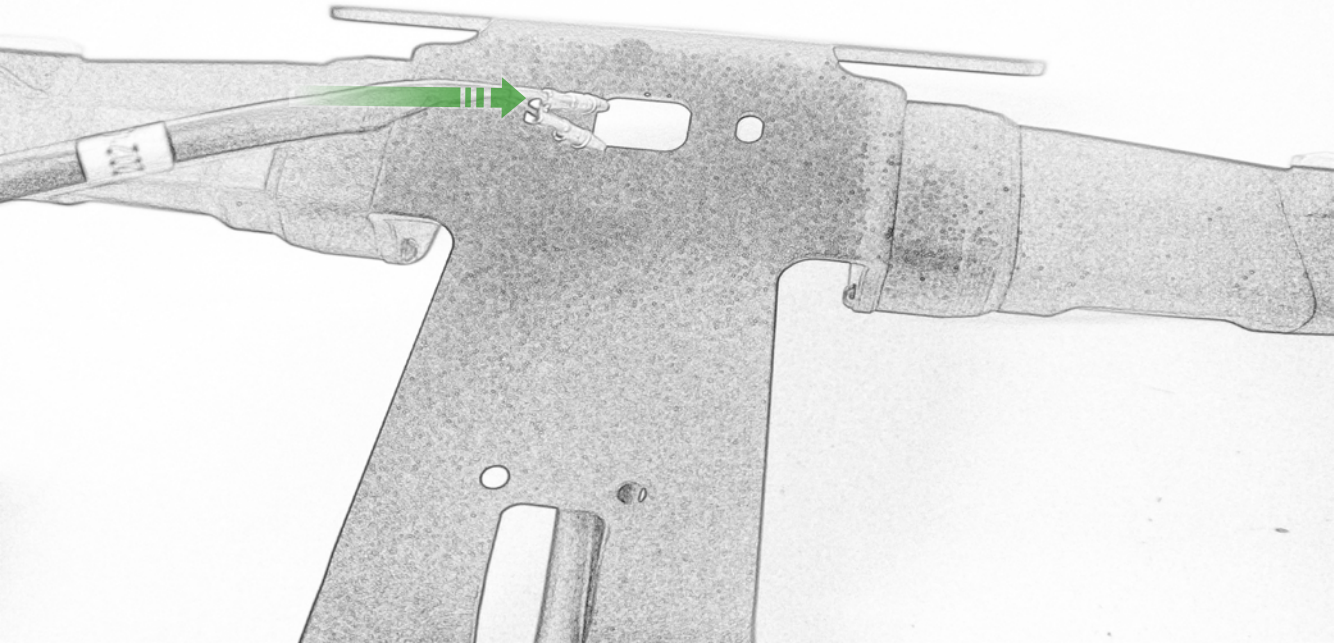

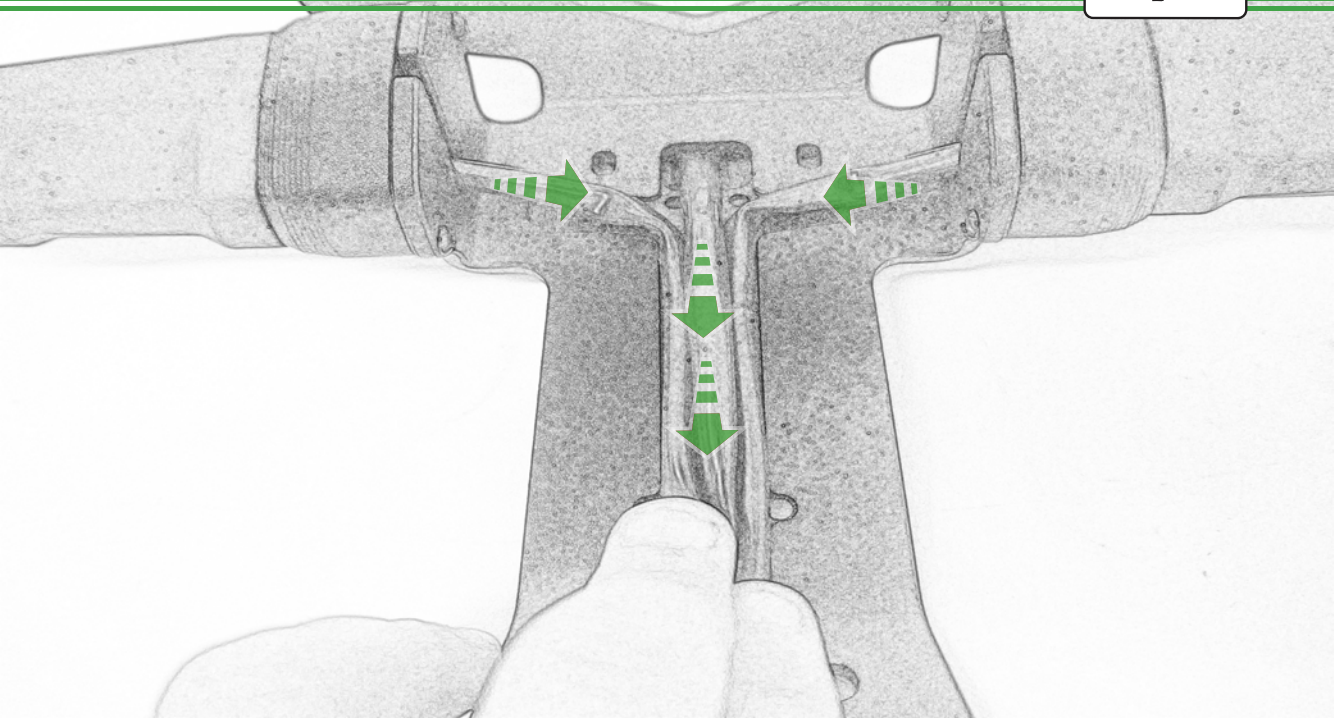

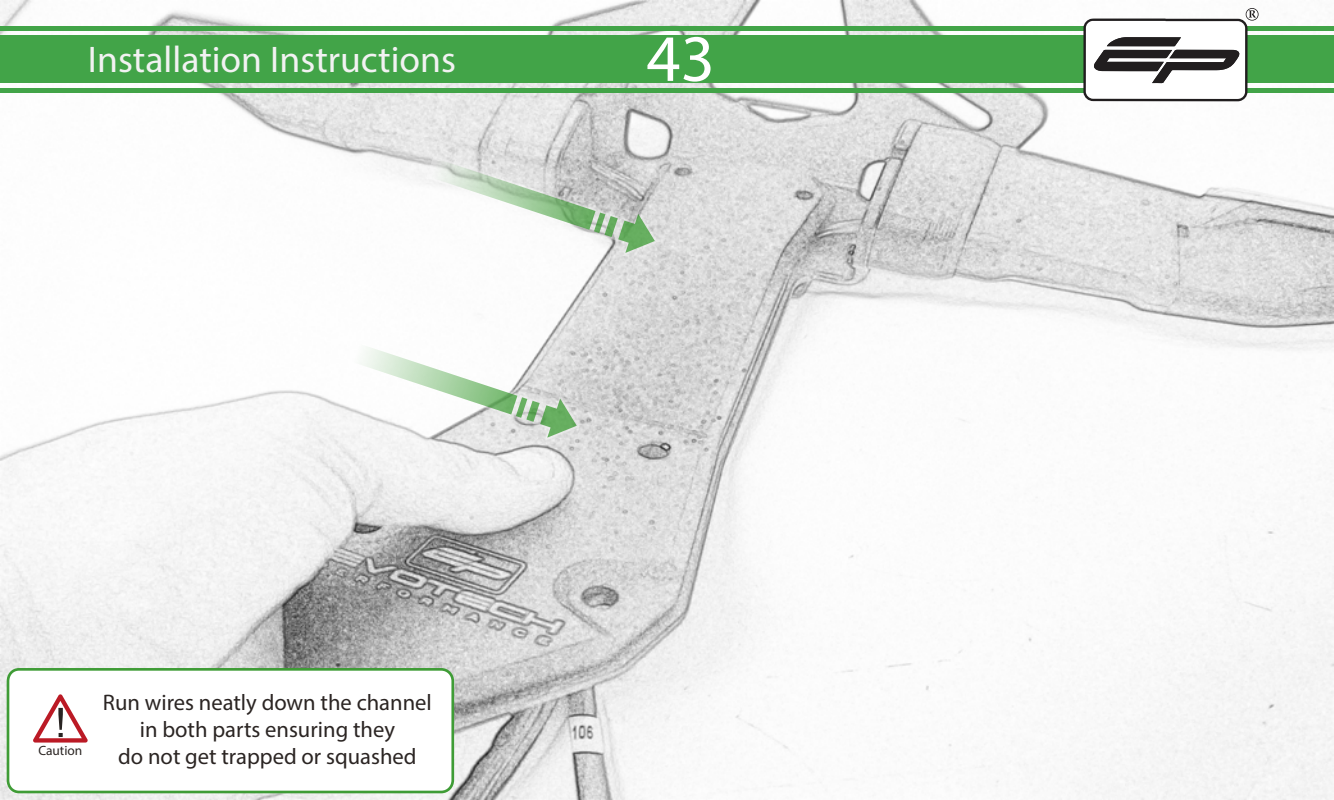

Caution

Run wires neatly down the channel in both parts ensuring they do not get trapped or squashed

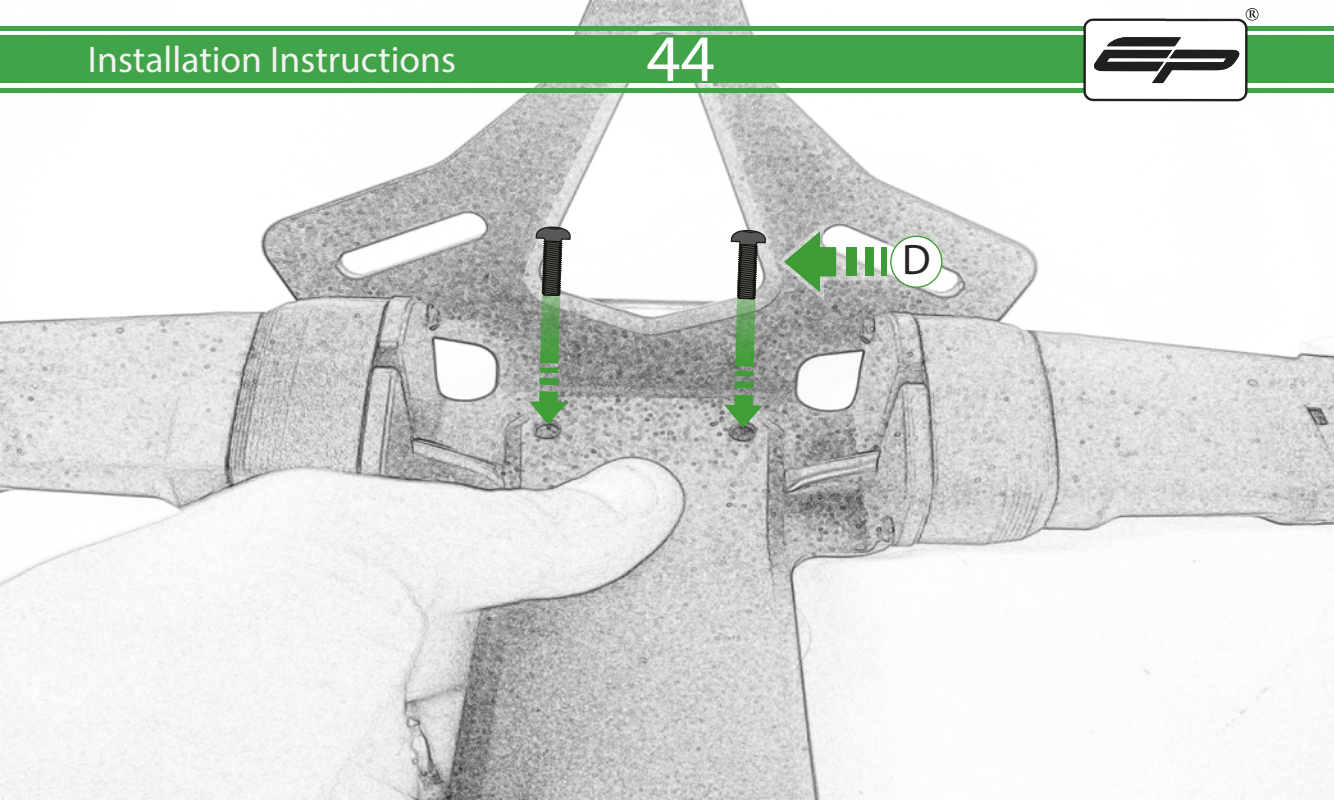

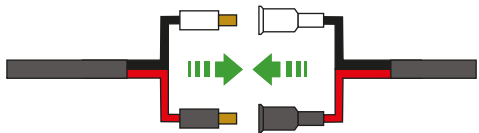
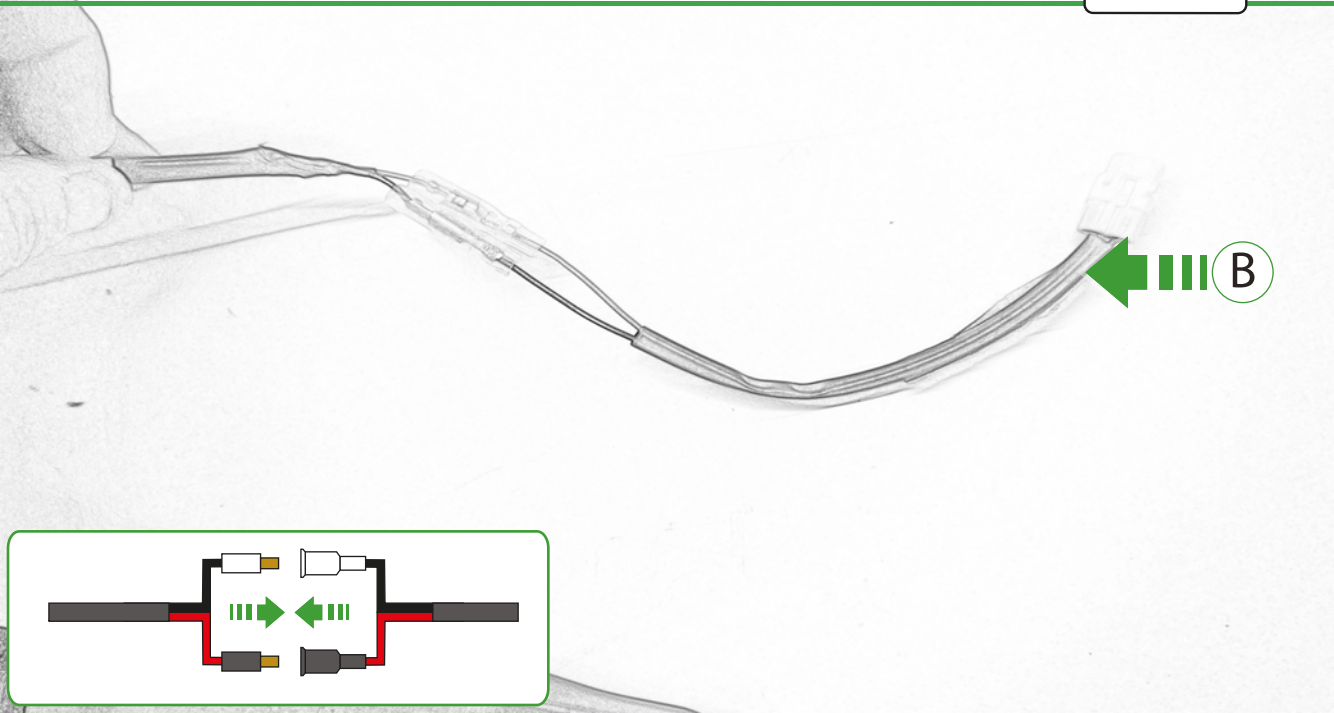

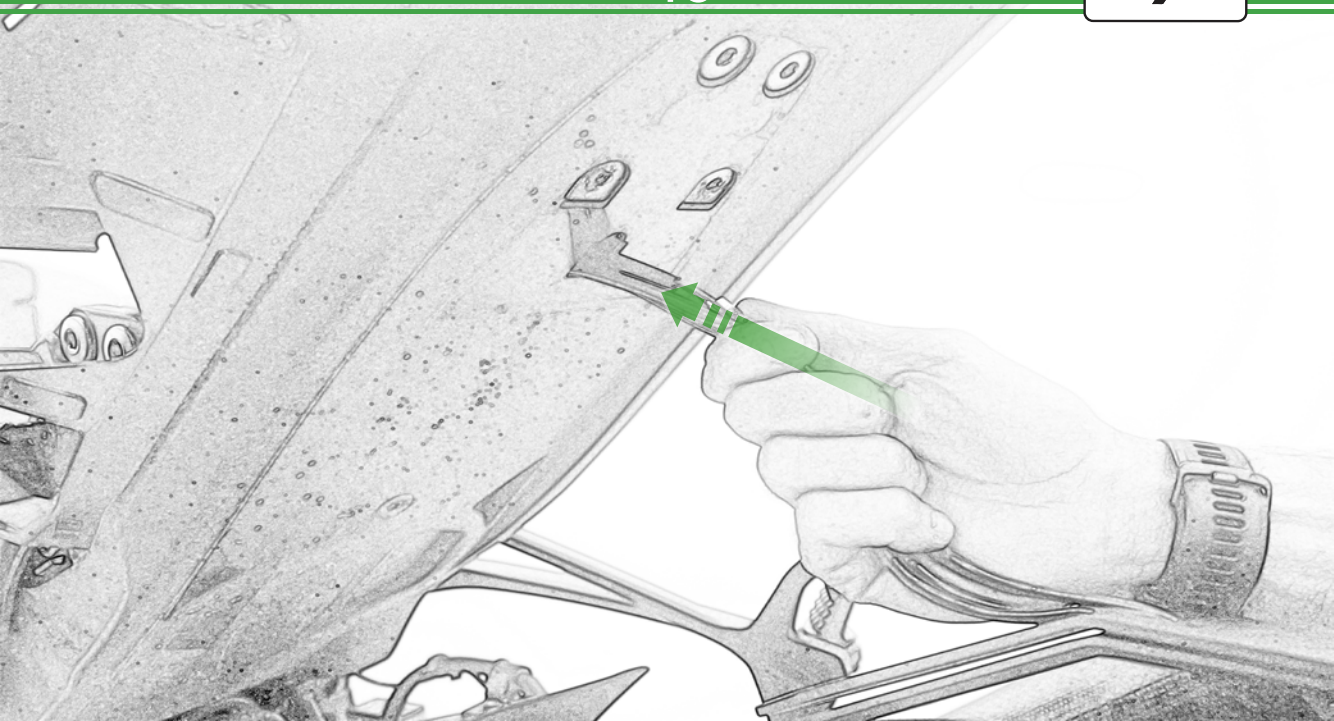

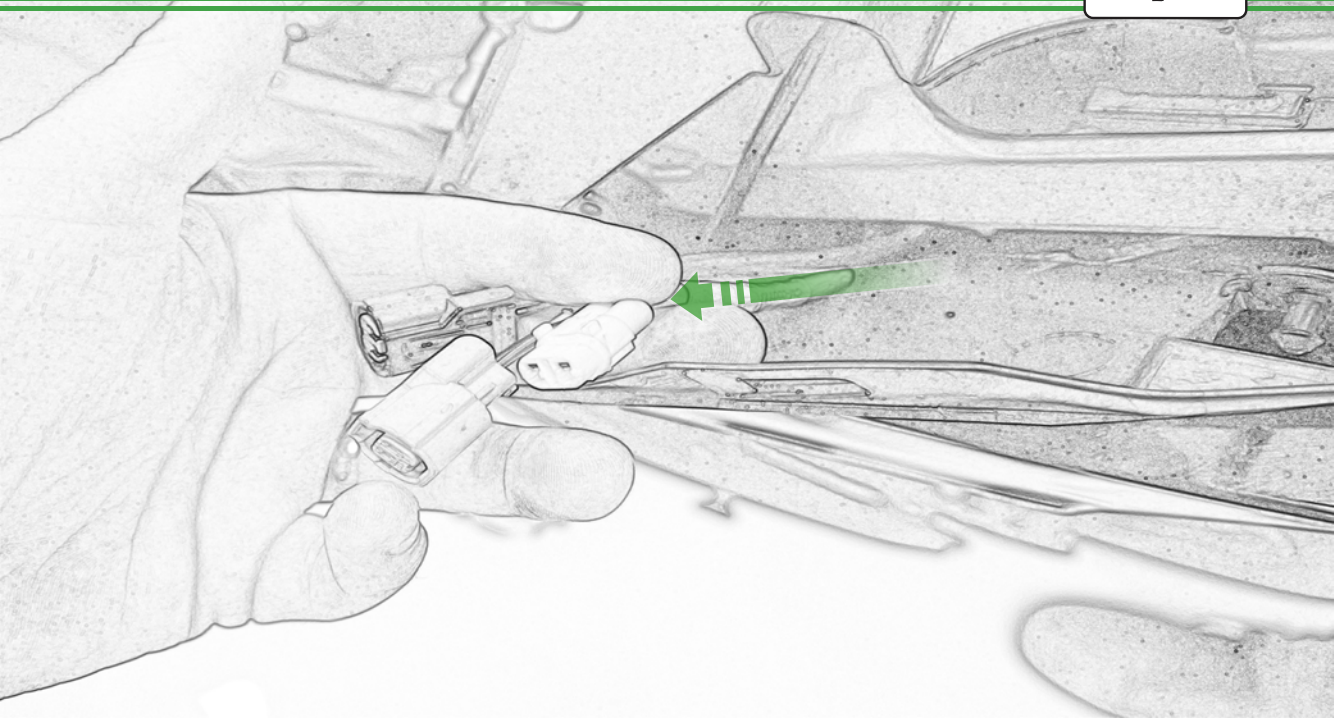



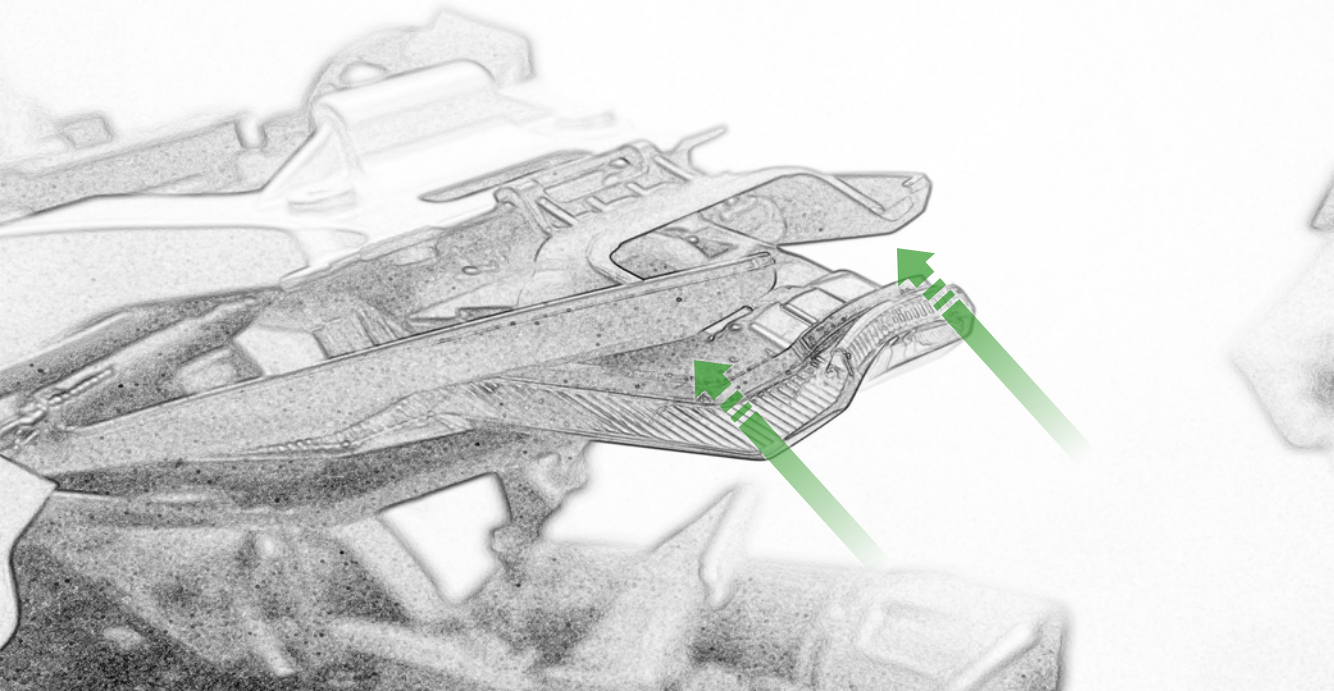

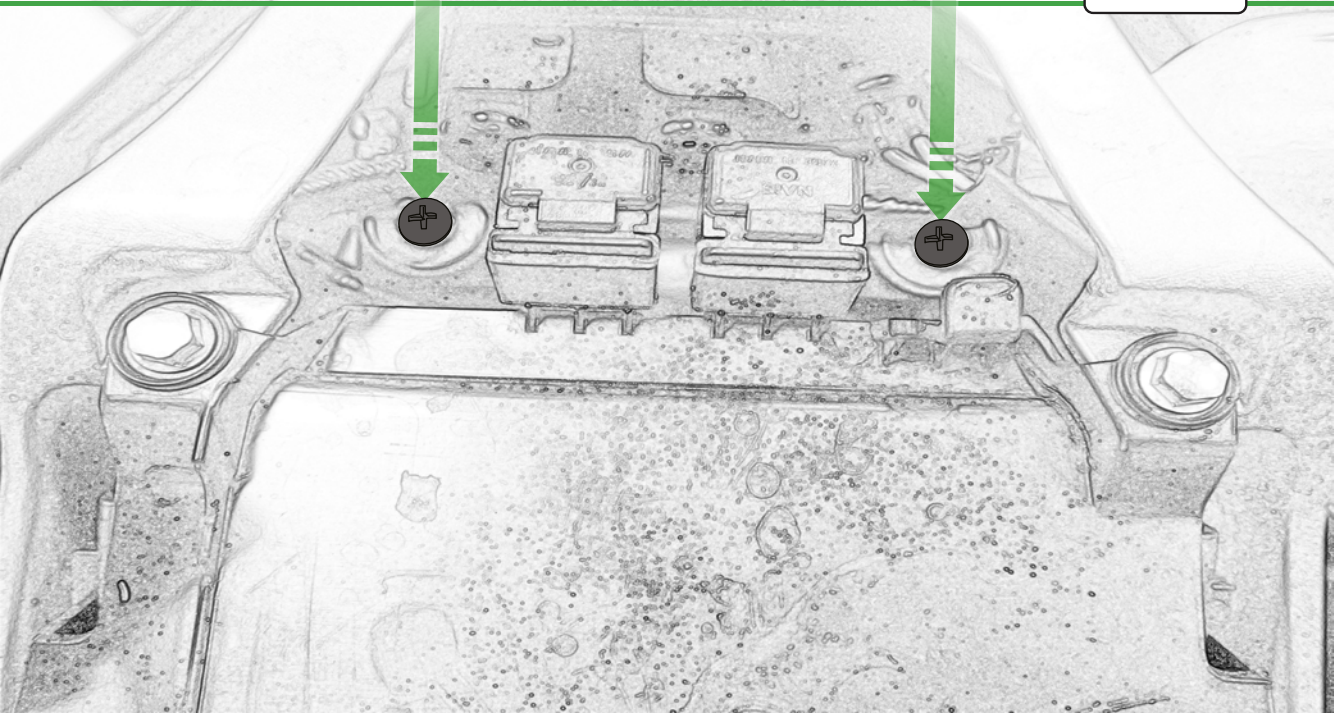

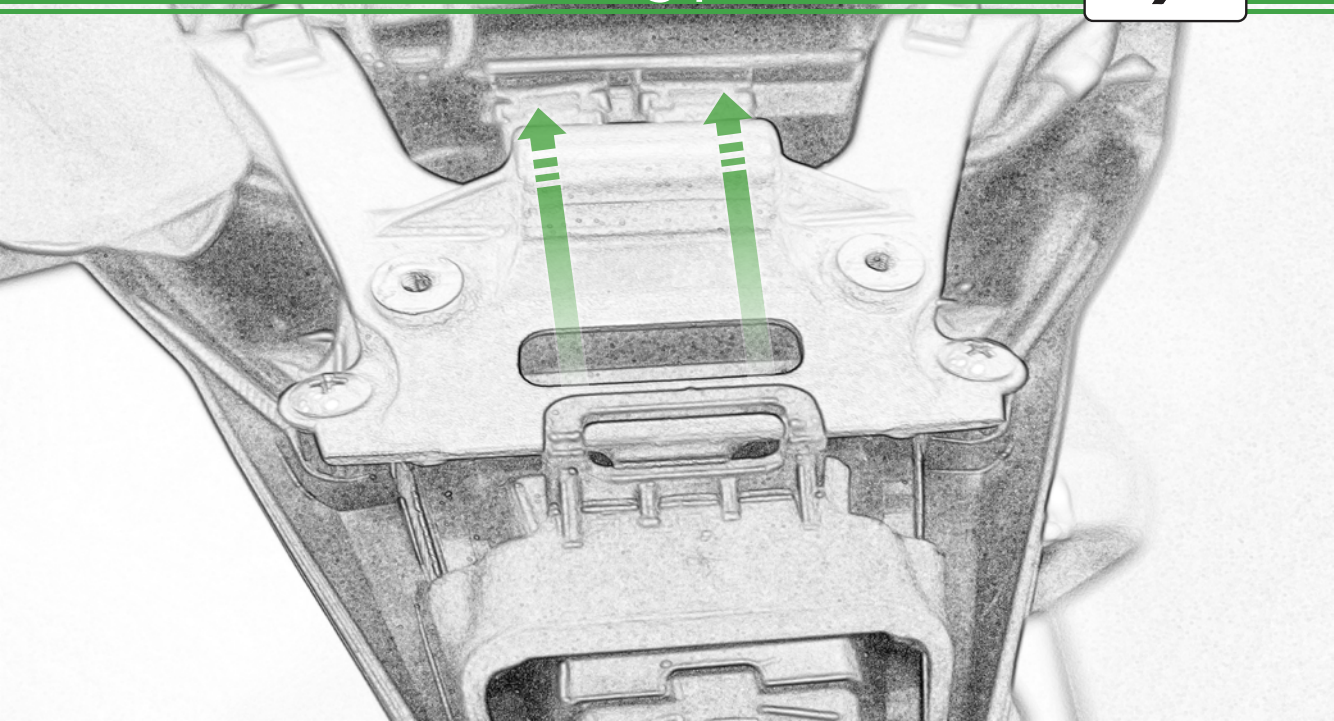

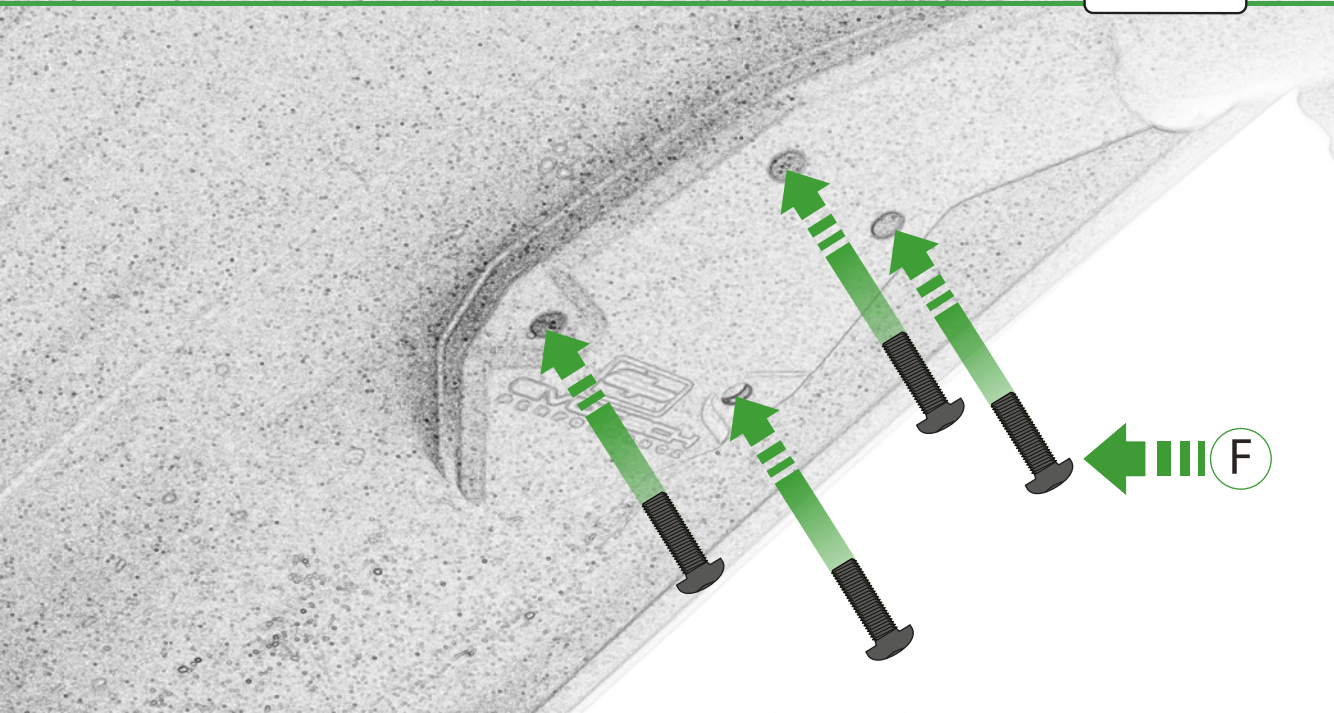

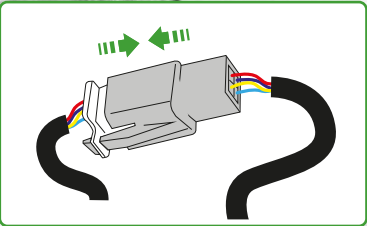
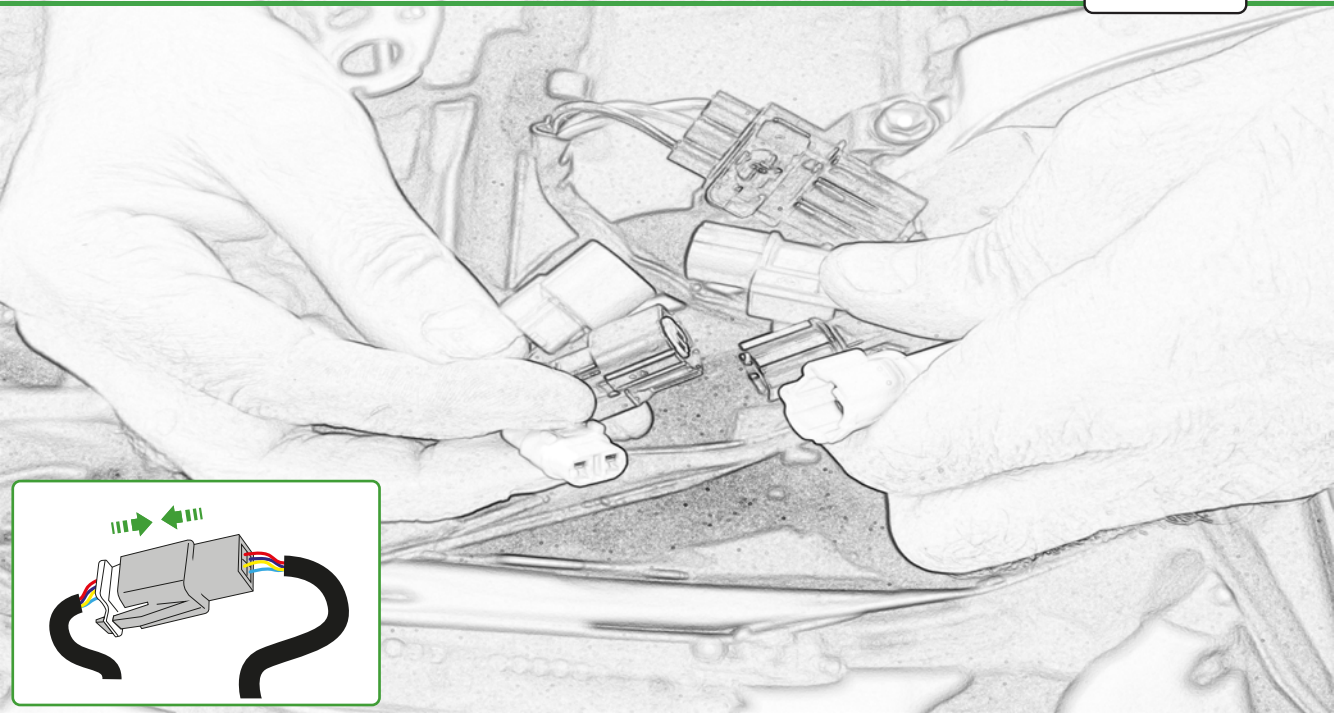

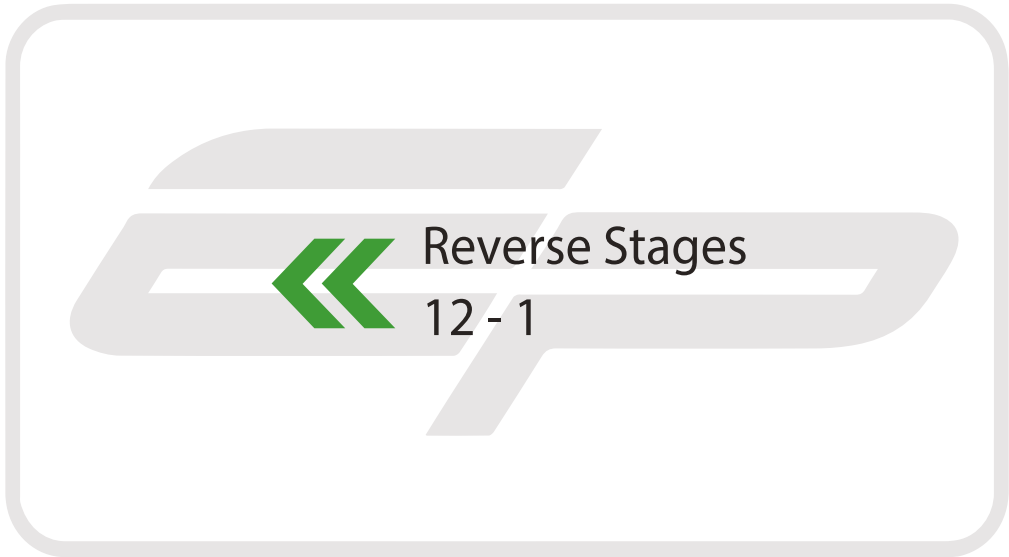

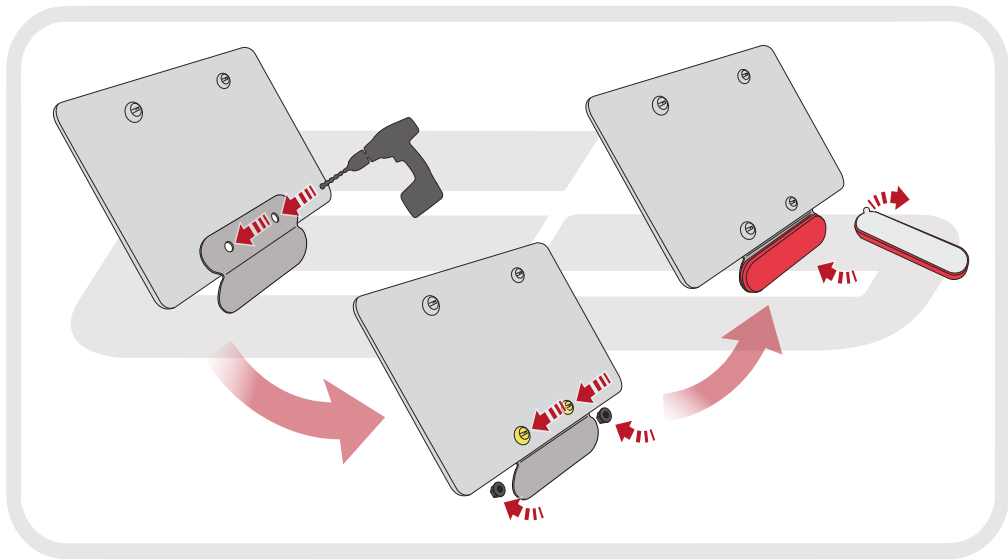

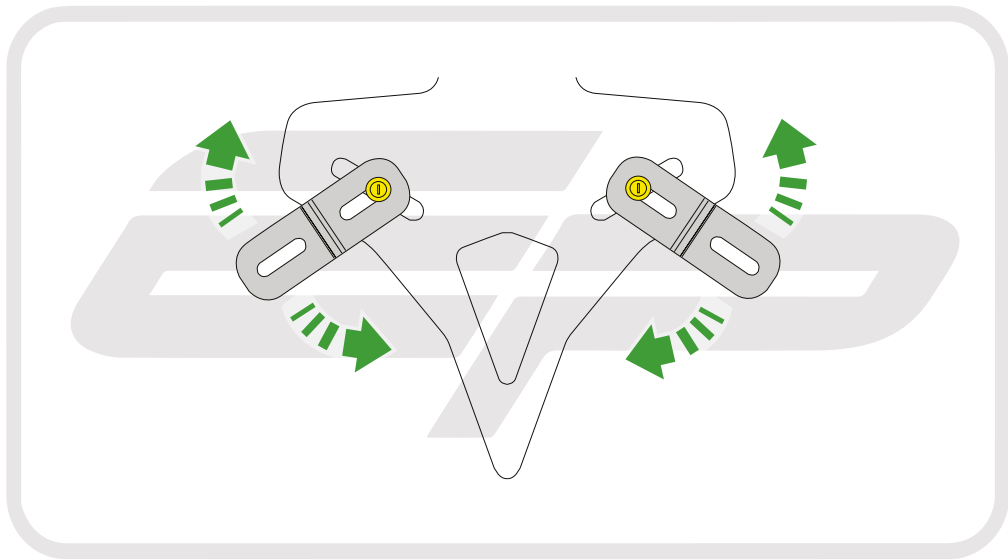



EVOTECH®
P E R F O R M A N C E

www.evotech-performance.com