

EVOTECH®
P E R F O R M A N C E

www.evotech-performance.com

Africa Twin Tail Tidy

Installation Instructions



Kit Contents PRN014796

- (A) 1 x Undertray
- (B) 1 x Loom Connector
- (C) 1 x Number Plate Bracket
- (D) 1 x Mounting Plate
- (E) 1 x Light Bracket
- (F) 1 x Number Plate Light
- (G) 1 x Main Body Right
- (H) 1 x Main Body Left
- (I) 1 x Reflector Kit
- (J) 2 x Special Washer
- (K) 2 x M4 x 8mm Button Head Bolt
- (L) 2 x M5 x 12mm Button Head Bolt
- (M) 2 x M6 x 10mm Button Head Bolt
- (N) 2 x M6 x 20mm Button Head Bolt
- (O) 2 x M6 x 25mm Button Head Bolt
- (P) 2 x M4 Nylock Nuts
- (Q) 2 x Indicator Stems
- (R) 4 x M4 x 12mm Button Head Bolts
- (S) 4 x M6 x 12mm Button Head Bolts

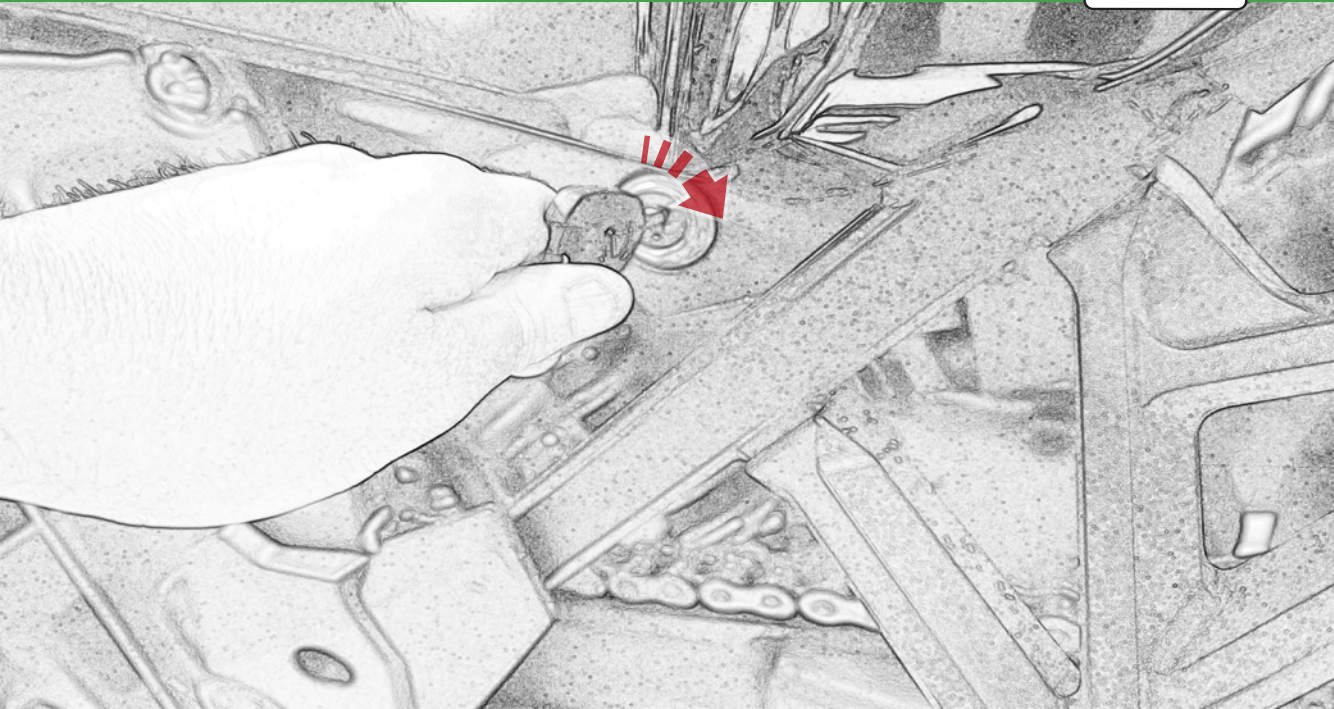

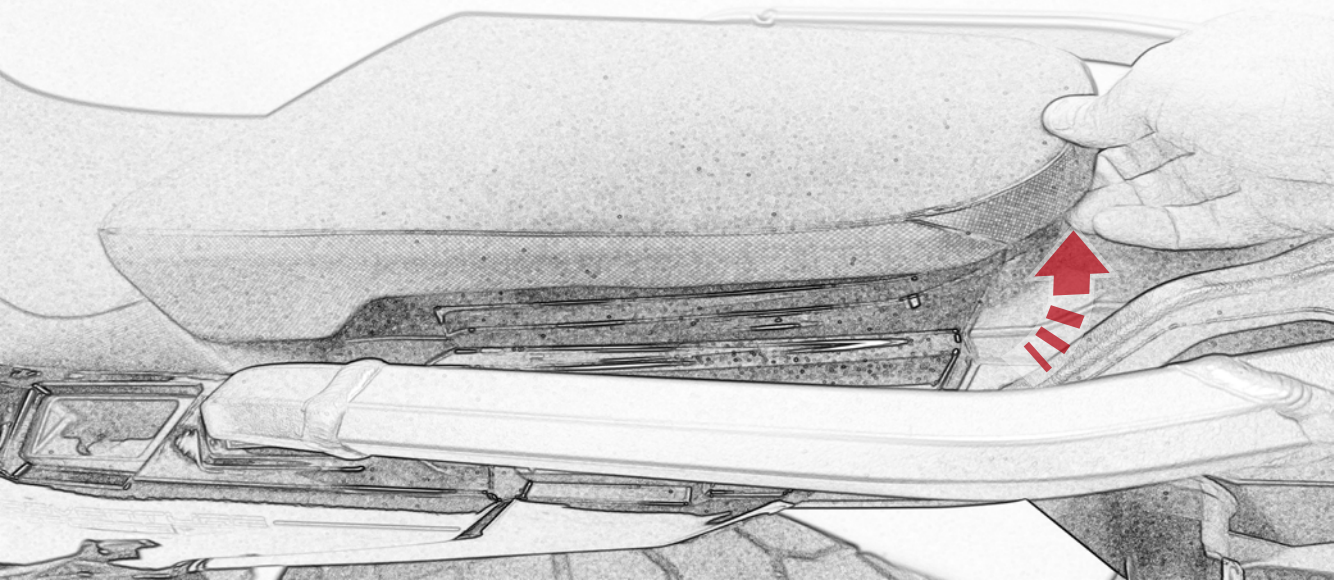

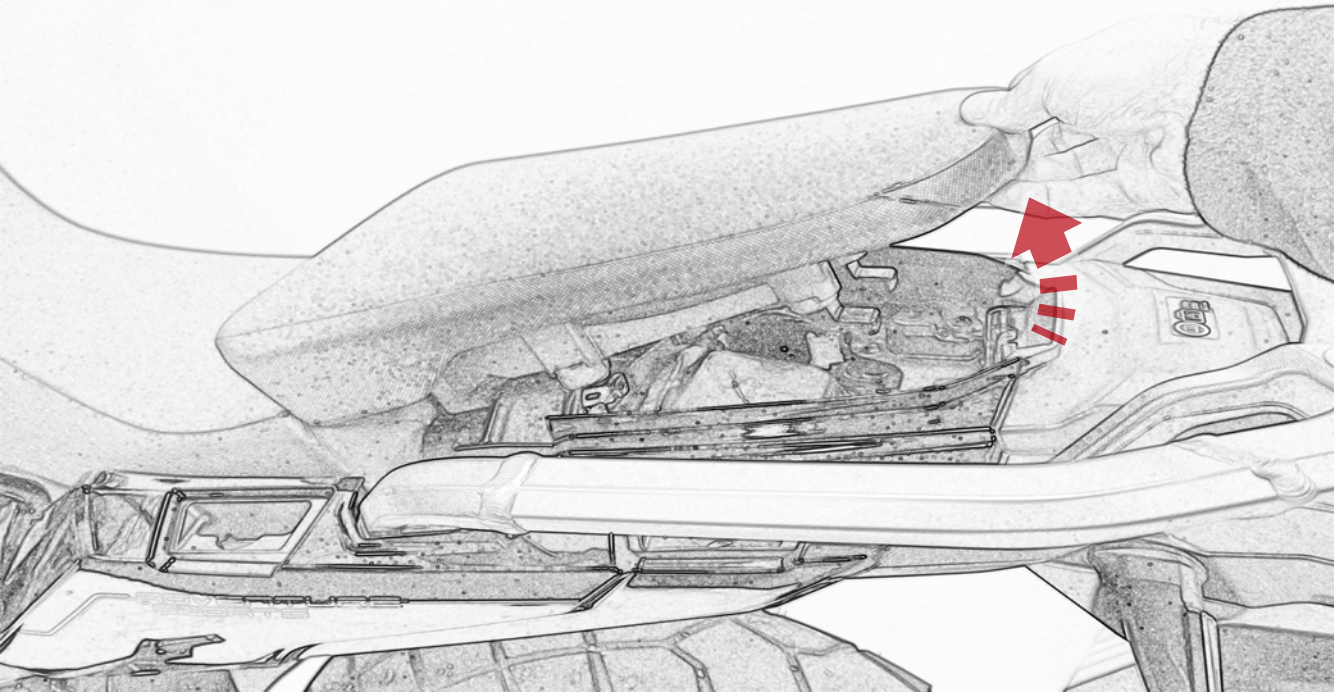

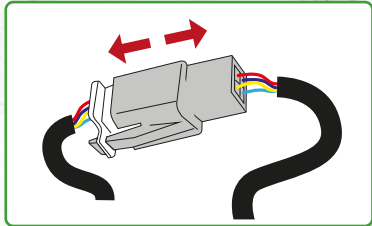

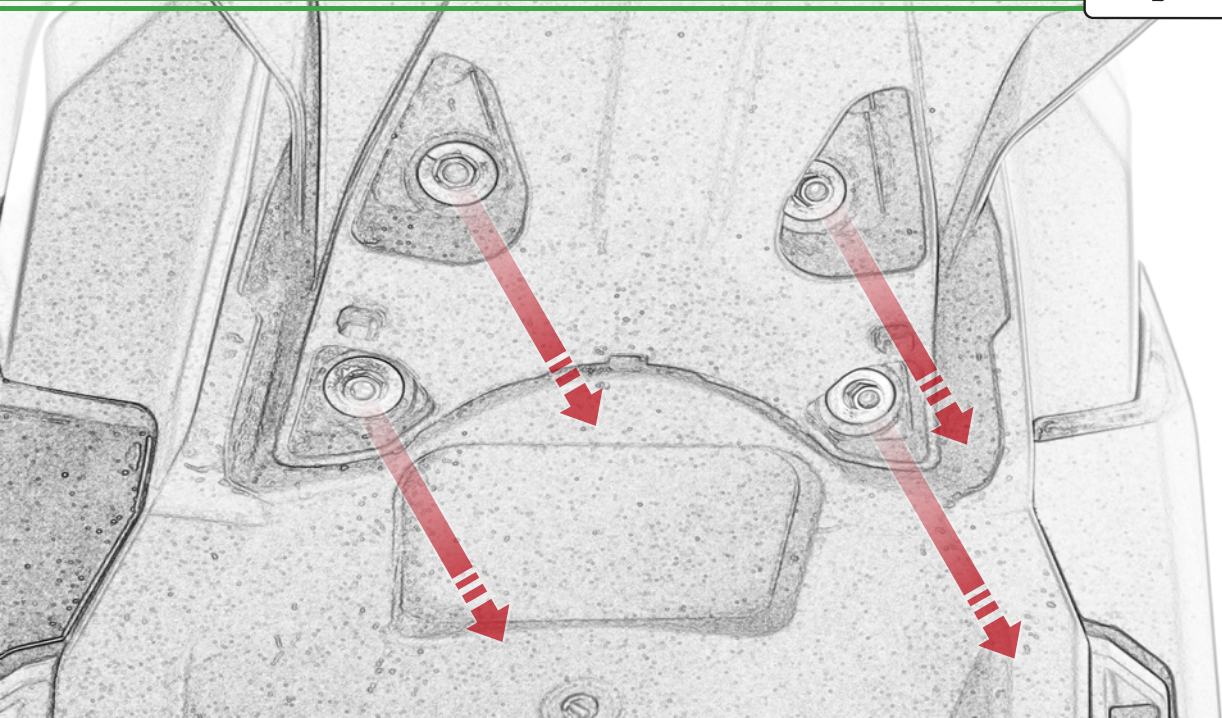

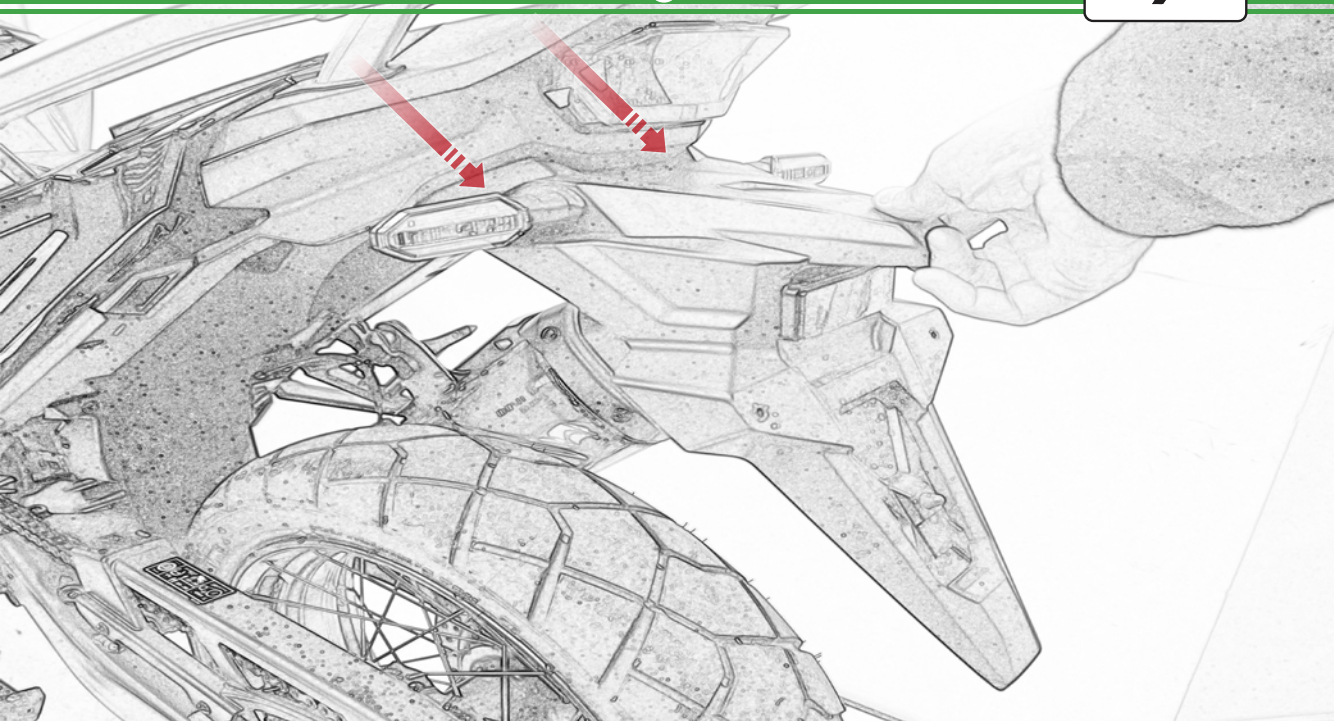

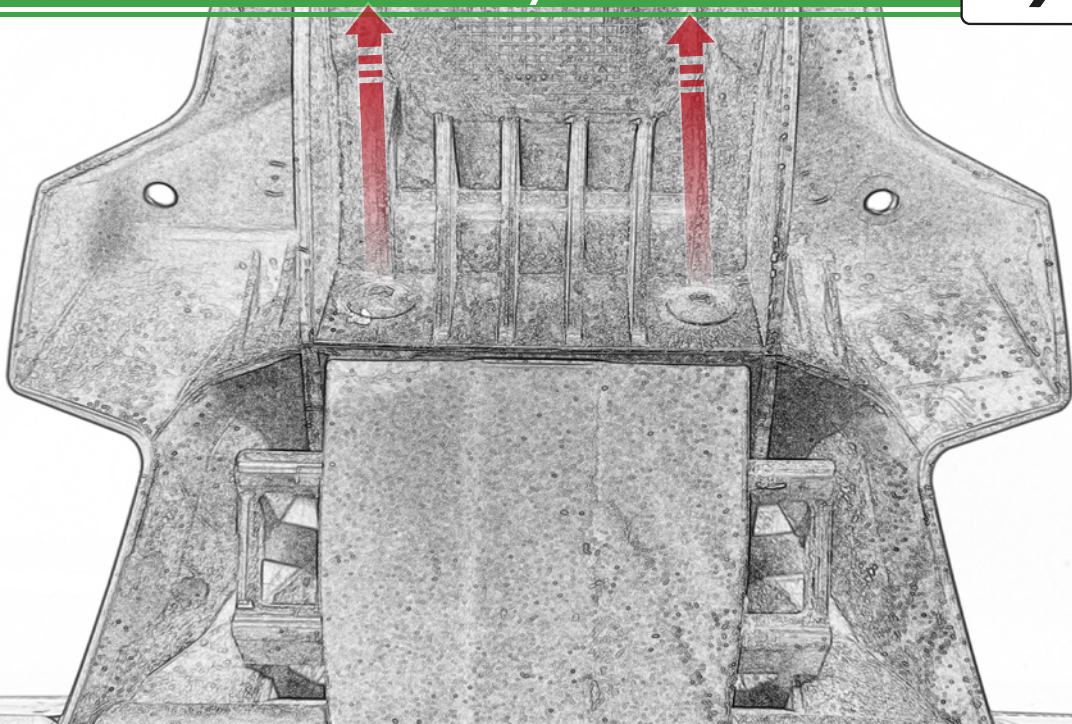

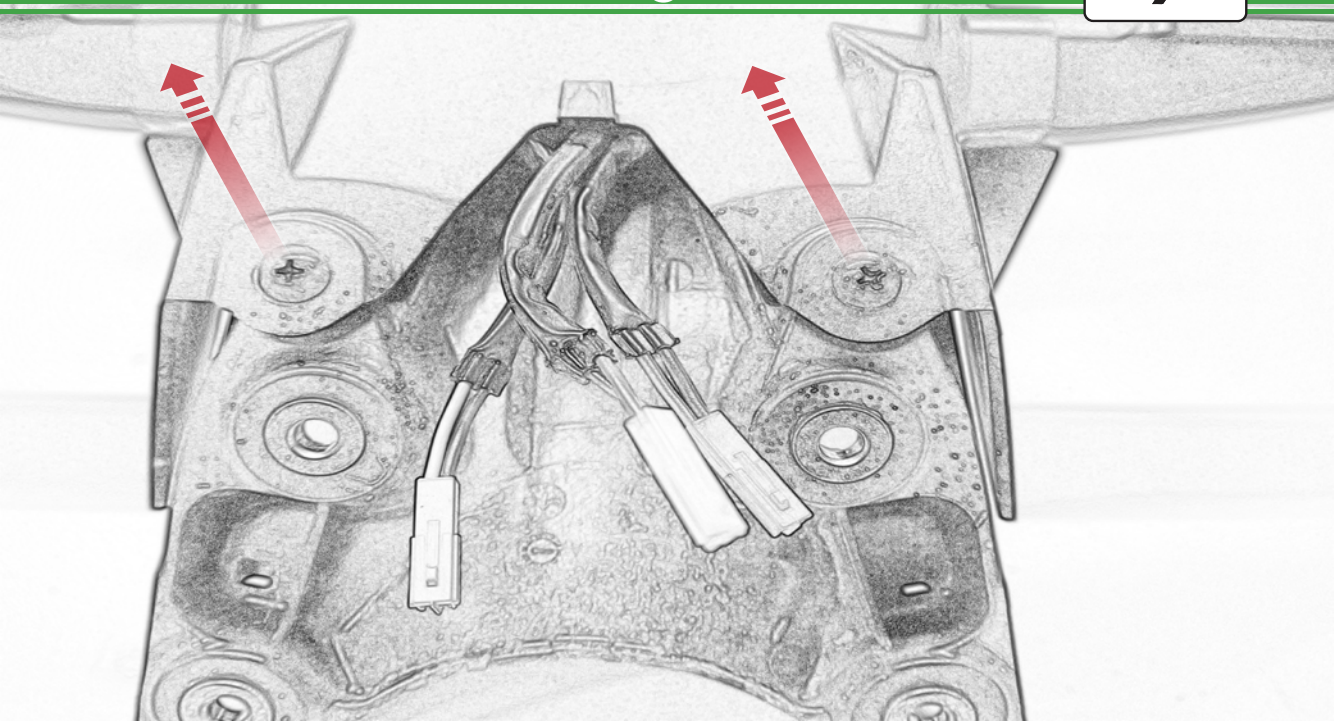

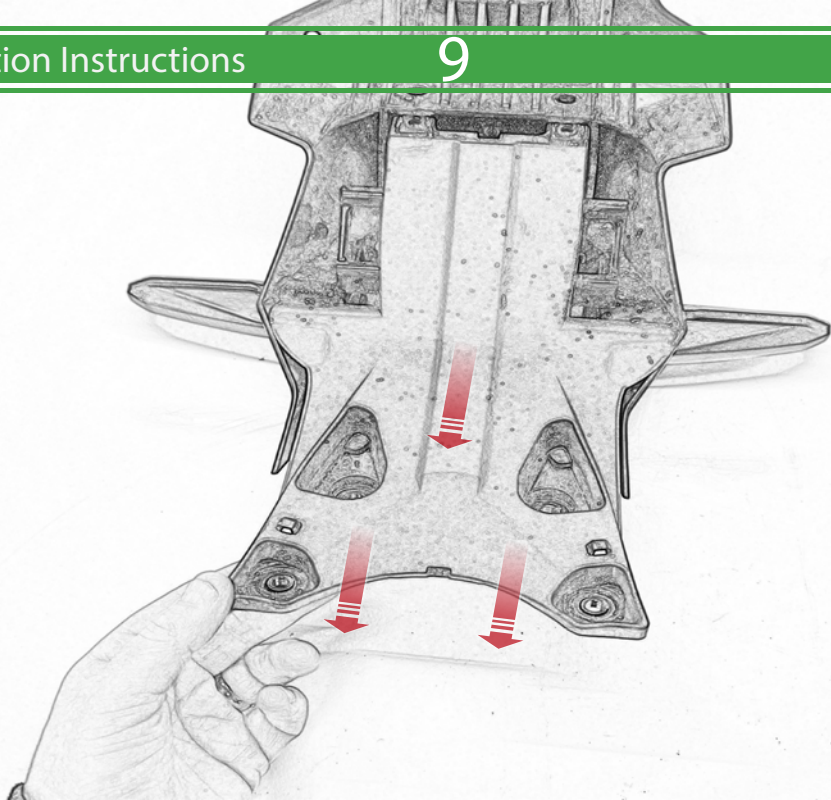

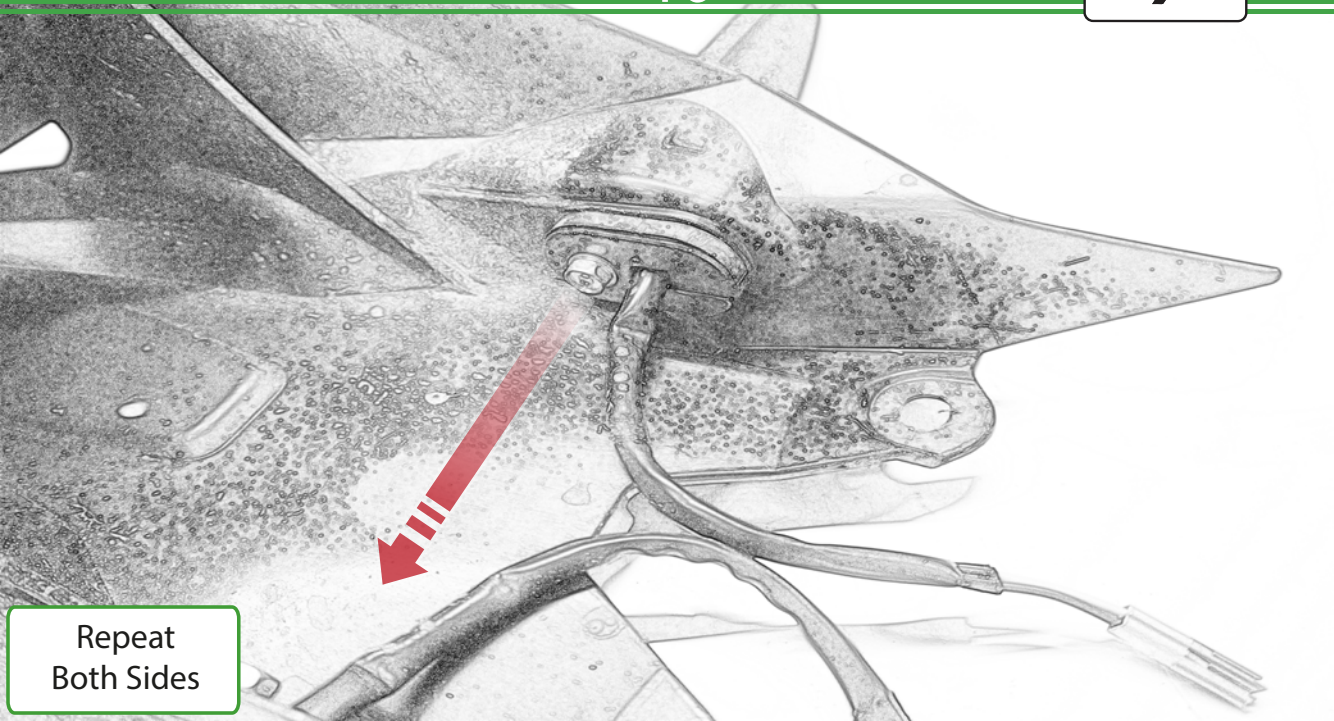

Repeat
Both Sides

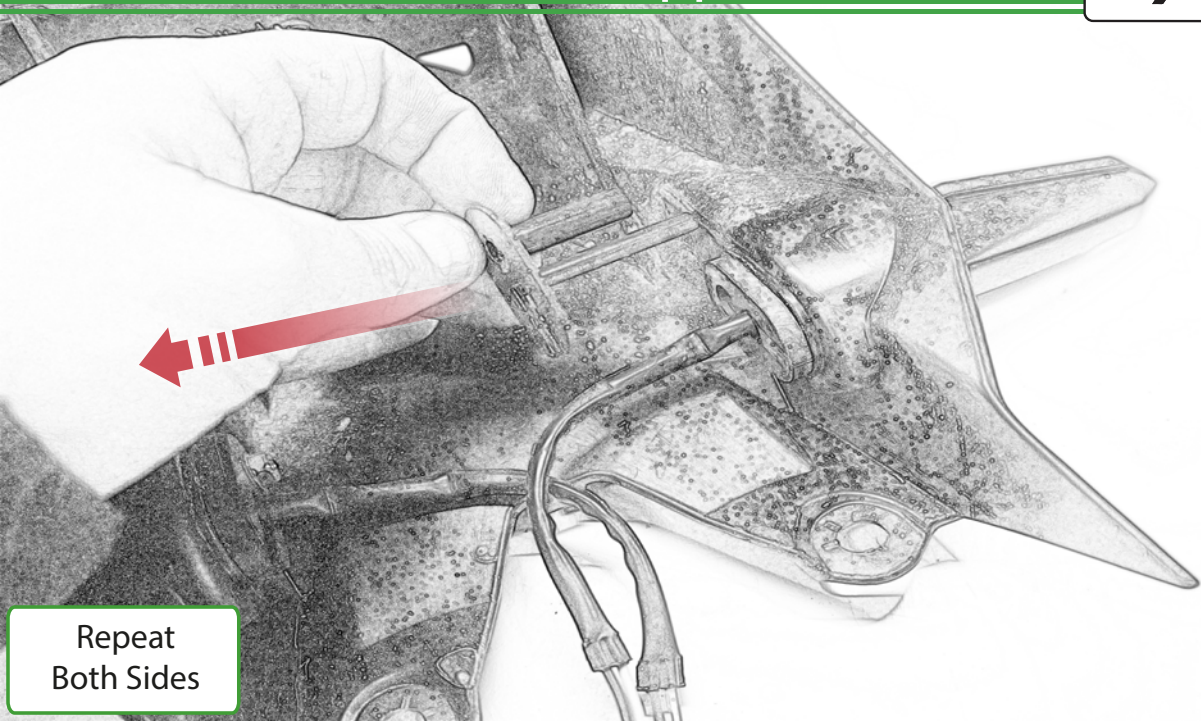

Repeat
Both Sides

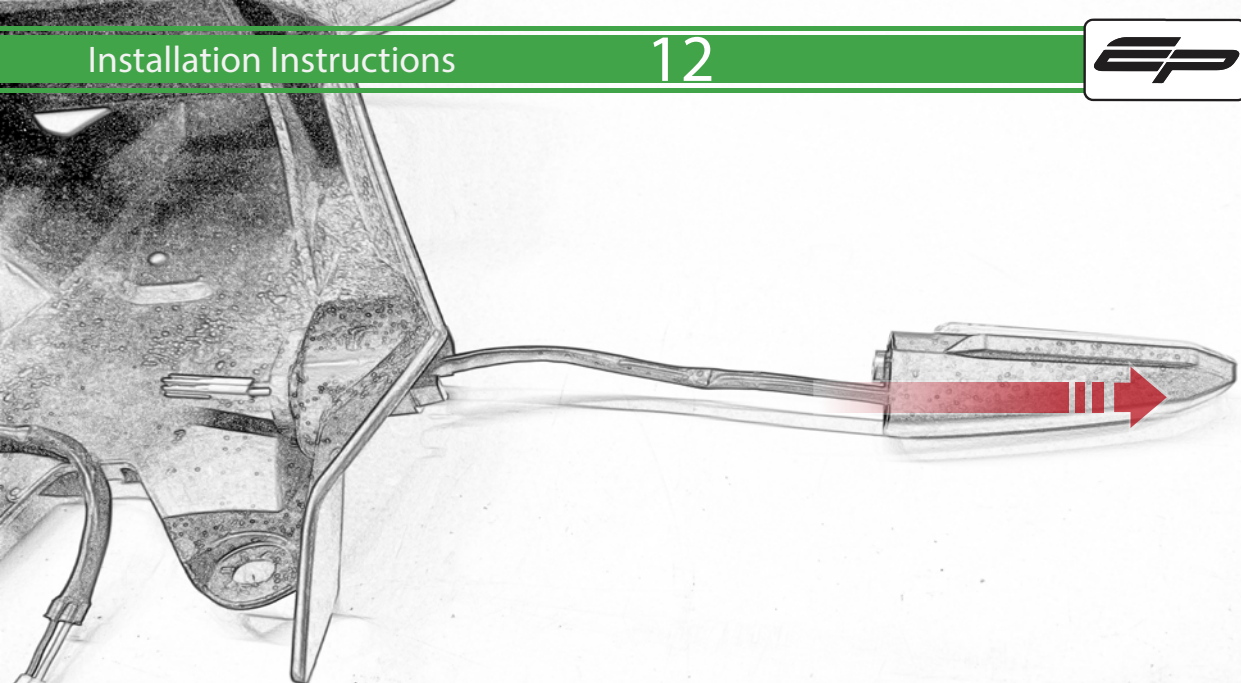

Repeat
Both Sides

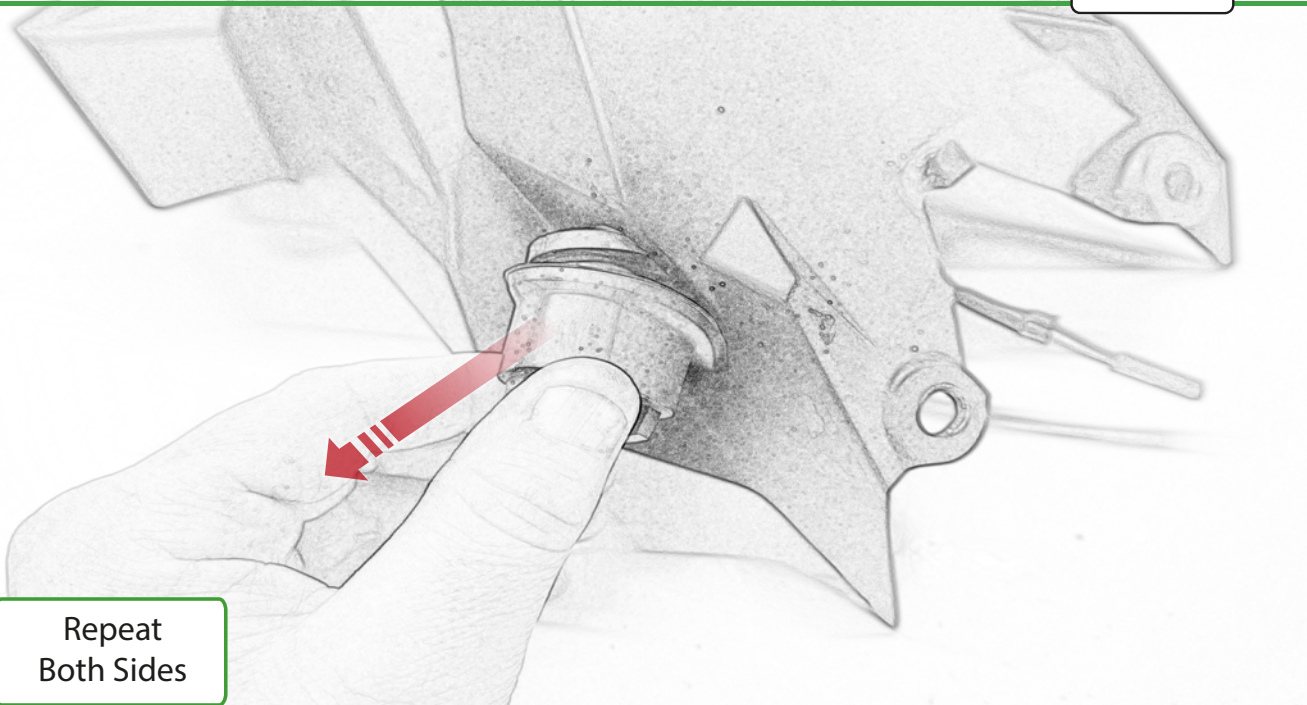

Repeat
Both Sides

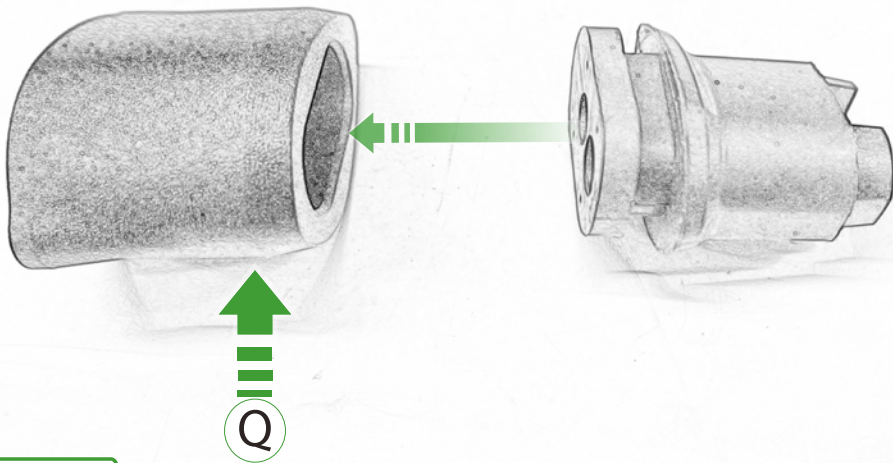

Repeat
Both Sides

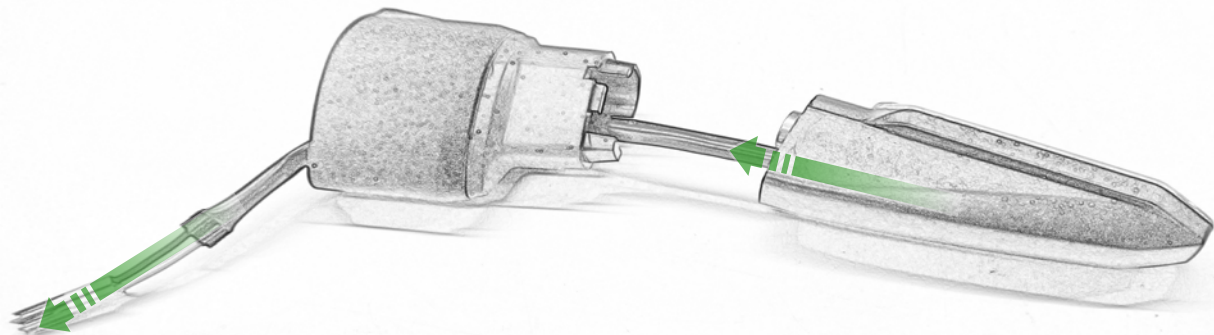

Repeat
Both Sides

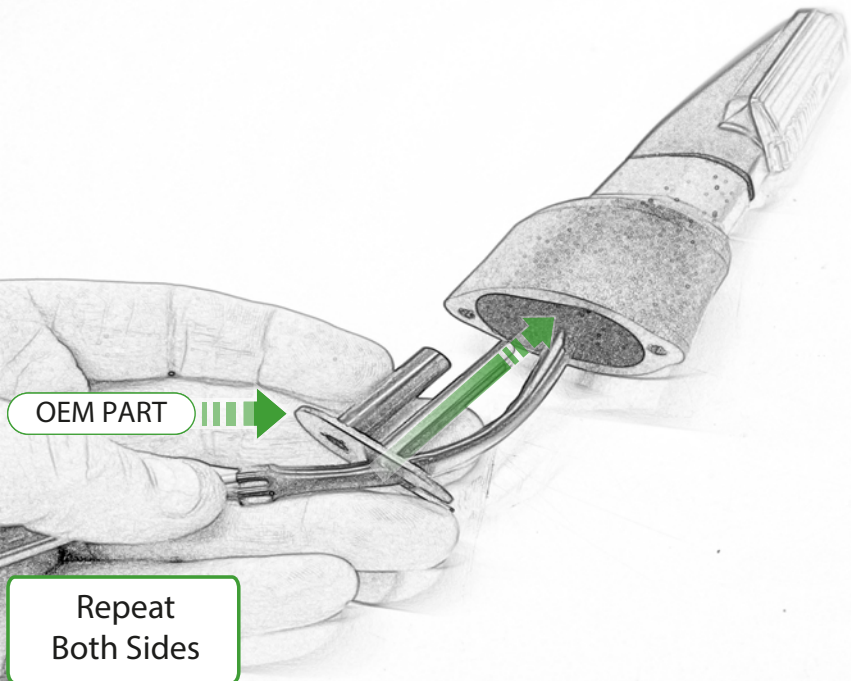

OEM PART

Repeat
Both Sides



OEM PART

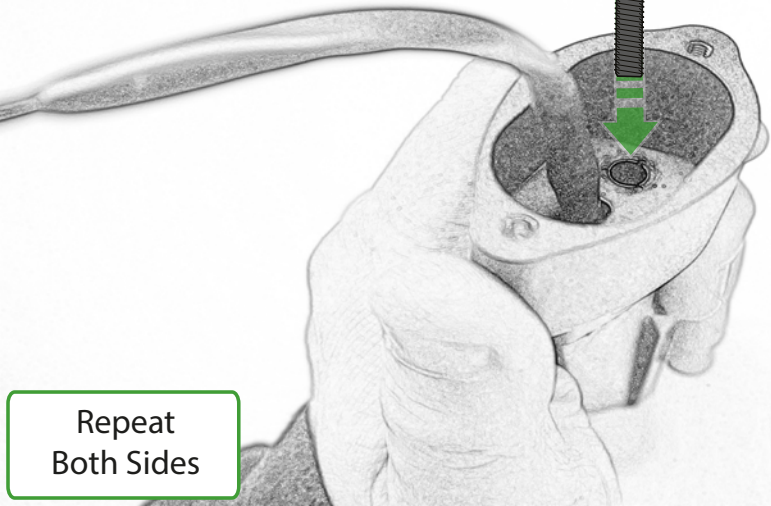

Repeat
Both Sides

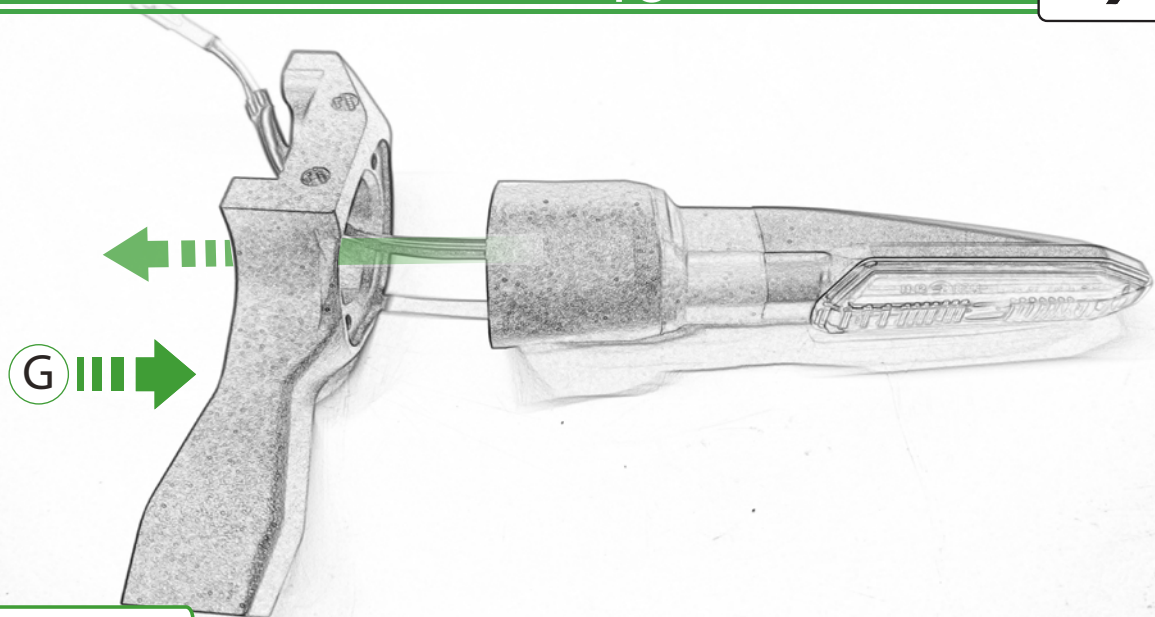

Repeat
Both Sides

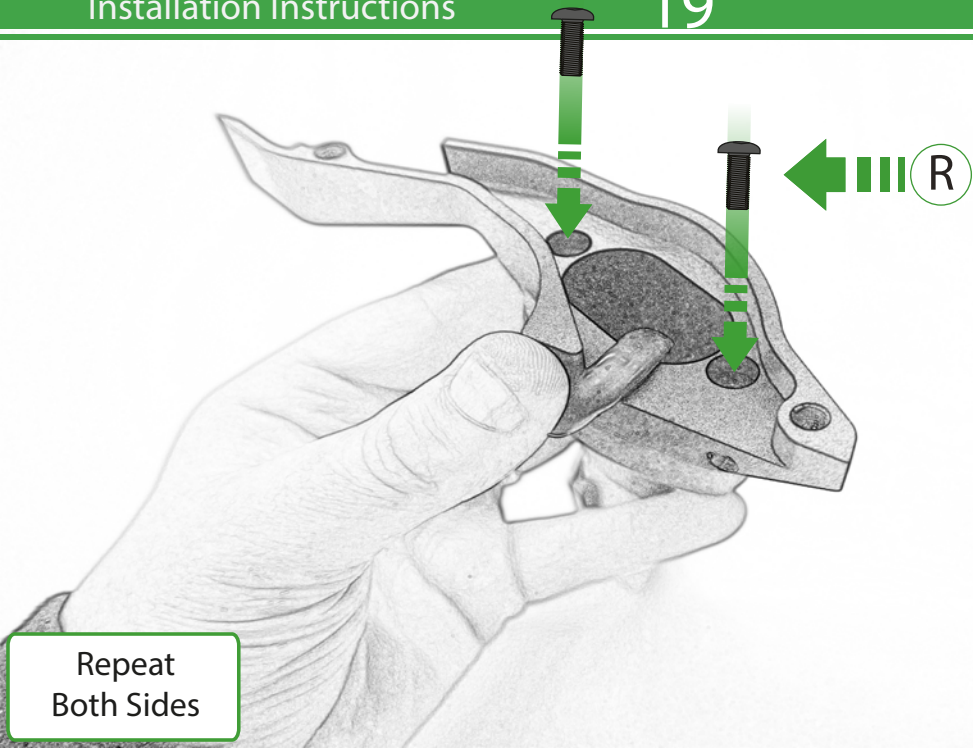

Repeat
Both Sides

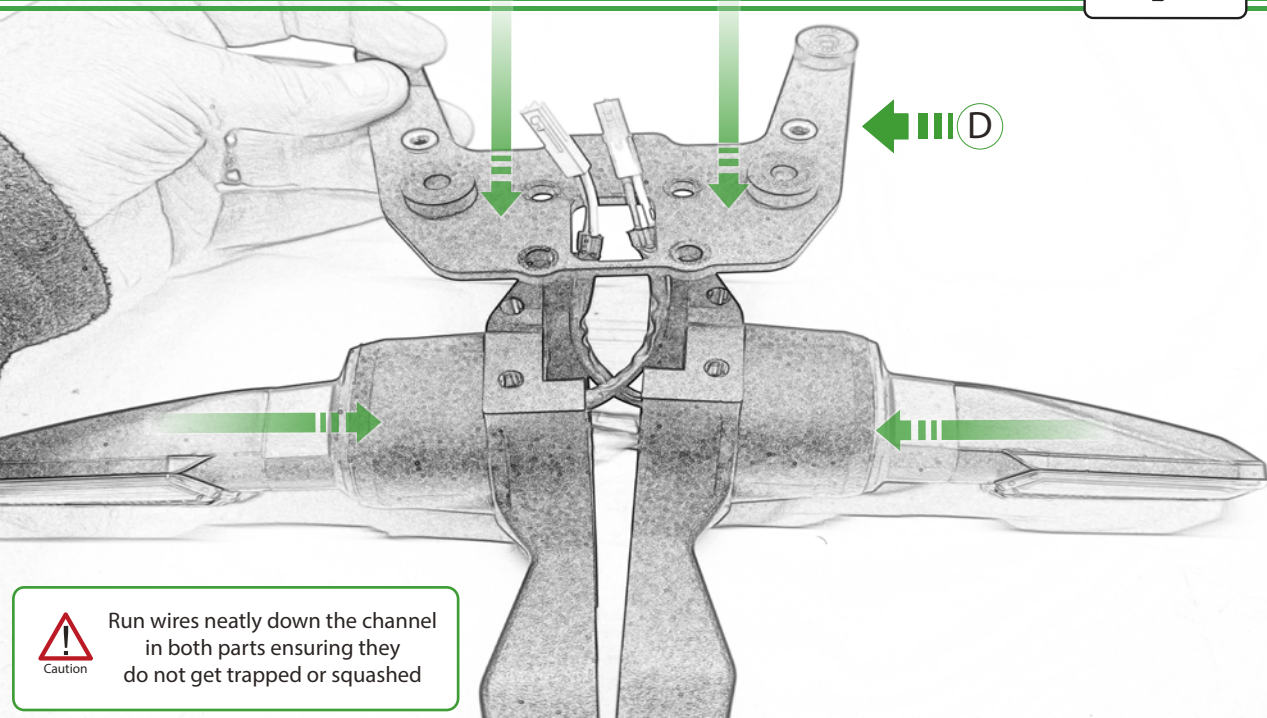

Caution

Run wires neatly down the channel in both parts ensuring they do not get trapped or squashed

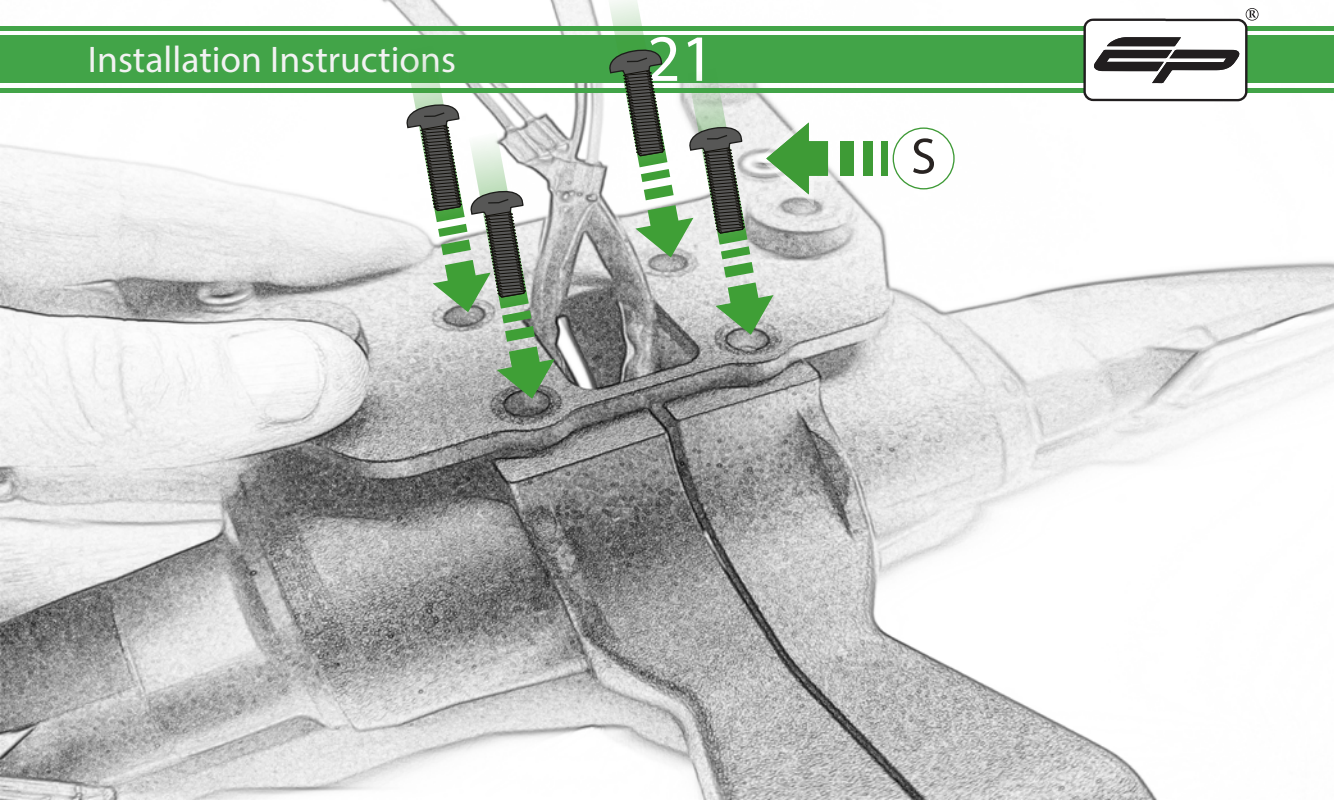

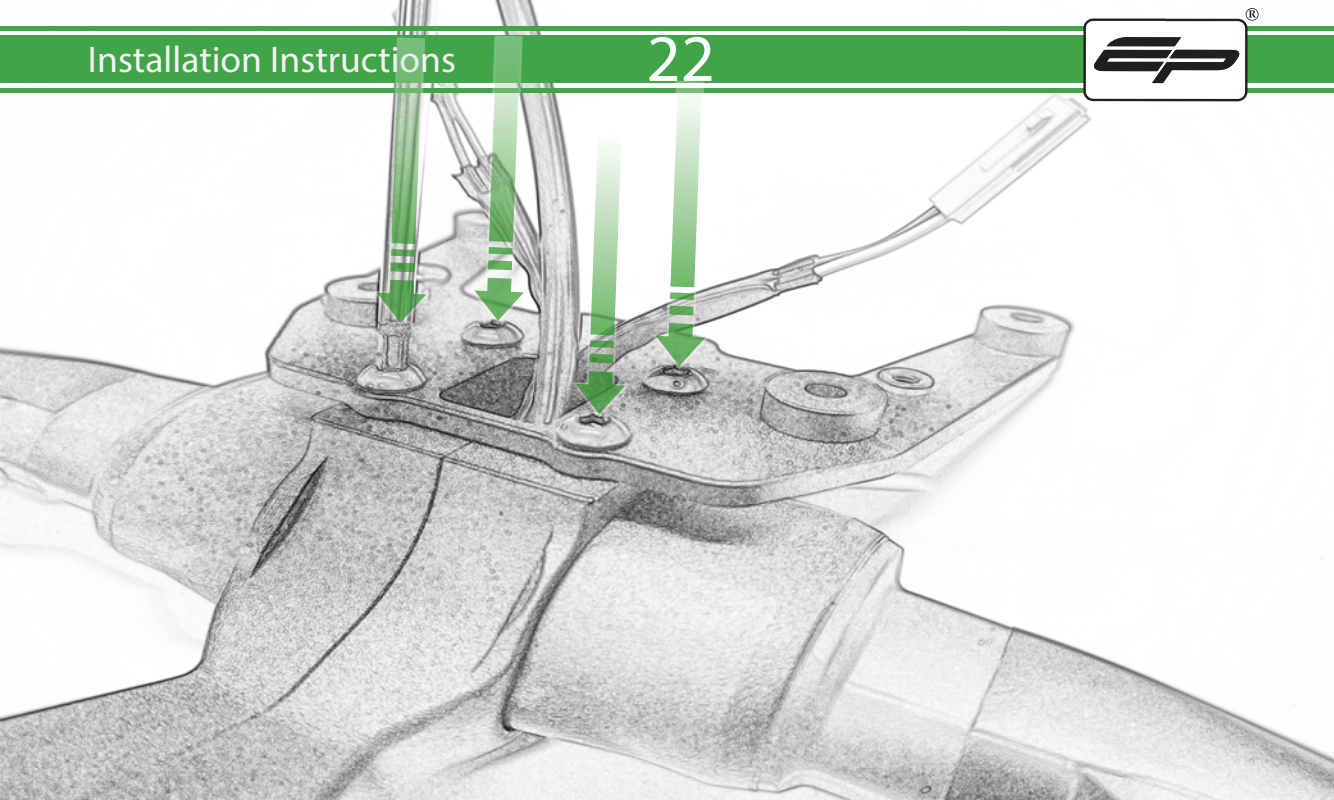

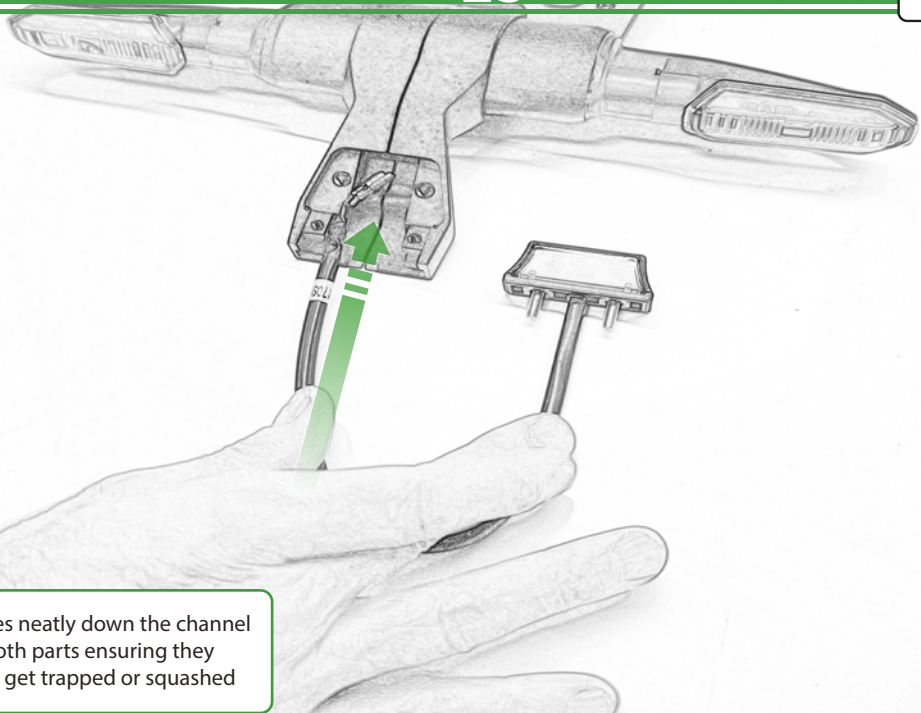

Caution

Run wires neatly down the channel in both parts ensuring they do not get trapped or squashed

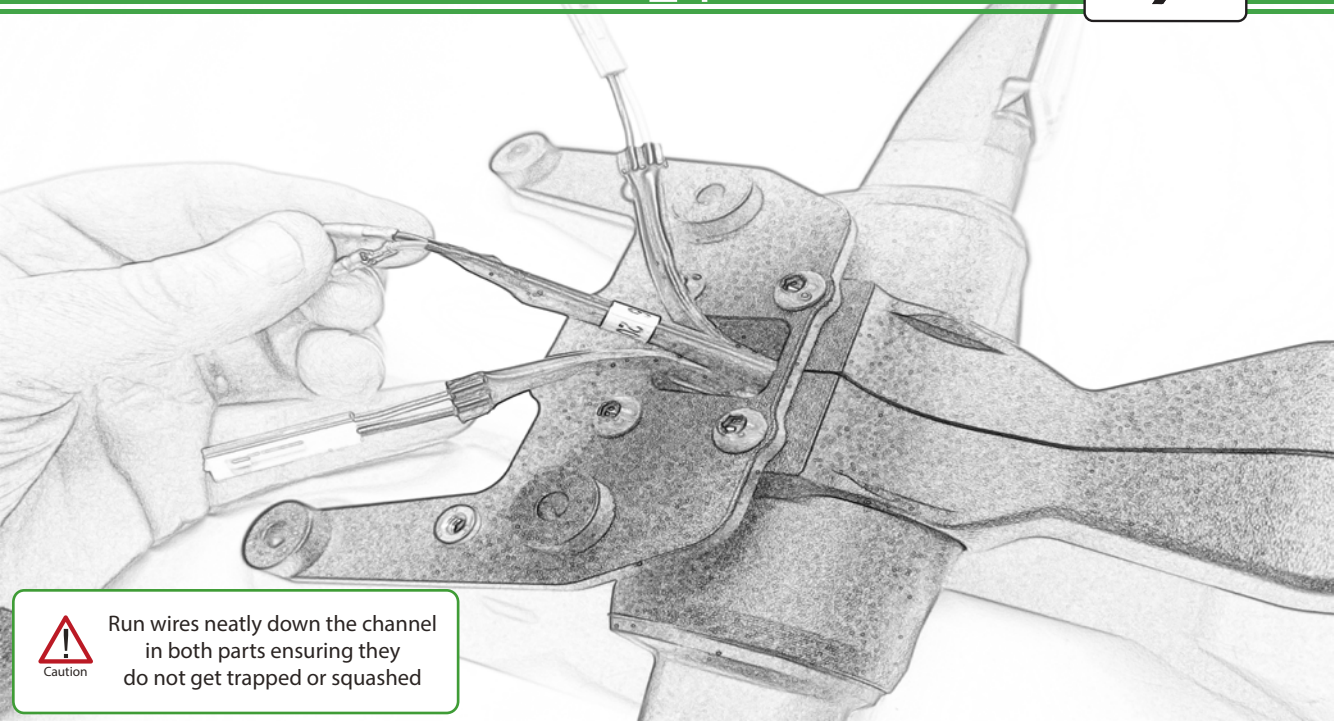

Caution

Run wires neatly down the channel in both parts ensuring they do not get trapped or squashed

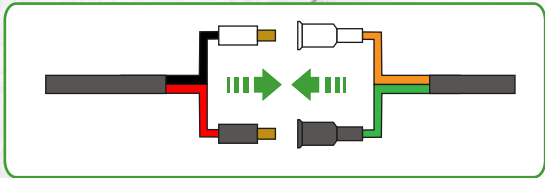
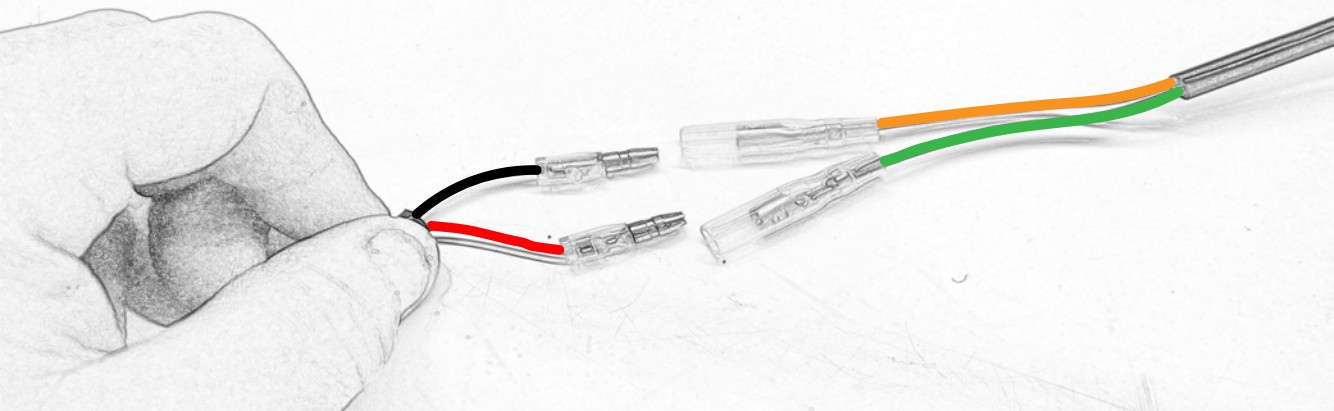

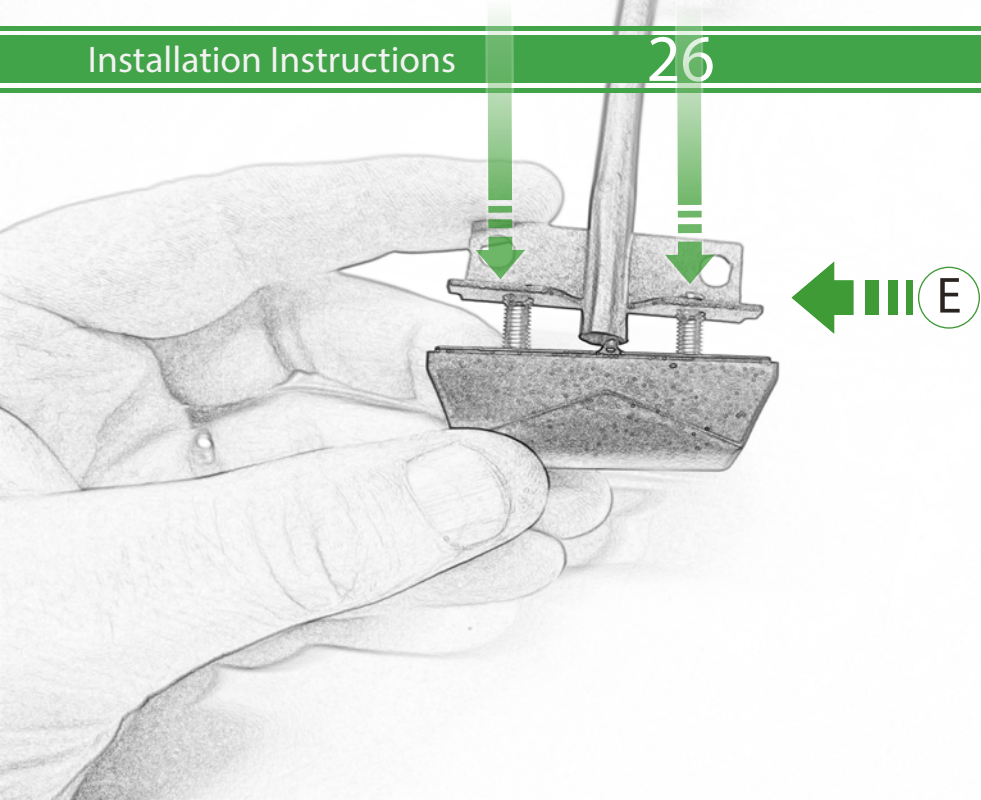

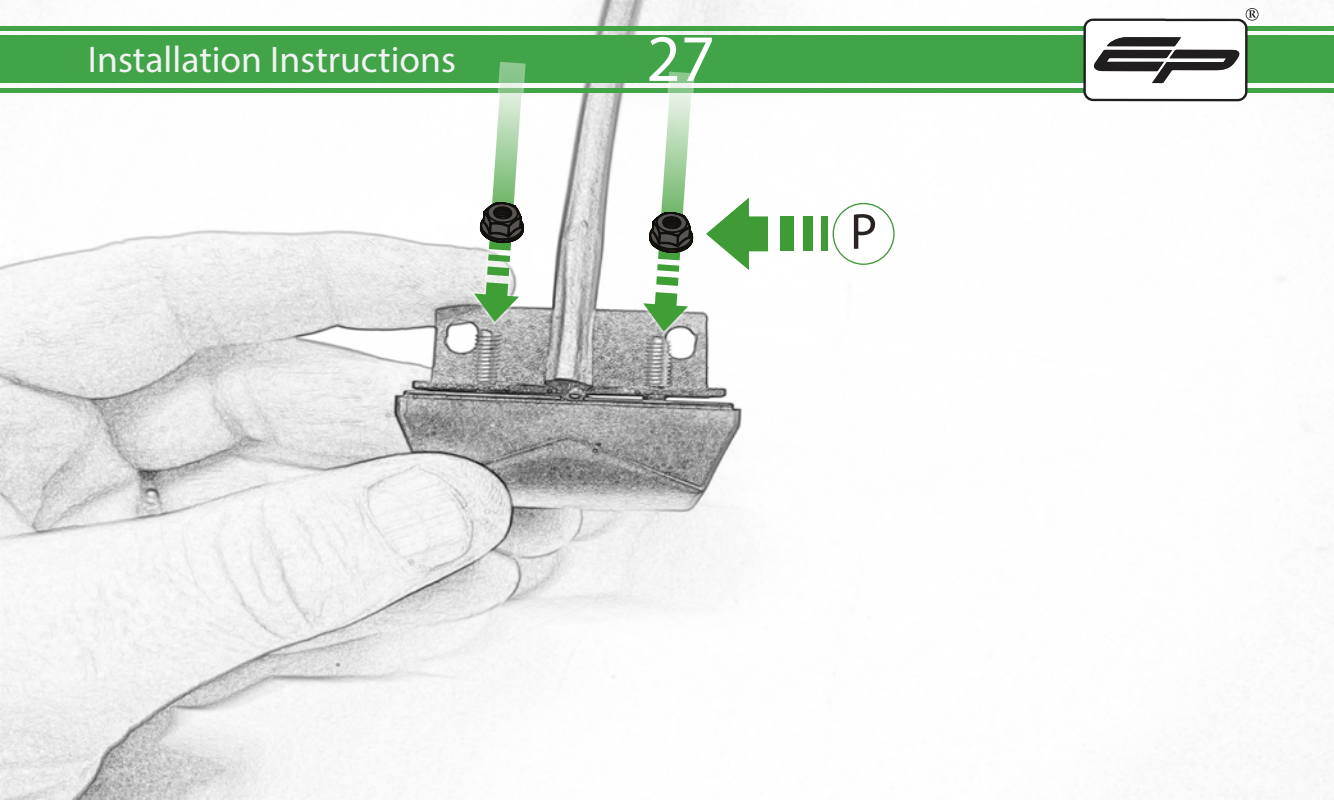

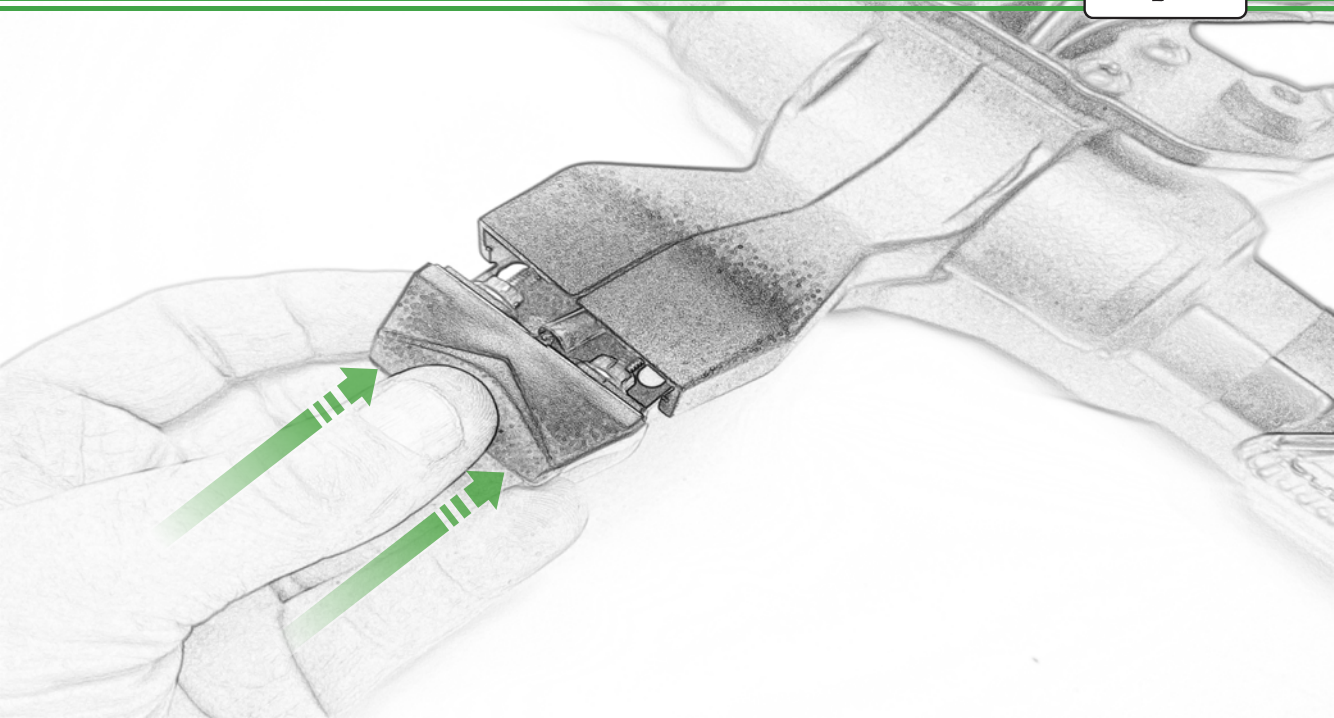

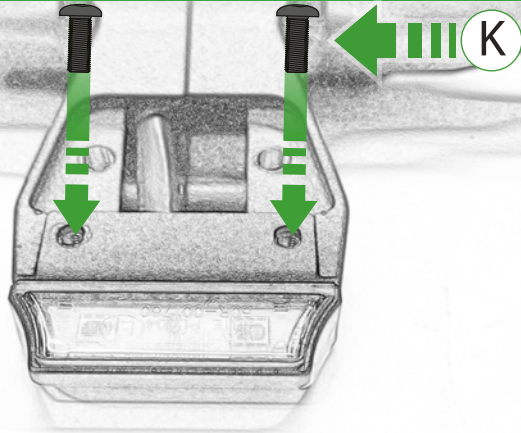

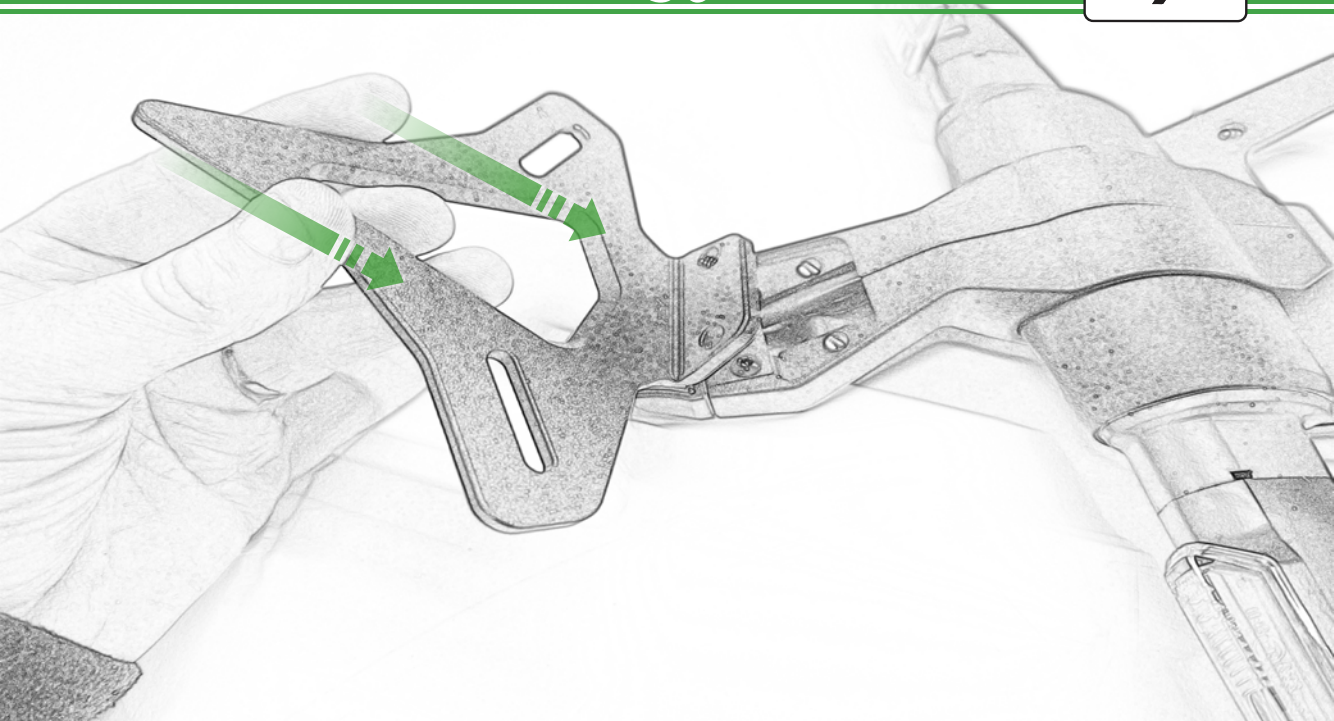

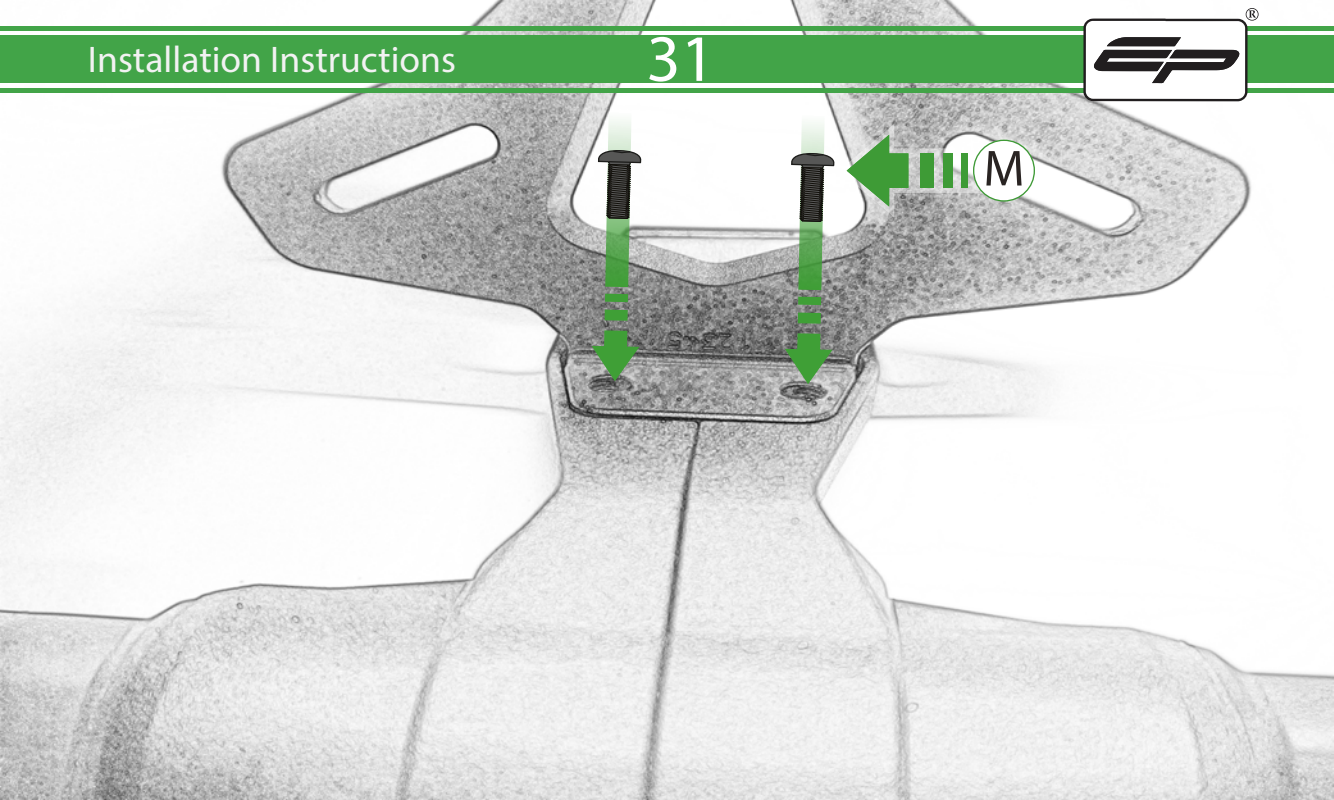

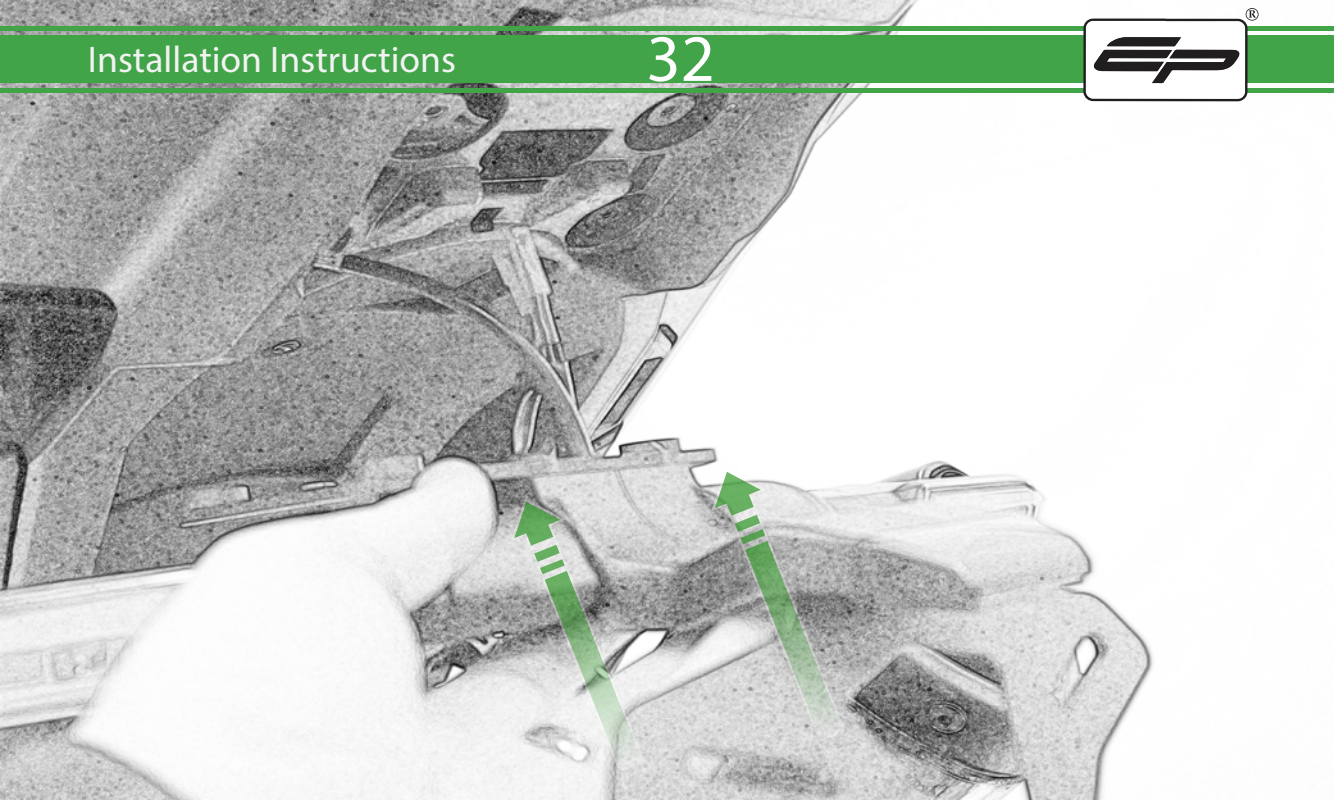

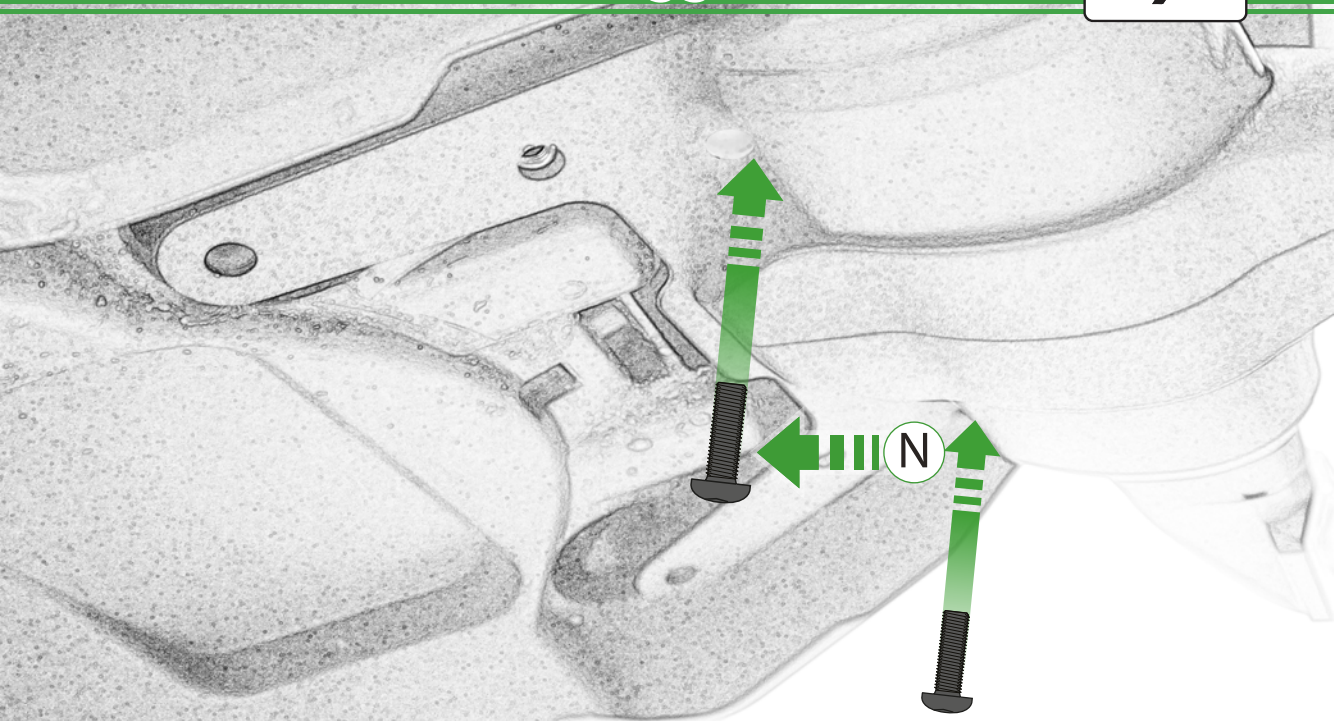

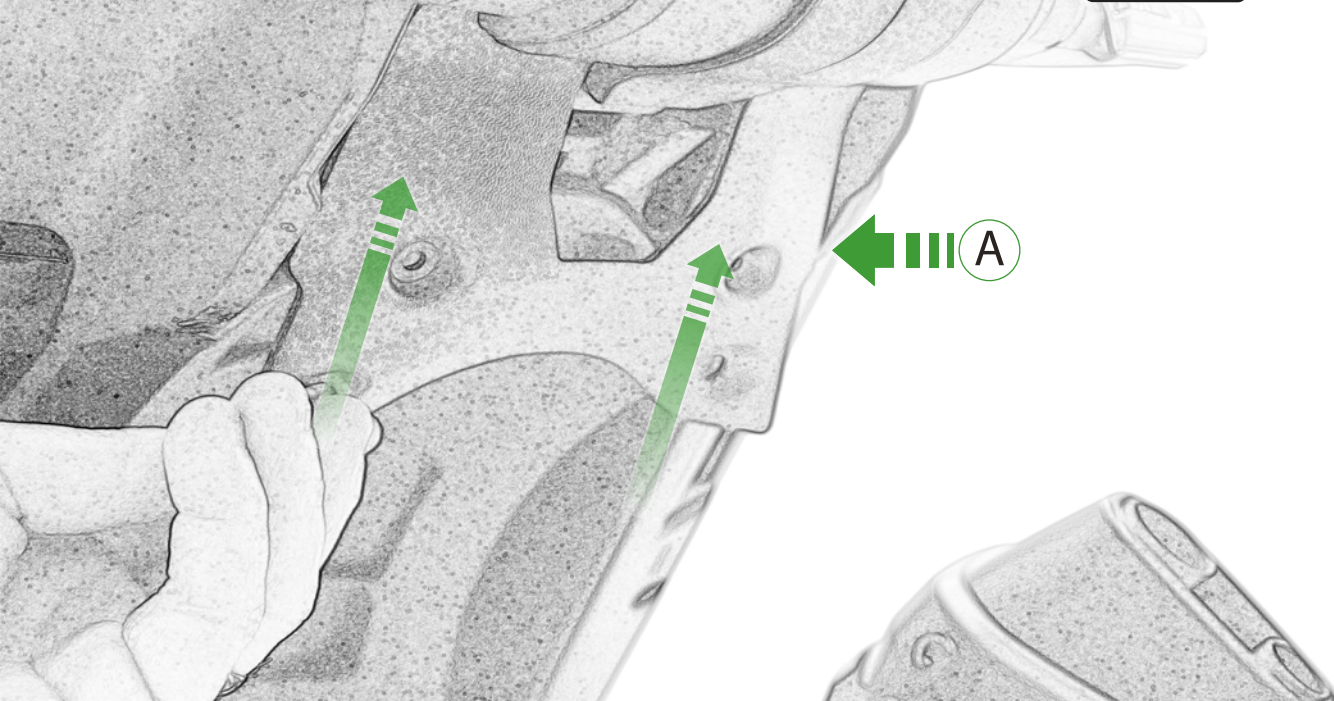

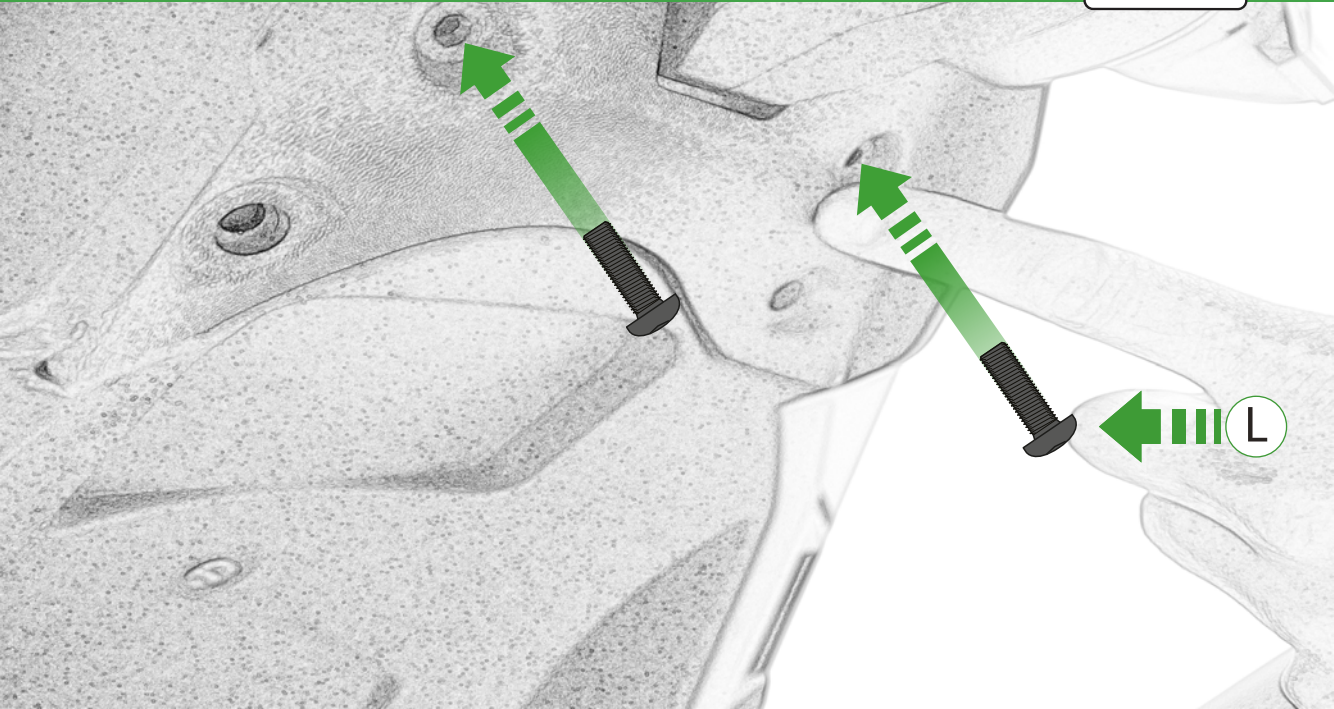

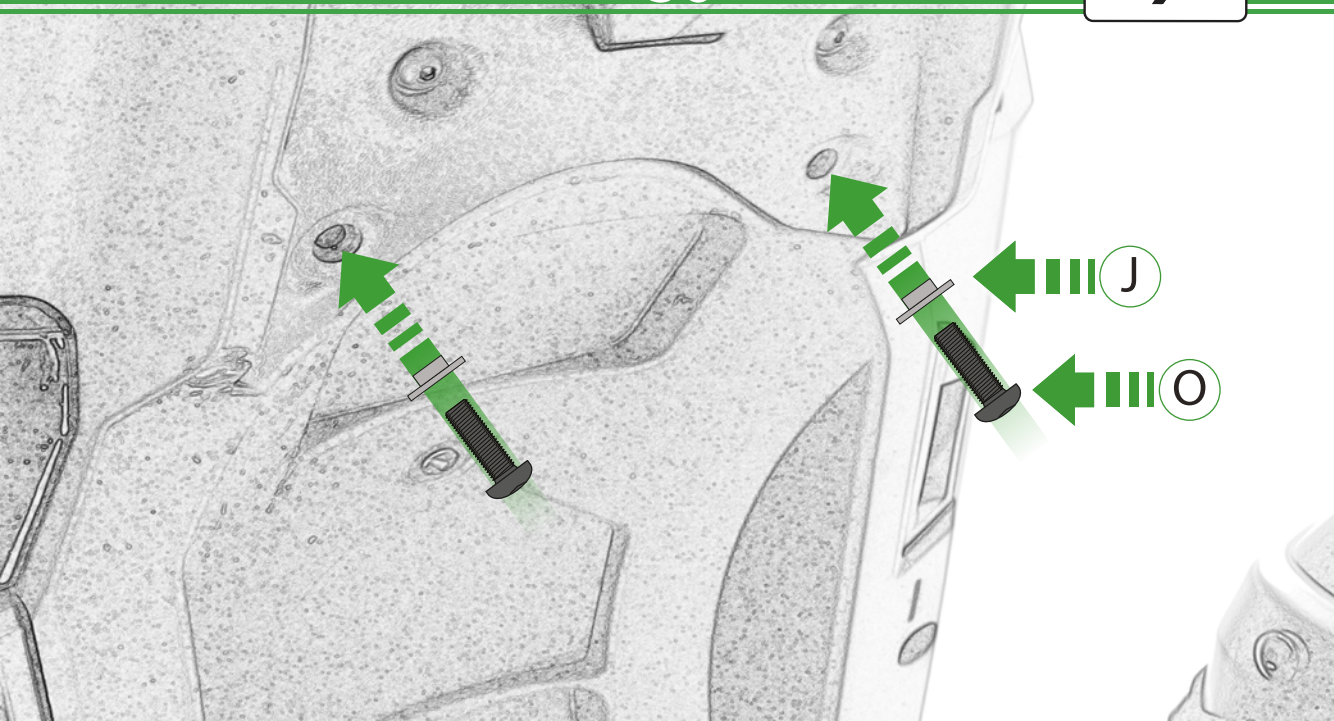

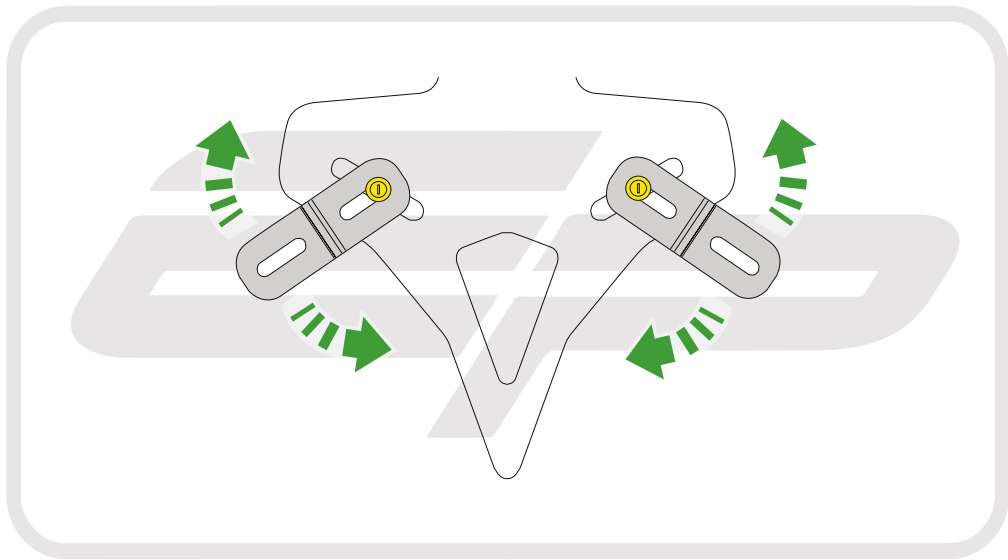

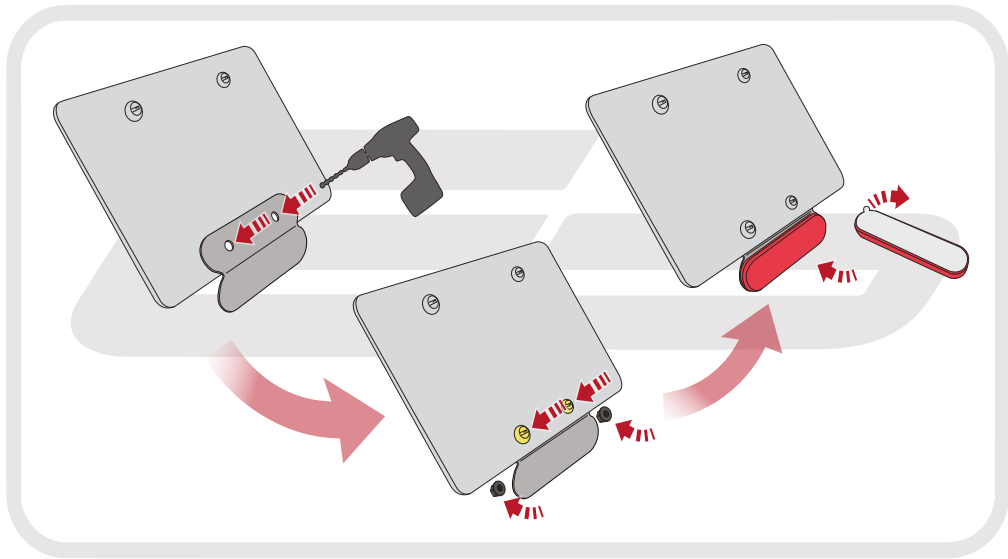



ESSENTIAL CHECKS

After installation of your tail tidy ensure that the licence plate does not contact the rear tyre when suspension is fully compressed.

Ensure all electrics including indicators, tail light, brake light and licence plate light lights are working correctly before riding the motorcycle.

It is recommended that periodic inspections are made to ensure that all fixings are fully tightend.



EVOTECH®
P E R F O R M A N C E

www.evotech-performance.com