



EVOTECH®
P E R F O R M A N C E

www.evotech-performance.com

Suzuki GSX-S1000 GT
SP Connect Sat Nav Mount



Kit Contents

- Ⓐ 1 x M6 x 16 Countersunk Screw
- Ⓑ 1 x Pivot Plate
- Ⓒ 1 x SP Connect Plate
- Ⓓ 1 x Spanner
- Ⓔ 1 x Anti Vibration Plate Adaptor
- Ⓕ 2 x P-clips (No.1)
- Ⓖ 2 x P-clips (No.2)
- Ⓗ 2 x P-clips (No.3)
- Ⓘ 2 x P-clips (No.4)
- Ⓙ 2 x Lobe Screw
- Ⓚ 2 x Locking Washer
- Ⓛ 2 x M5 Black Washer
- Ⓜ 2 x M4 x 5mm Button Head Bolts
- Ⓝ 2 x M5 x 10mm Caphead Bolts
- Ⓞ 2 x M5 x 6mm Black Button Head Bolt
- Sub Kit
- ⒶⒶ 4 x M5 x 25 Silver Button Head Bolt
- ⒷⒷ 4 x Top Hat Spacer

PERFORMANCE

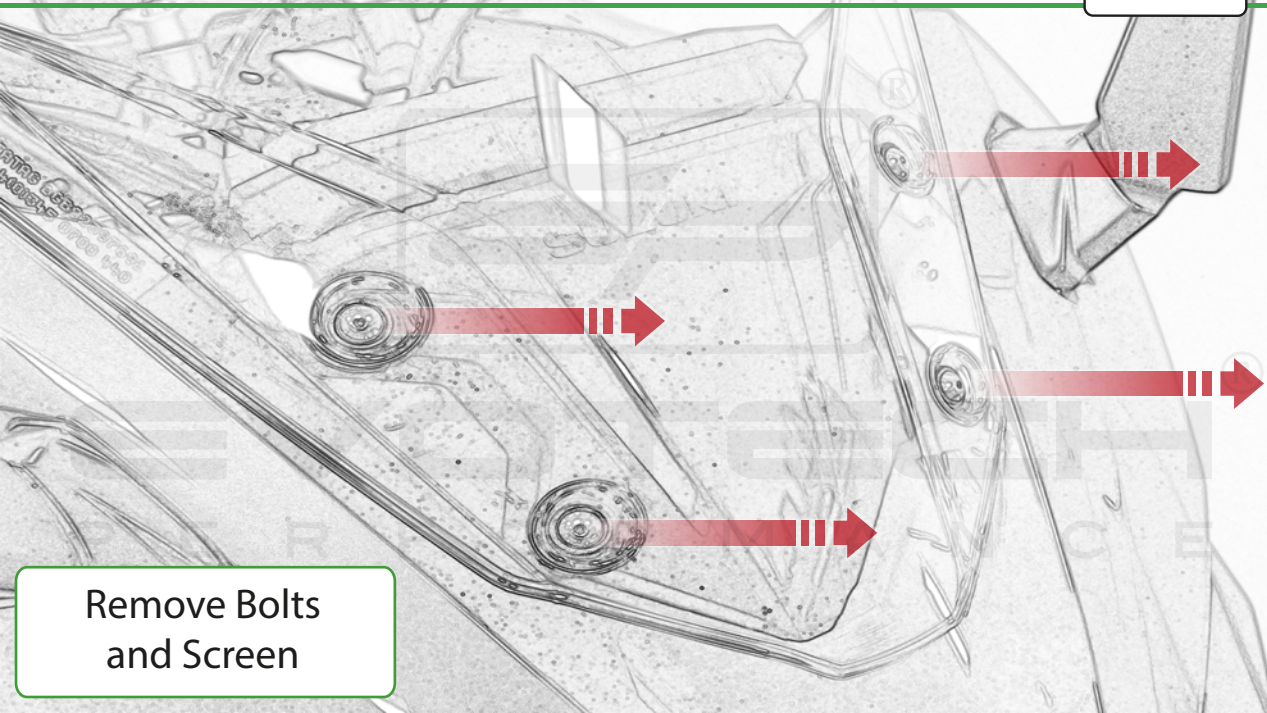

Remove Bolts
and Screen



Transfer Screen
Rubber Bungs



EVOLTECH[®]
PERFORMANCE

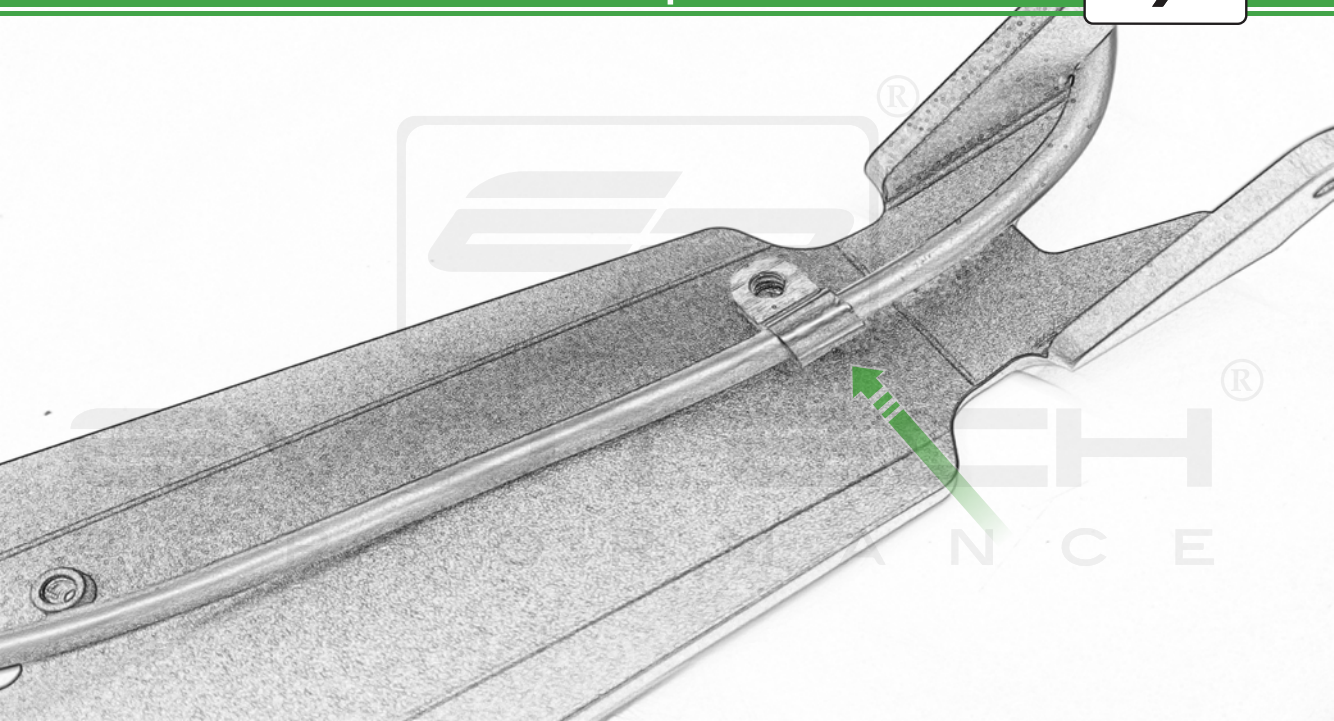

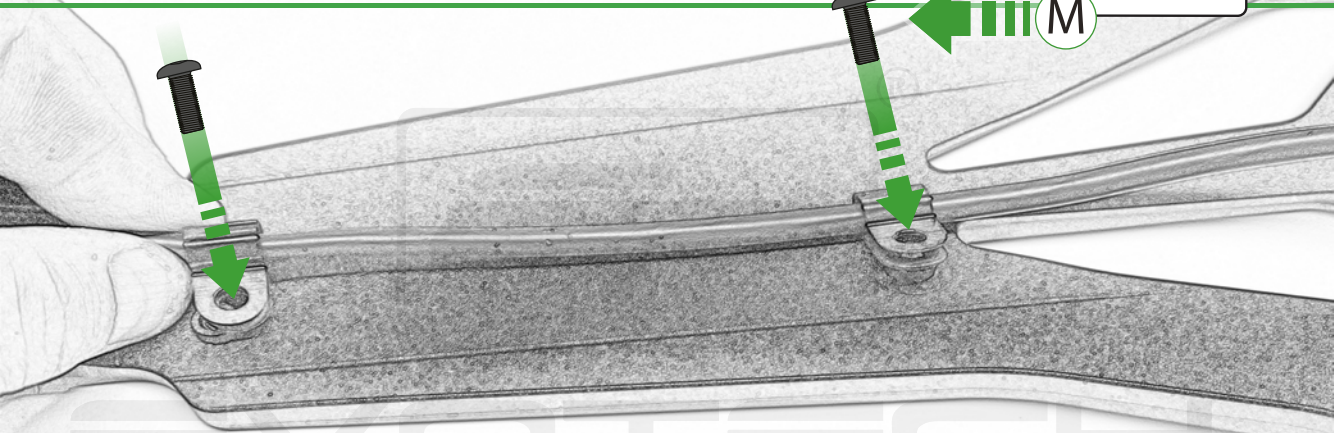

EVO TECH
P E R F O R M A N C E



SP Connect
Standard Mount



SP Connect
Anti Vibration Mount



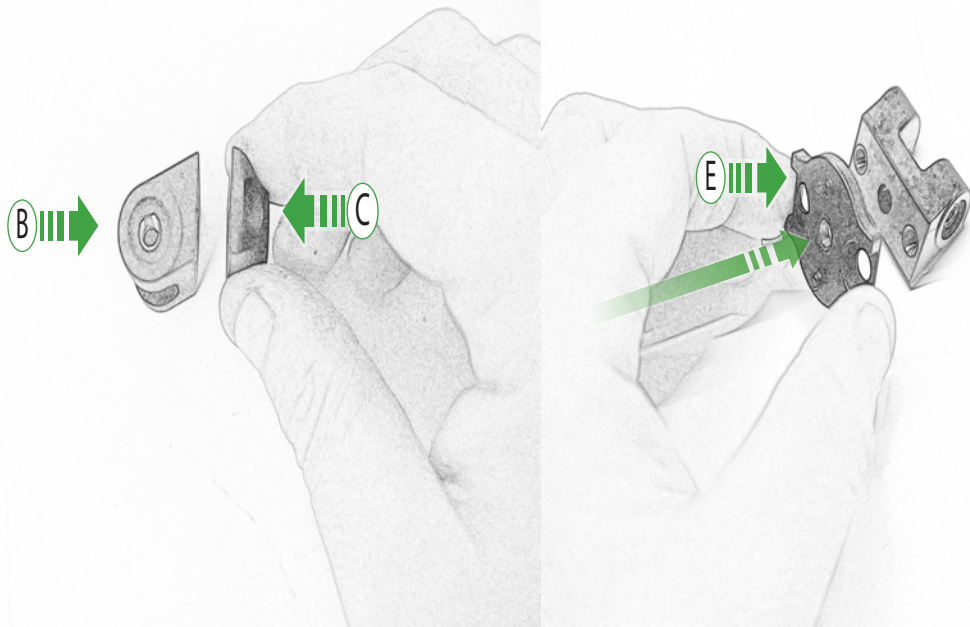

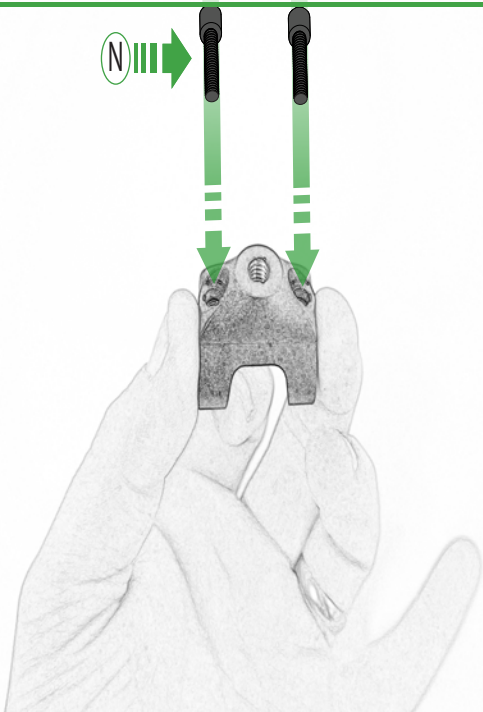

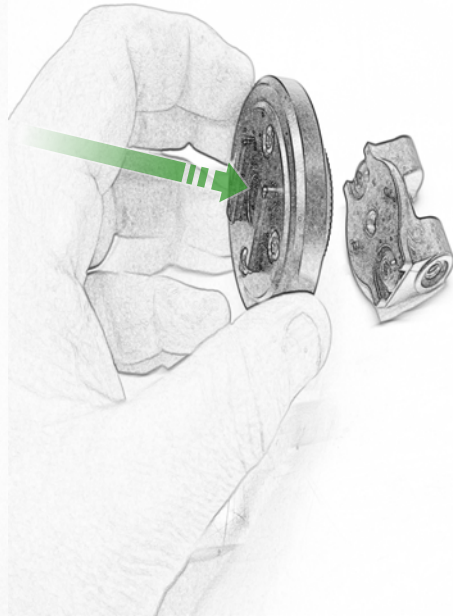
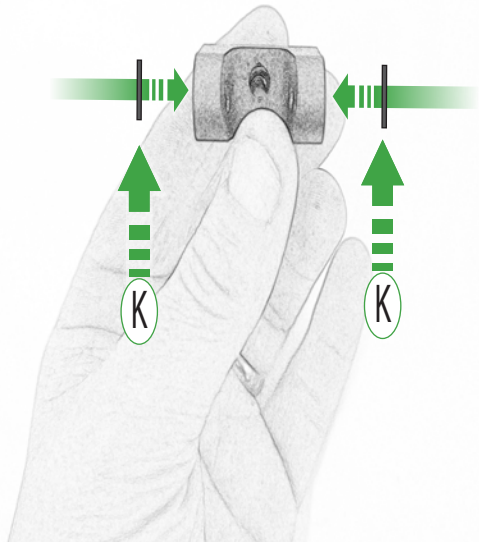



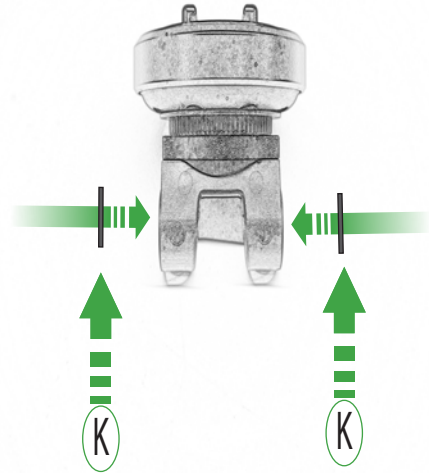
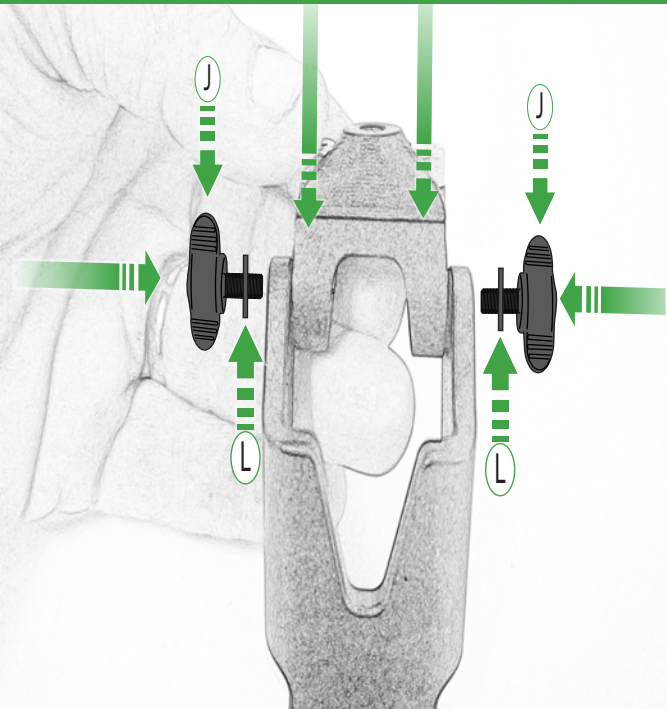

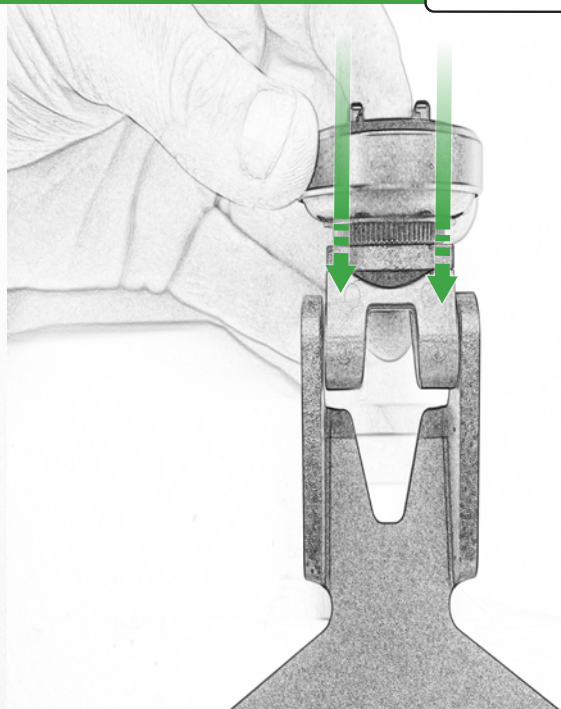

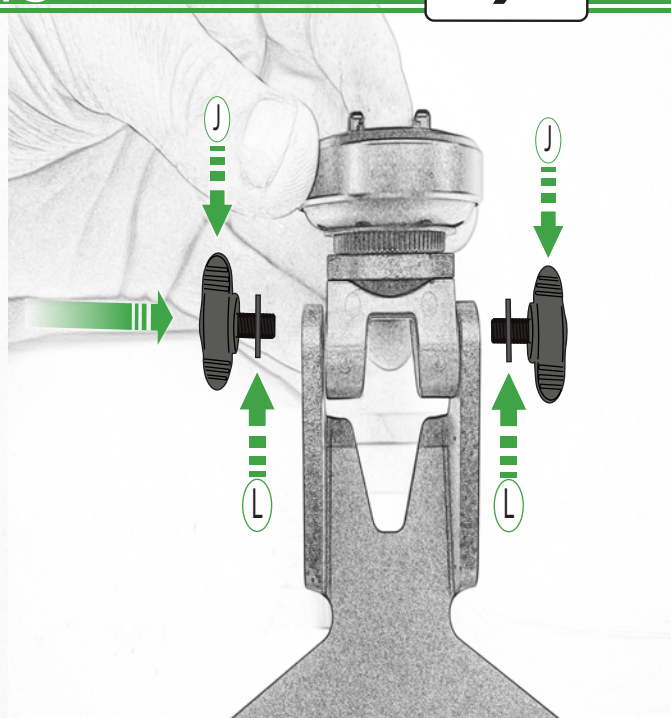
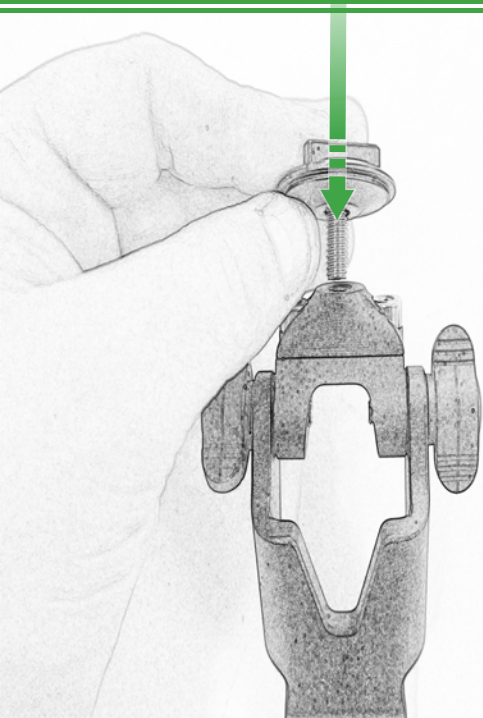

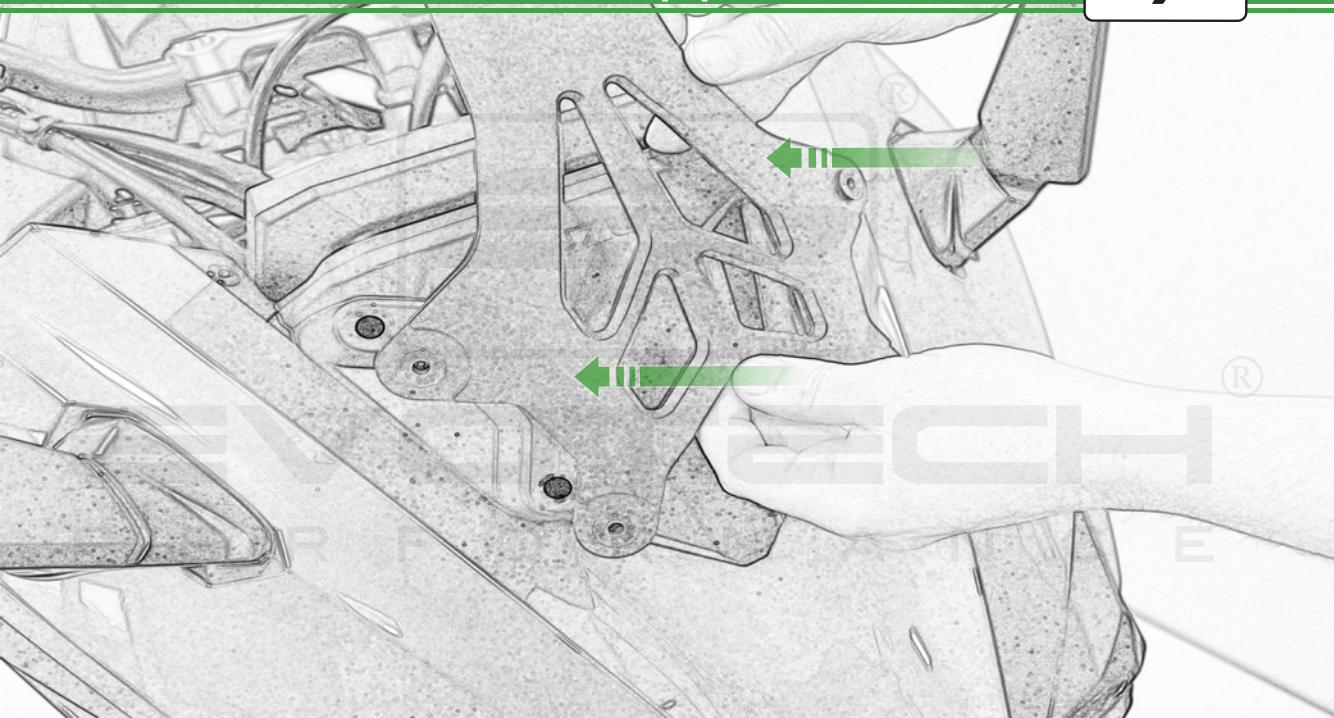



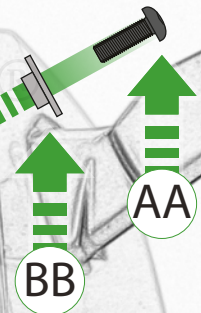
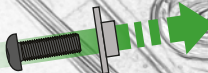
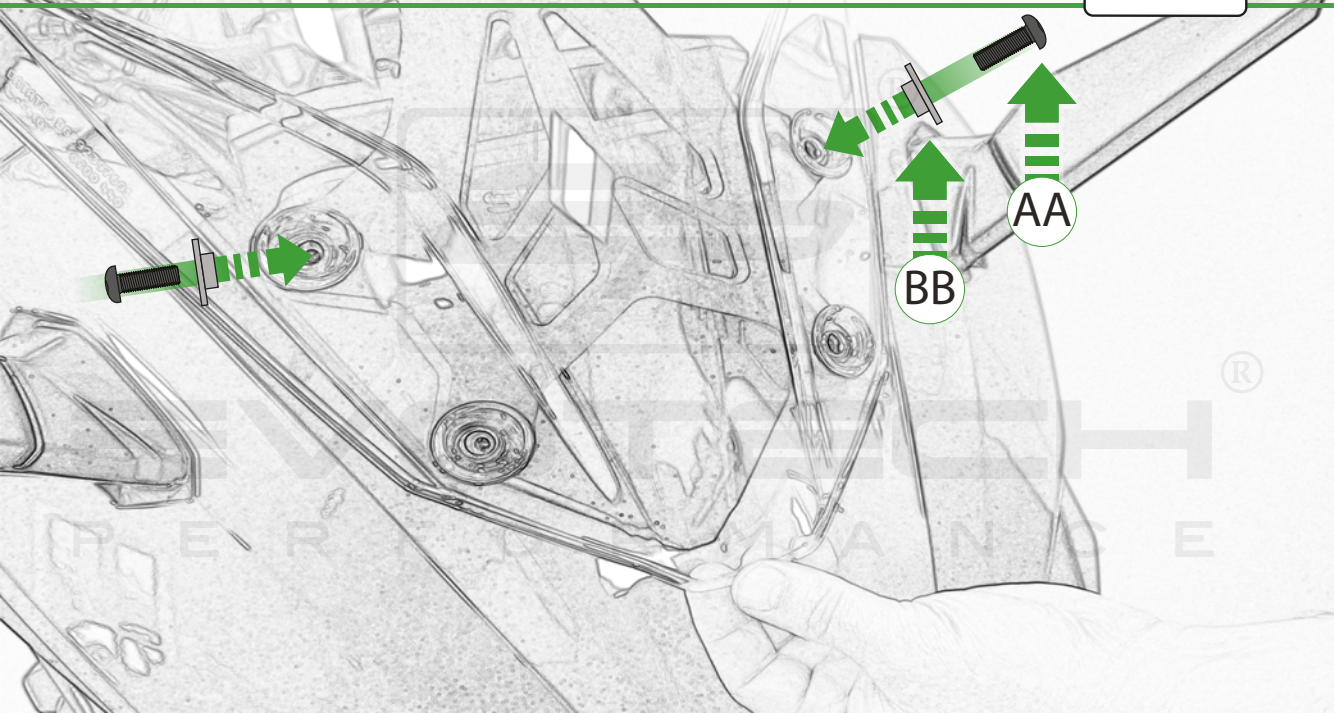



ESSENTIAL CHECKS



It is recommended that periodic inspections are made to ensure that all bolts are tightened to the specified torque settings.

Should the bike be involved in an accident a thorough inspection should be made and any components that have taken an impact, no matter how small, be replaced



EVOTECH®
P E R F O R M A N C E

www.evotech-performance.com