

EVOTECH®
P E R F O R M A N C E

www.evotech-performance.com

Honda CBR650R Quadlock Mount Installation Instruction



- Ⓐ 1 x Main Plate
- Ⓑ 1 x Pivot Plate
- Ⓒ 1 x Quad Lock Sub Bracket
- Ⓓ 1 x Quad Lock Mounting Bracket
- Ⓔ 2 x M5 x 8mm Black Button Head Bolts
- Ⓕ 2 x P-clips (No.1)
- Ⓖ 2 x P-clips (No.2)
- Ⓗ 2 x P-clips (No.3)
- Ⓘ 2 x P-clips (No.4)
- Ⓙ 2 x Lobe Screw
- Ⓚ 2 x Locking Washer
- Ⓛ 2 x M5 Black Washer
- Ⓜ 2 x M4 x 5mm Black Button Head Bolts
- ⒶⒶ 2 x M8 x 45mm Flange bolt

EVO TECH
P E R F O R M A N C E

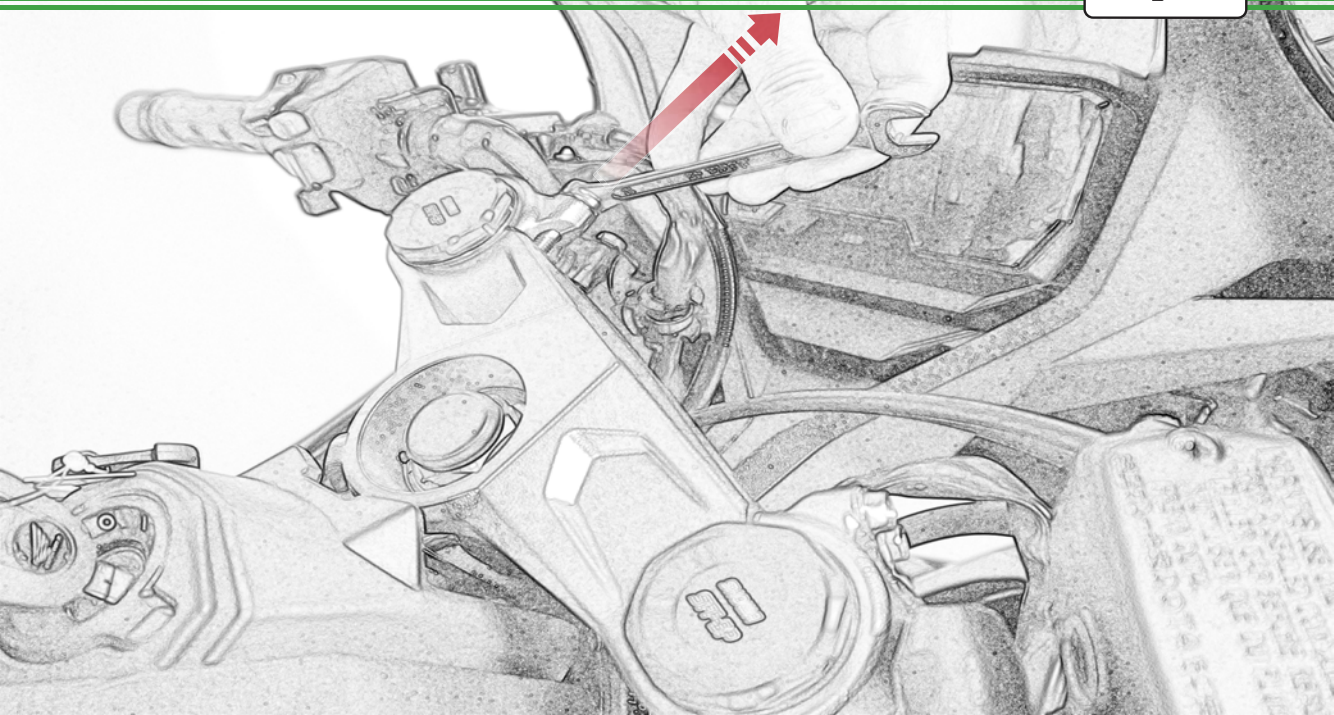

Installation Instructions

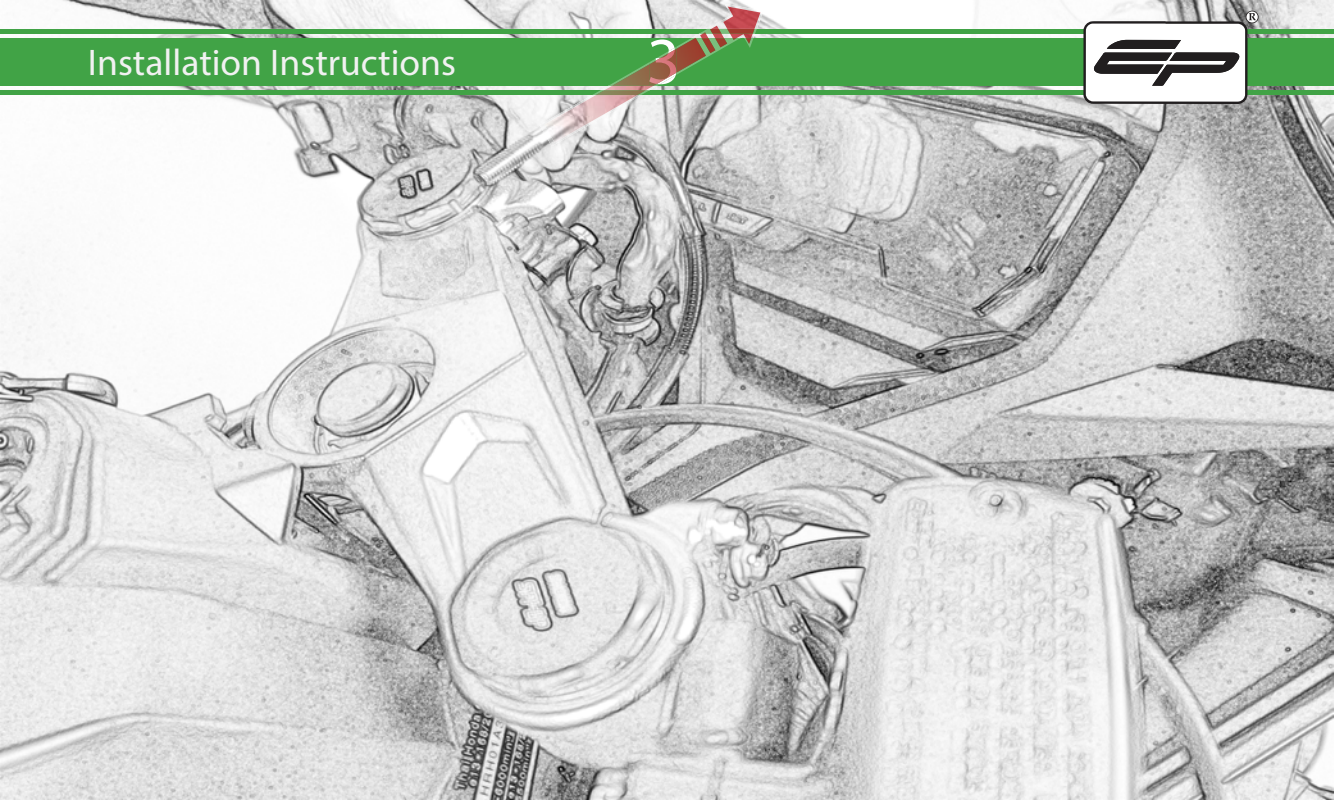

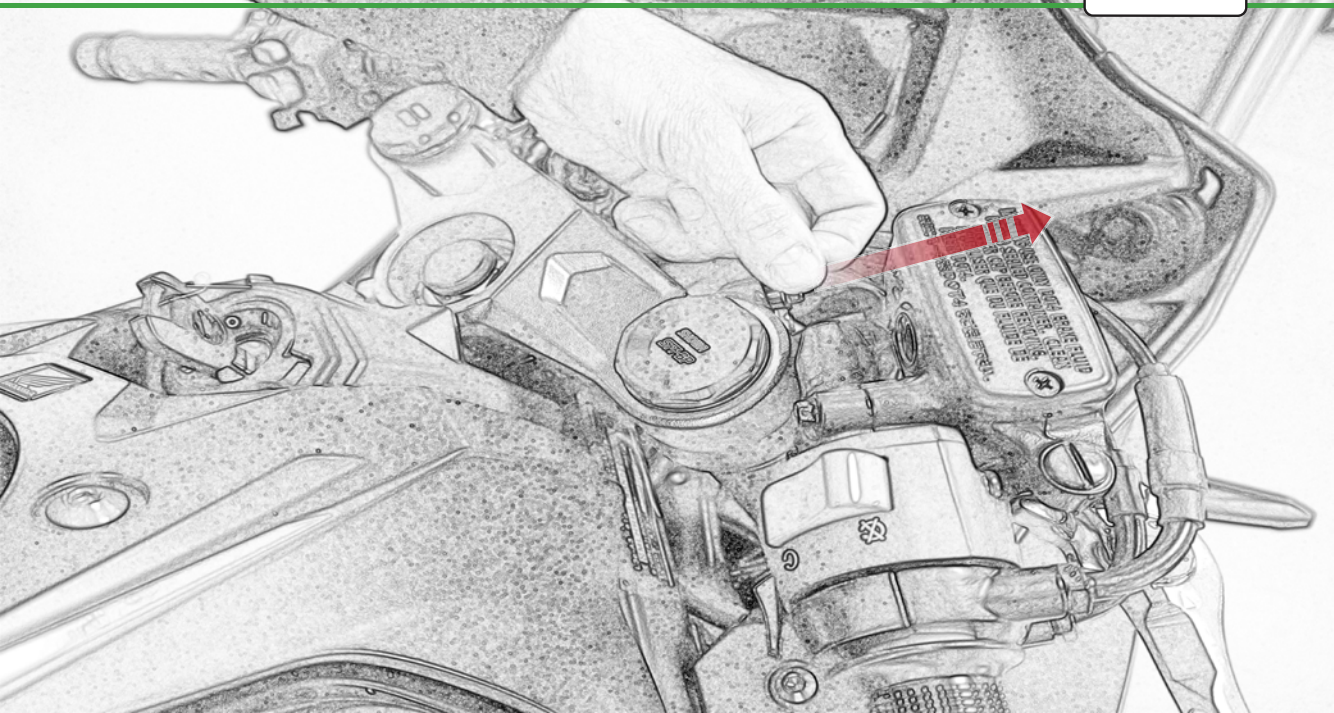

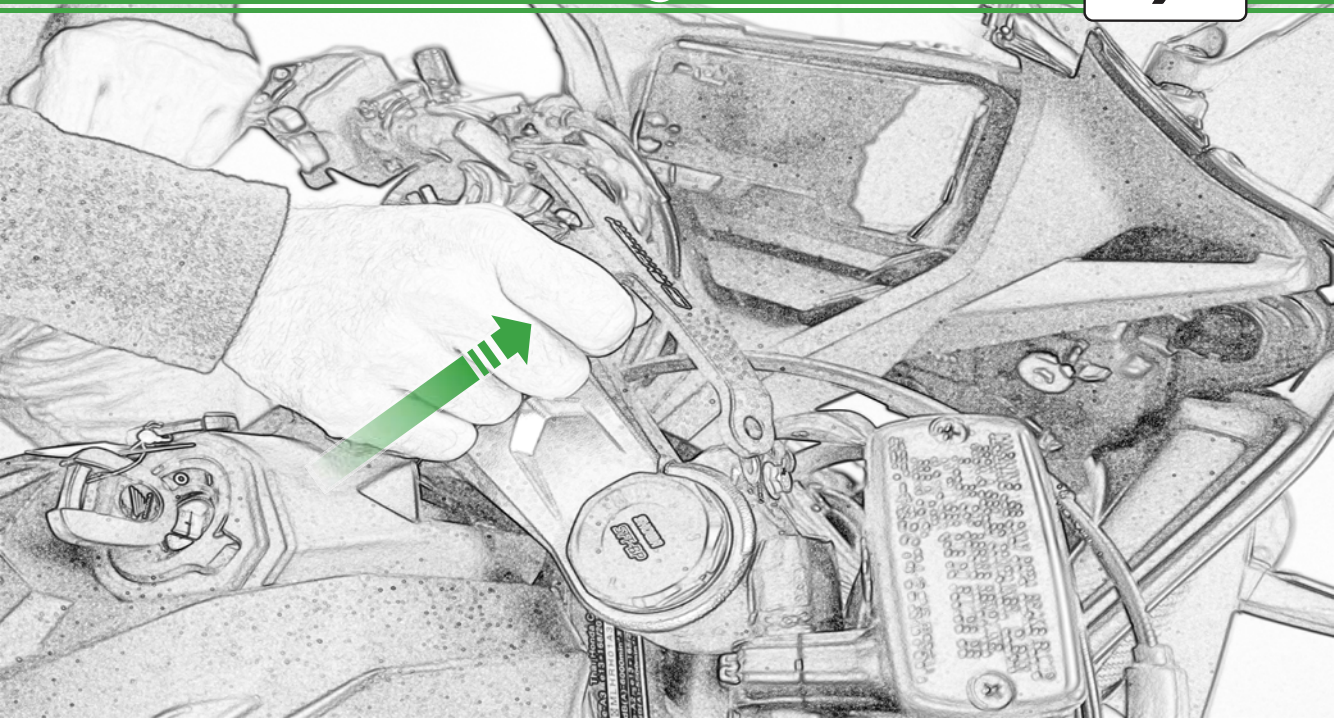

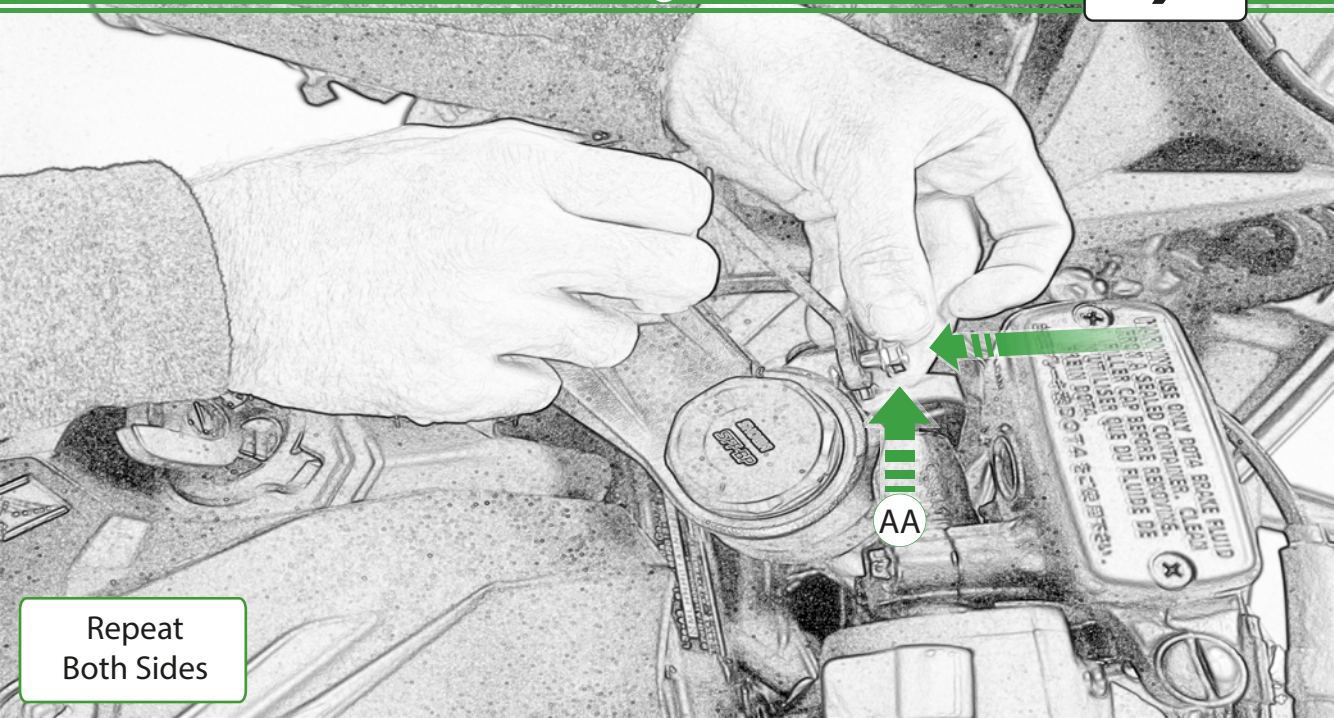

Repeat
Both Sides

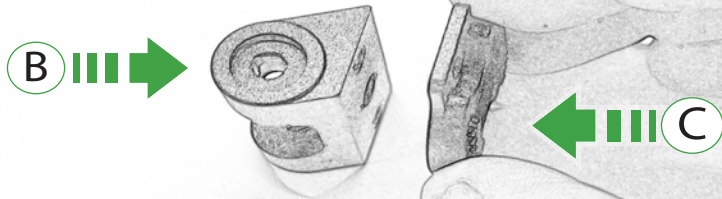

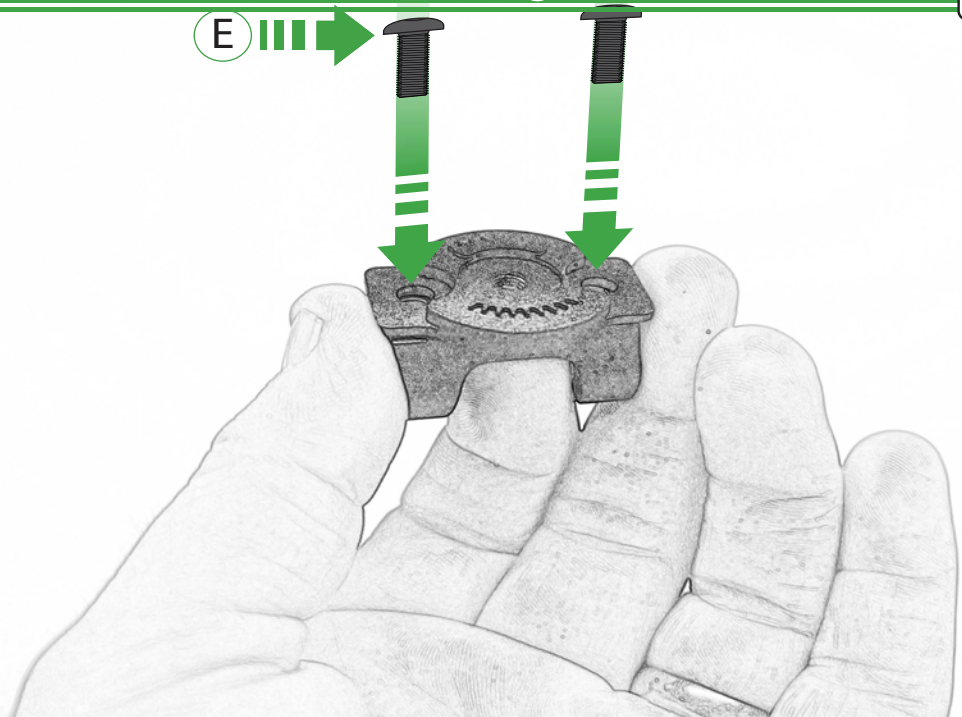

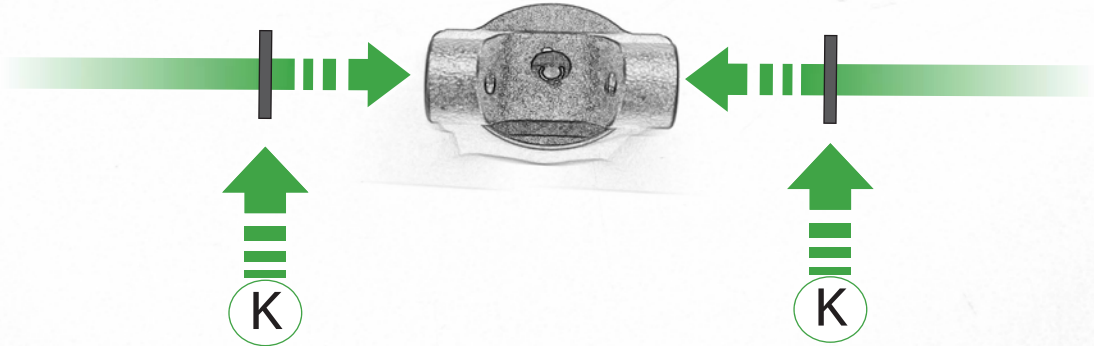

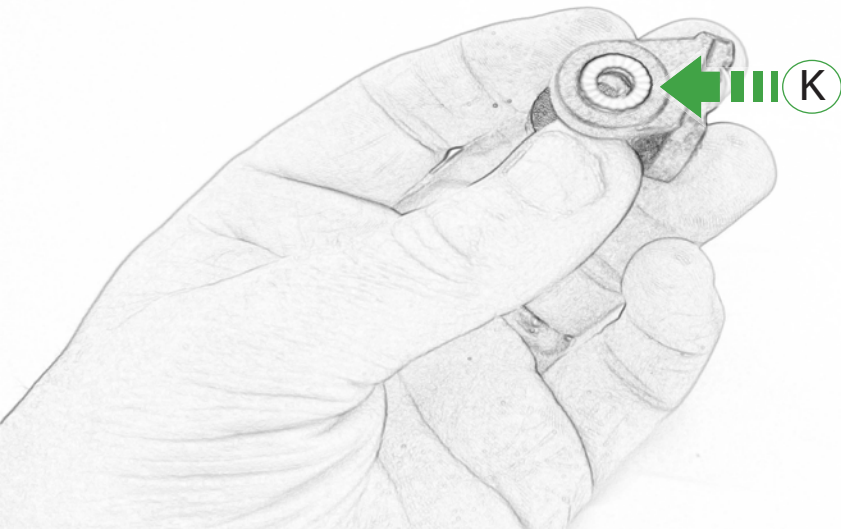

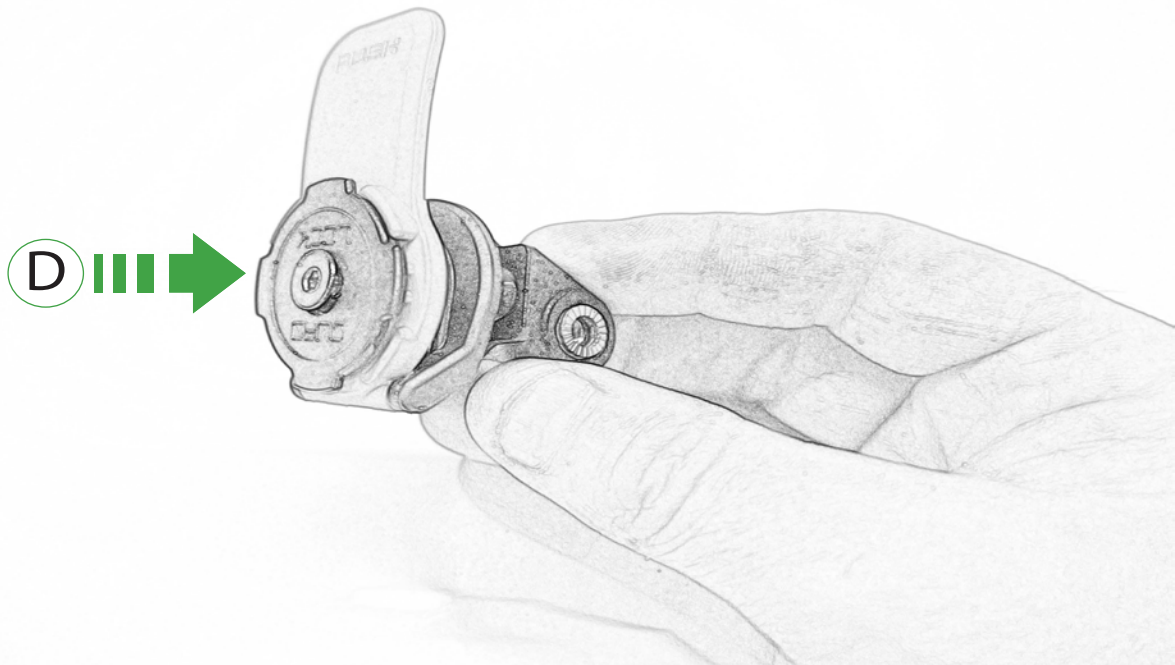

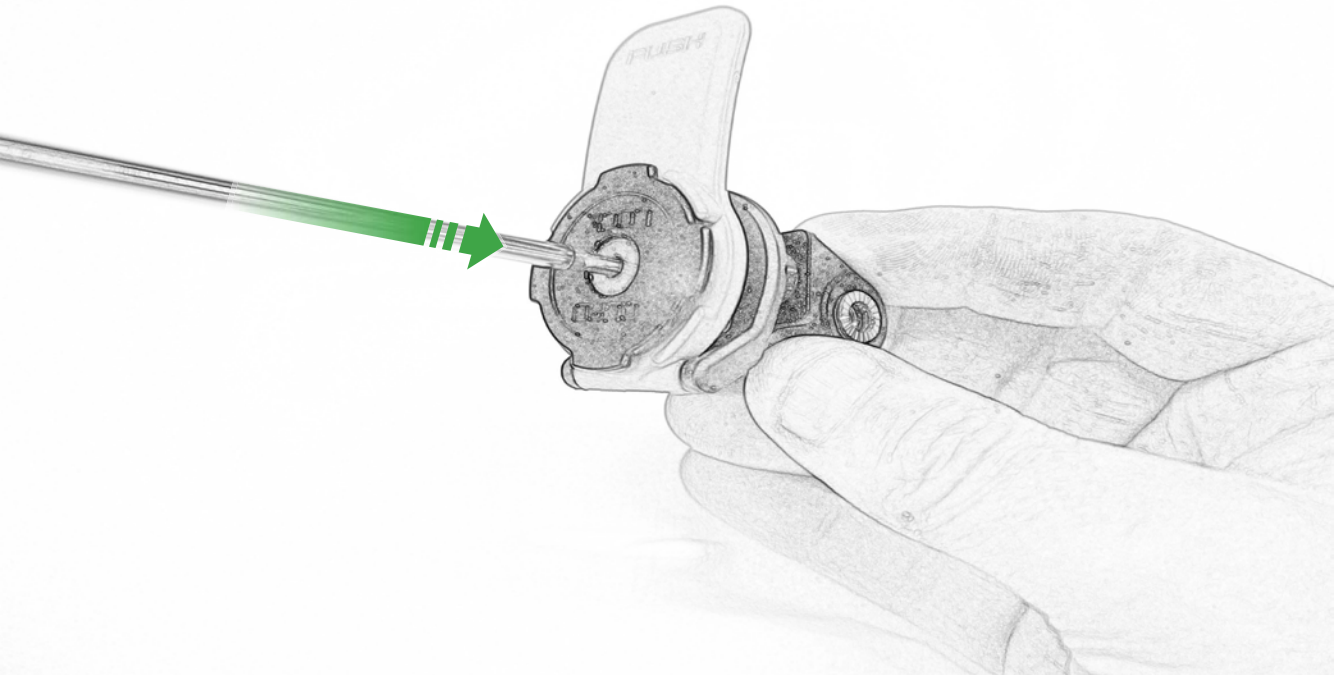

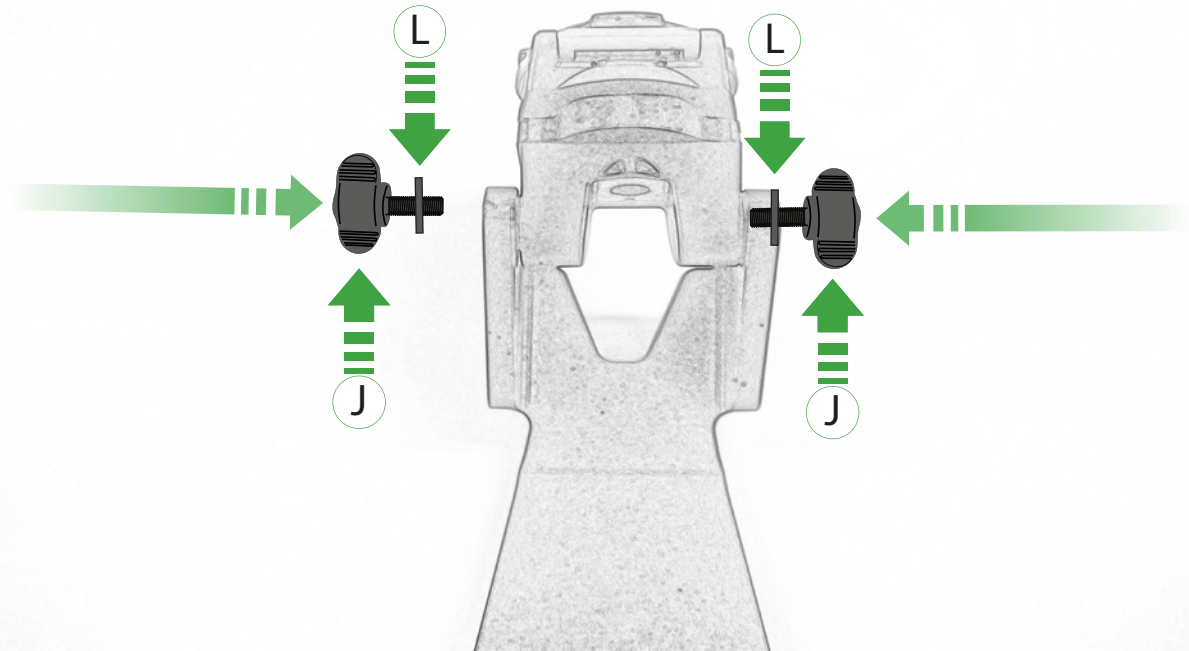



 **ESSENTIAL CHECKS**  [®]

It is recommended that periodic inspections are made to ensure that all bolts are tightened to the specified torque settings.

Should the bike be involved in an accident a thorough inspection should be made and any components that have taken an impact, no matter how small, be replaced

P E R F O R M A N C E [®]



EVOTECH®
P E R F O R M A N C E

www.evotech-performance.com