



**EVOTECH**®  
P E R F O R M A N C E

[www.evotech-performance.com](http://www.evotech-performance.com)

Suzuki GSX-S1000 GT  
Quad Lock Sat Nav Mount



## Kit Contents

- (A) 1 x Main Plate
- (B) 1 x Pivot Plate
- (C) 1 x Quad Lock Sub Bracket
- (D) 1 x Quad Lock Mounting Bracket
- (E) 2 x M5 x 8mm Black Button Head Bolts
- (F) 2 x P-clips (No.1)
- (G) 2 x P-clips (No.2)
- (H) 2 x P-clips (No.3)
- (I) 2 x P-clips (No.4)
- (J) 2 x Lobe Screw
- (K) 2 x Locking Washer
- (L) 2 x M5 Black Washer
- (M) 2 x M4 x 5mm Black Button Head Bolts

## Sub Kit

- (AA) 4 x M5 x 25 Silver Button Head Bolt
- (BB) 4 x Top Hat Spacer

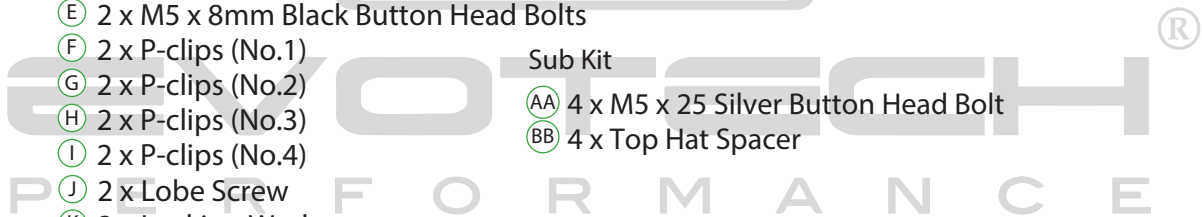

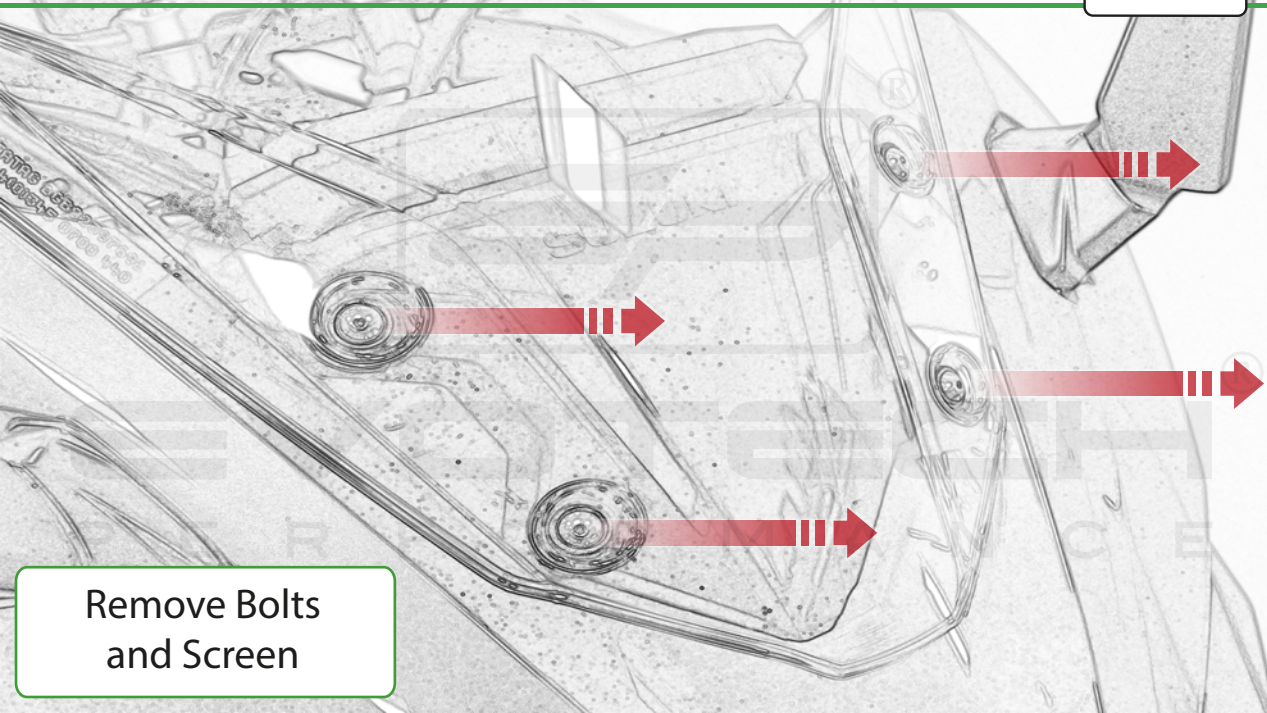

Remove Bolts  
and Screen



Transfer Screen  
Rubber Bungs



EVO RECH<sup>®</sup>  
PERFORMANCE

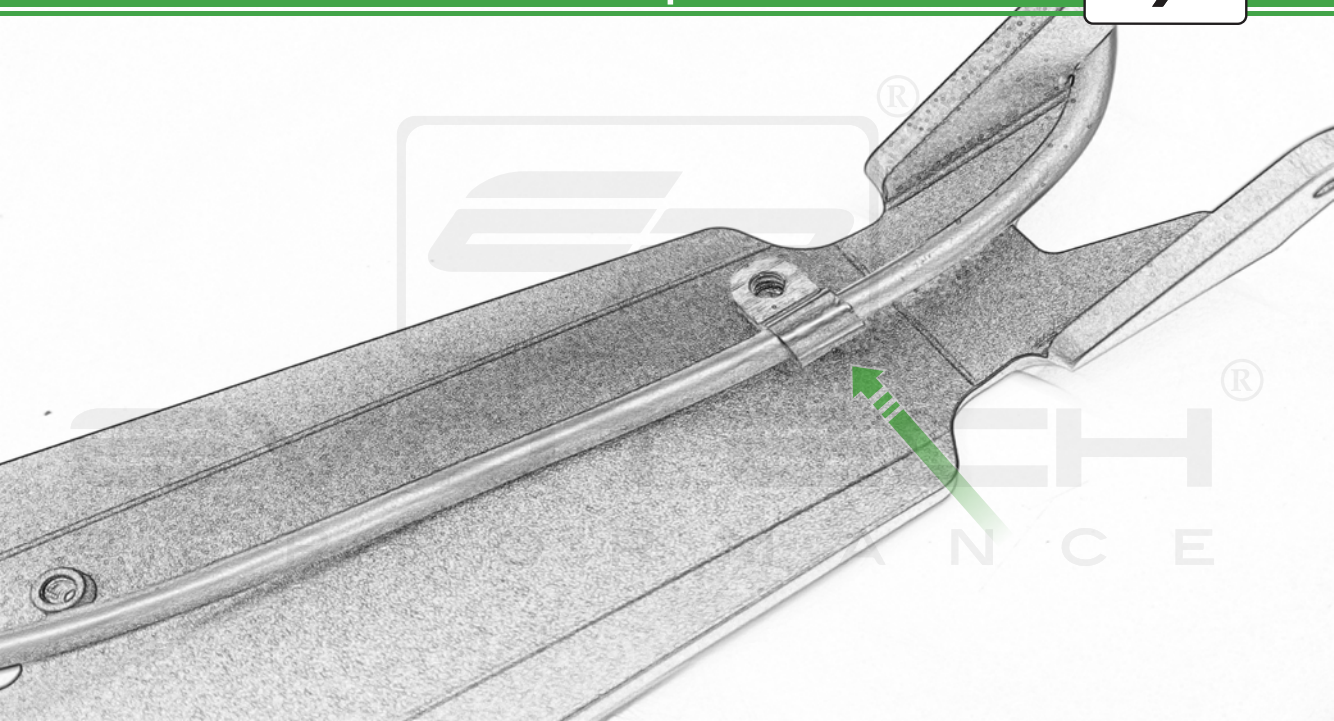

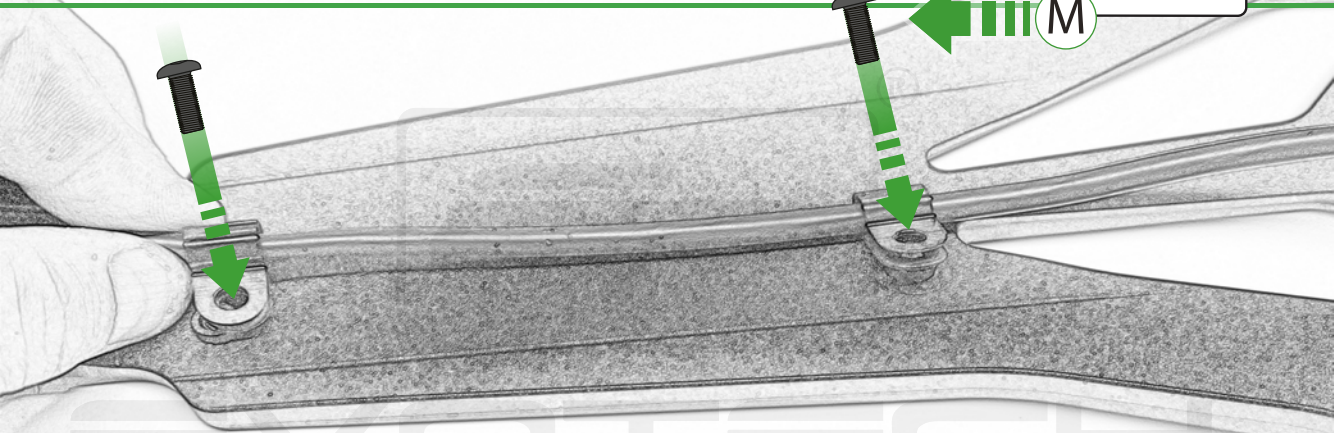

EVO TECH  
P E R F O R M A N C E



EVOTECH  
P E R F O R M A N C E



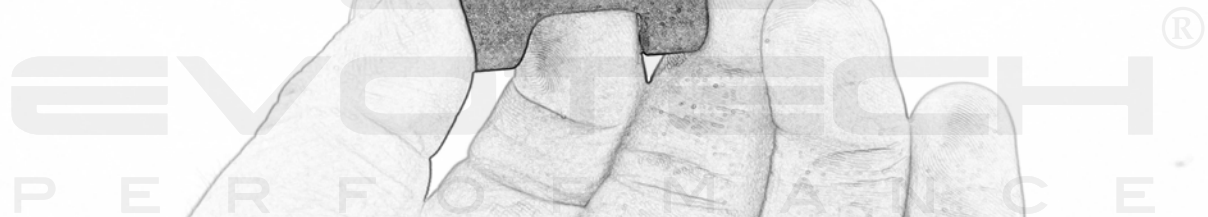
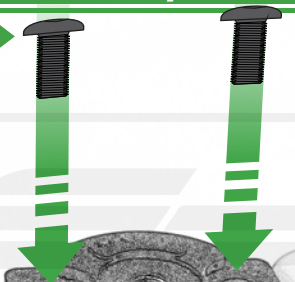

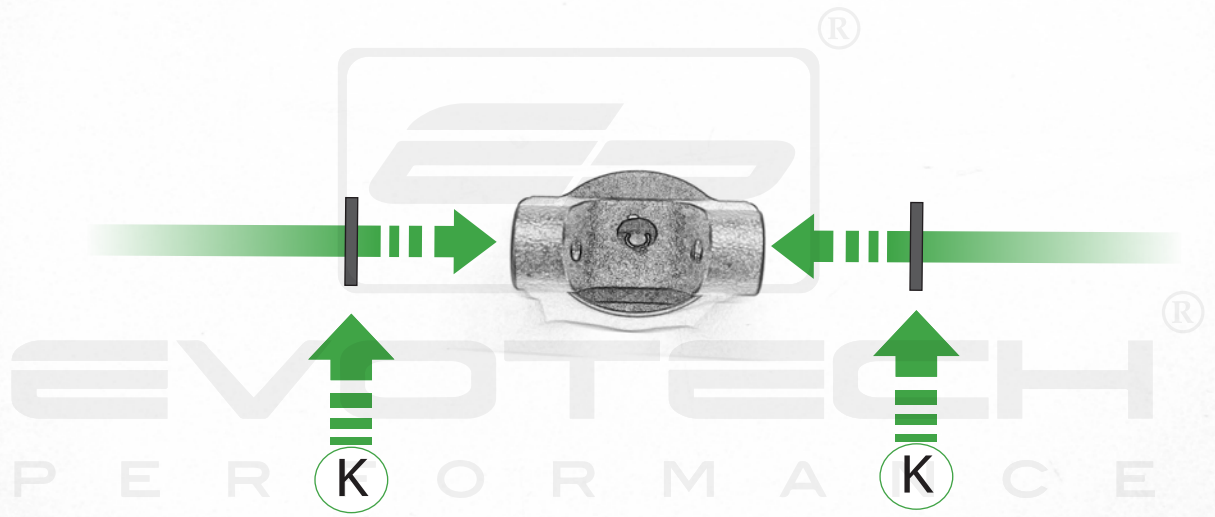



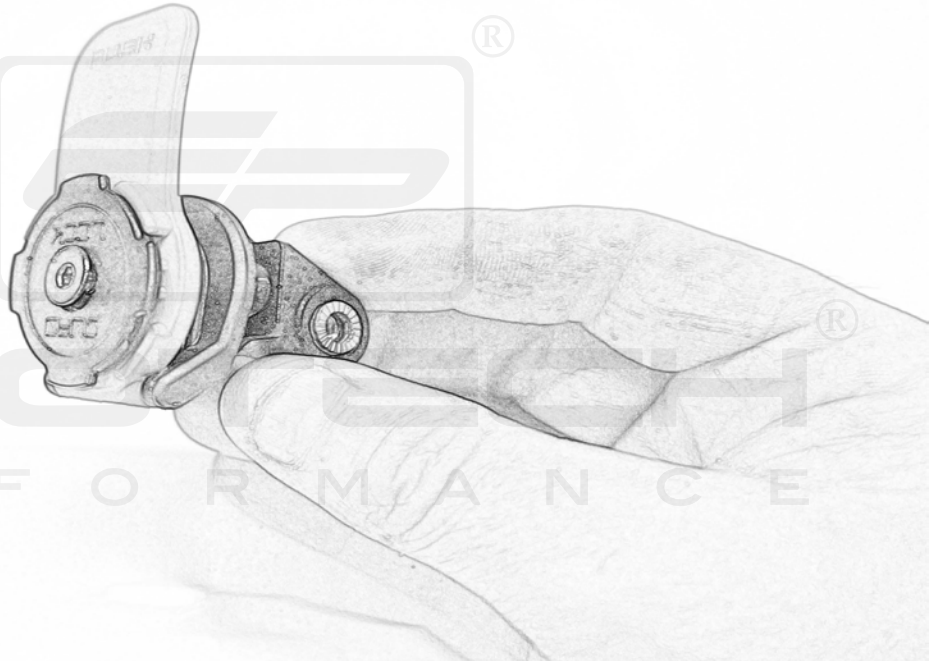

EVERFLOW<sup>®</sup>  
PERFORMANCE<sup>®</sup>

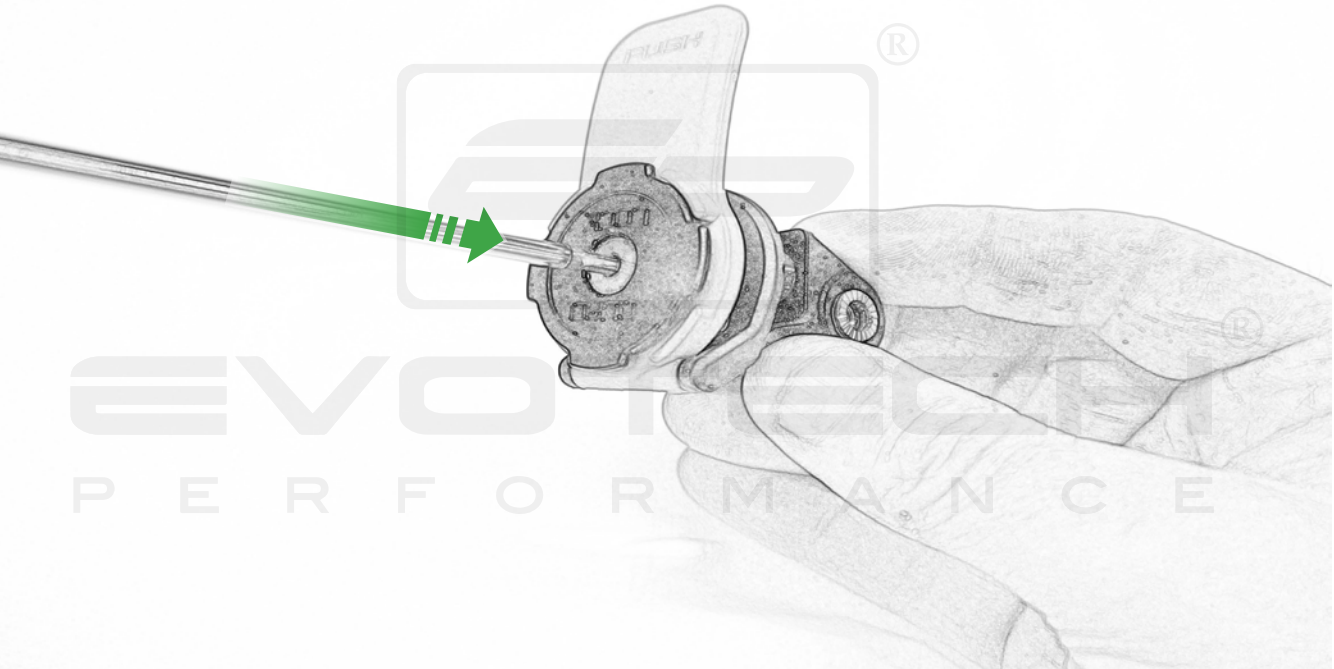

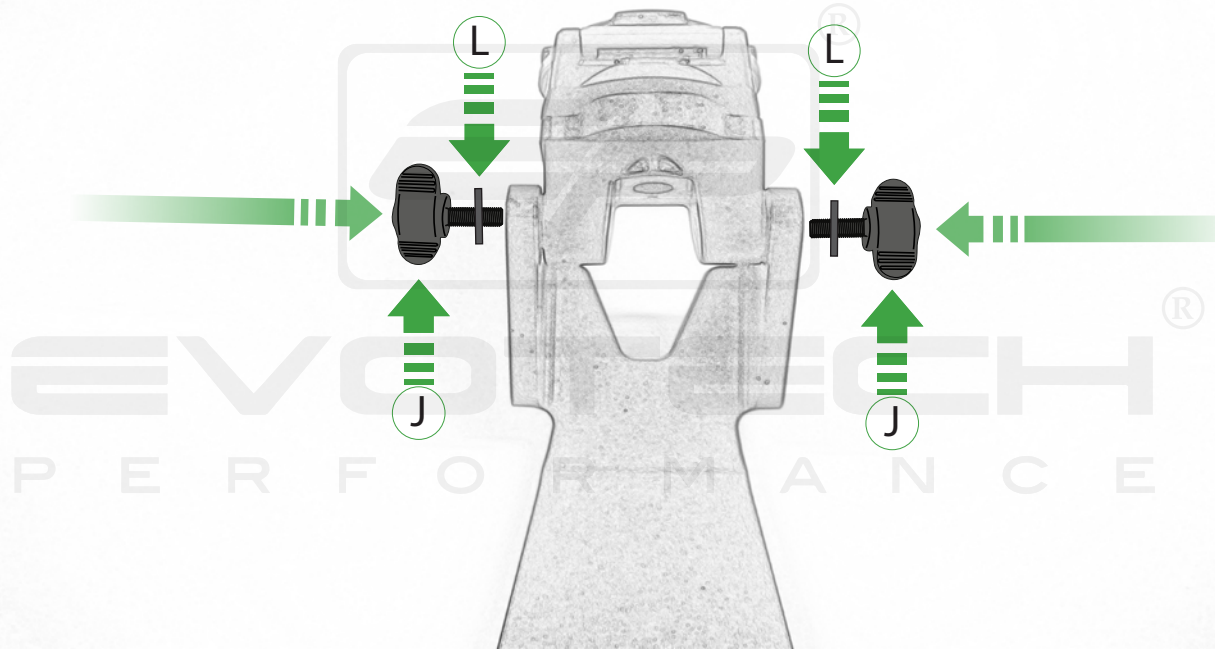

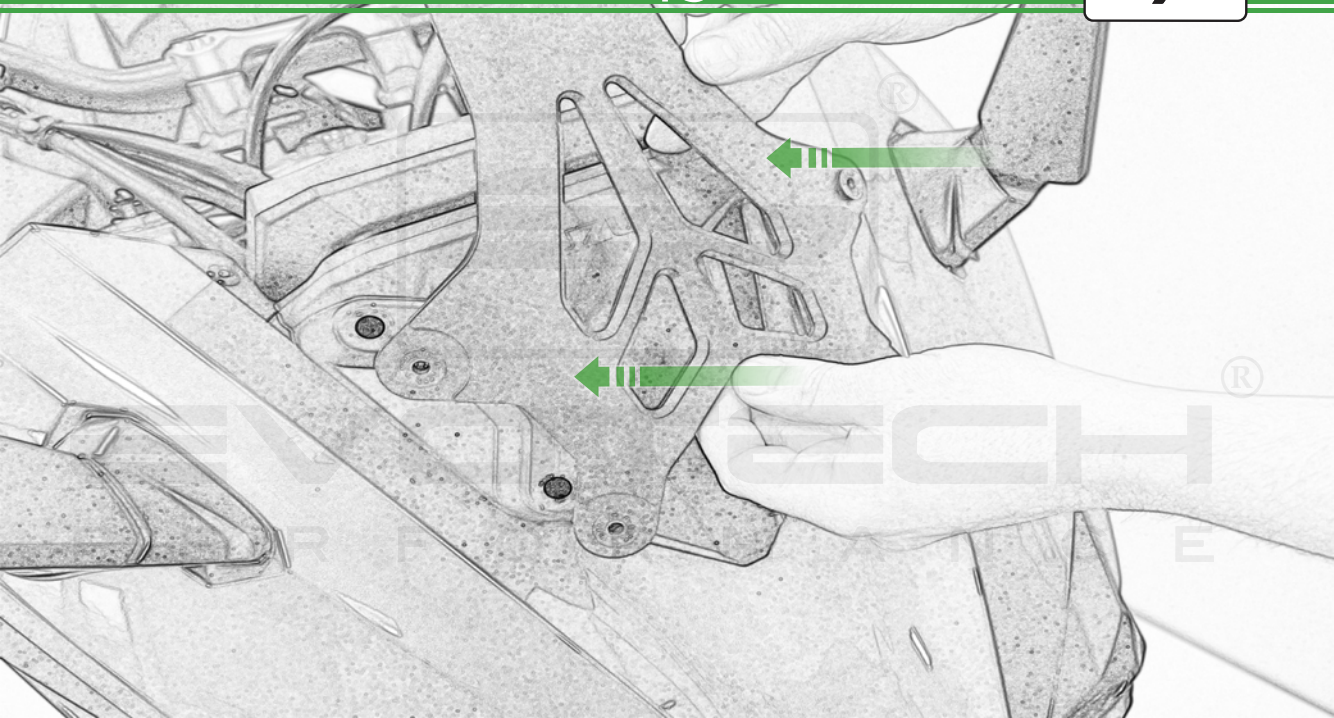

TECH  
E

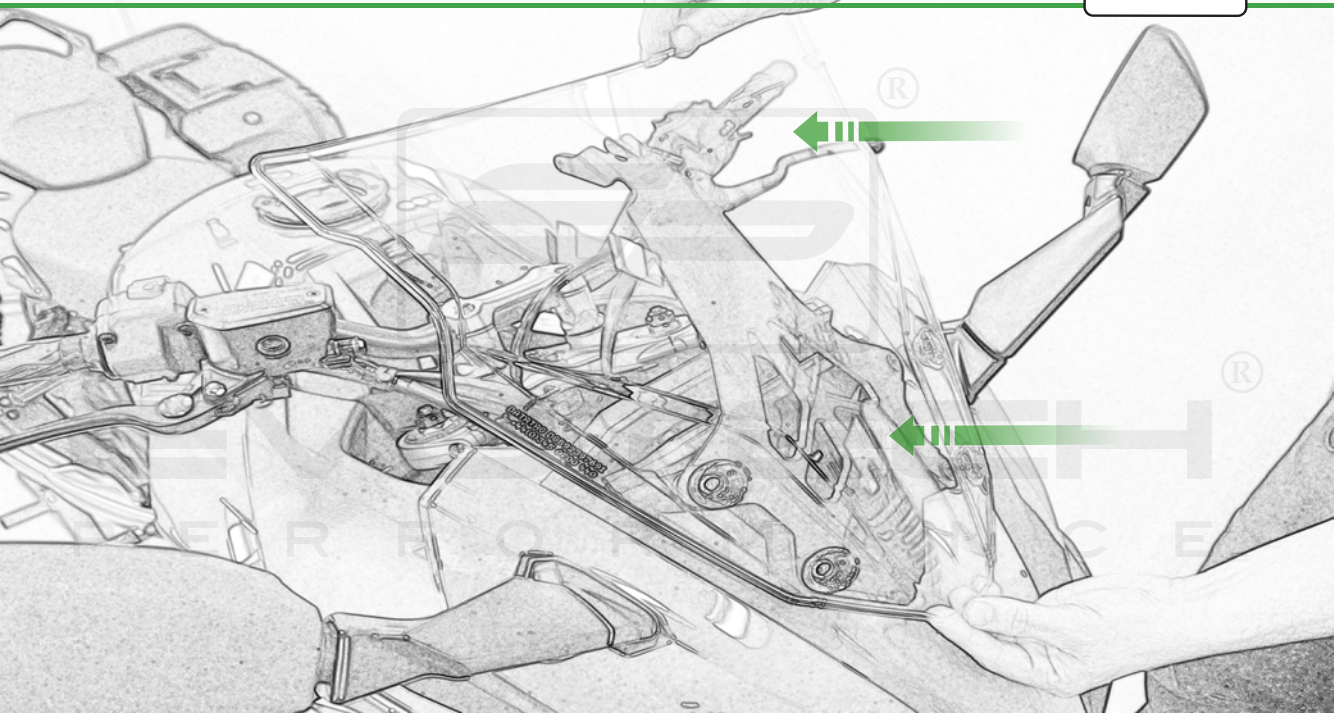



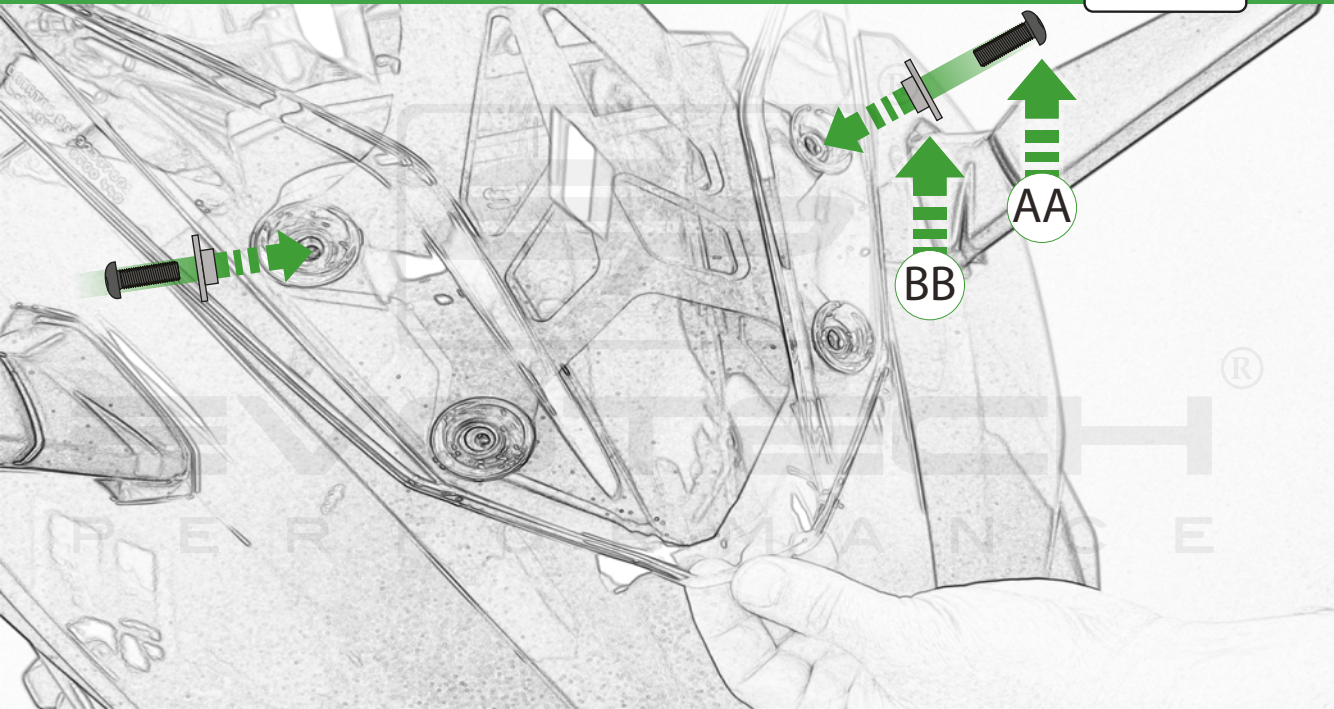

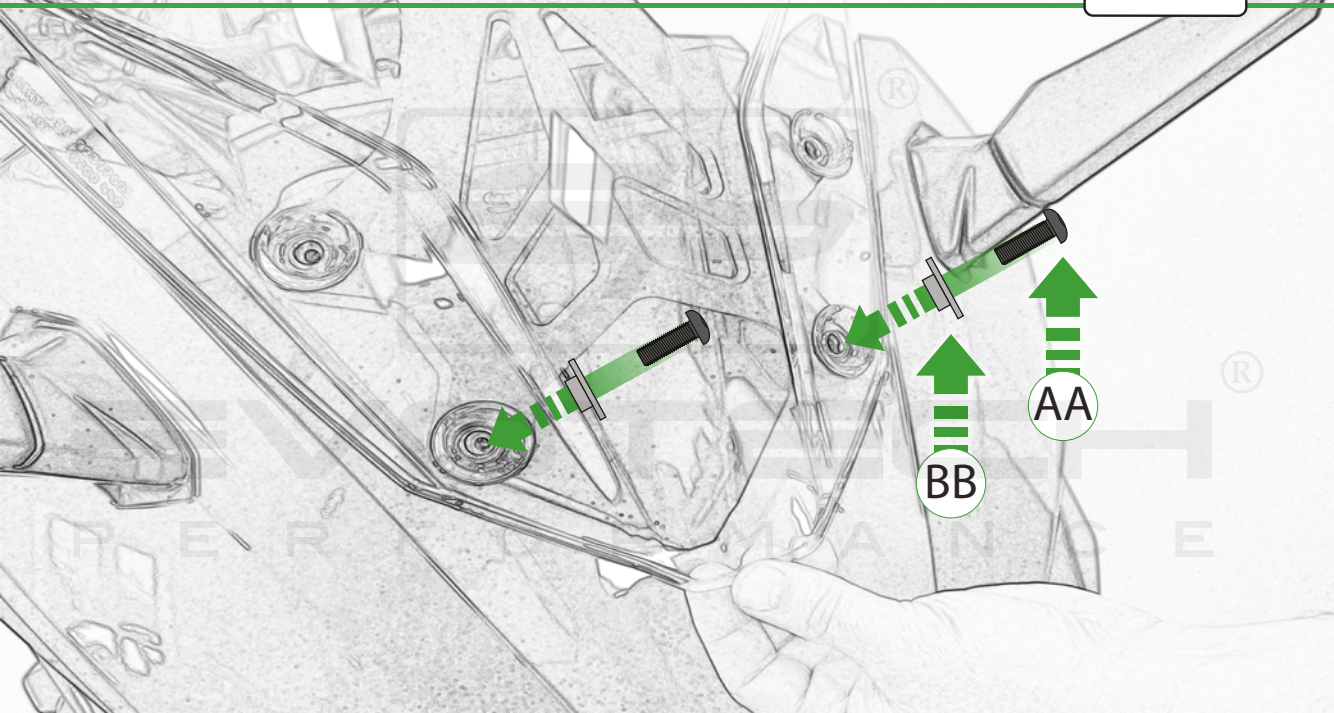



## **ESSENTIAL CHECKS**



It is recommended that periodic inspections are made to ensure that all bolts are tightened to the specified torque settings.

Should the bike be involved in an accident a thorough inspection should be made and any components that have taken an impact, no matter how small, be replaced



**EVOTECH**®  
P E R F O R M A N C E

[www.evotech-performance.com](http://www.evotech-performance.com)