



EVOTECH®
P E R F O R M A N C E

www.evotech-performance.com

Yamaha Tracer 9
Quad Lock Sat Nav Mount



Kit Contents PRN014568-015834

- (A) 1 x Main Plate
- (B) 1 x Pivot Plate
- (C) 1 x Quad Lock Sub Bracket
- (D) 1 x Quad Lock Mounting Bracket
- (E) 2 x M5 x 8mm Black Button Head Bolts
- (F) 2 x P-clips (No.1)
- (G) 2 x P-clips (No.2)
- (H) 2 x P-clips (No.3)
- (I) 2 x P-clips (No.4)
- (J) 2 x Lobe Screw
- (K) 2 x Locking Washer
- (L) 2 x M5 Black Washer
- (M) 2 x M4 x 5mm Black Button Head Bolts
- Sub Kit
- (N) 1 x M5 x 12 Caphead
- (O) 1 x T-Clamp Bracket
- (P) 3 x M5 x 20 Flange Bolt

PERFORMANCE

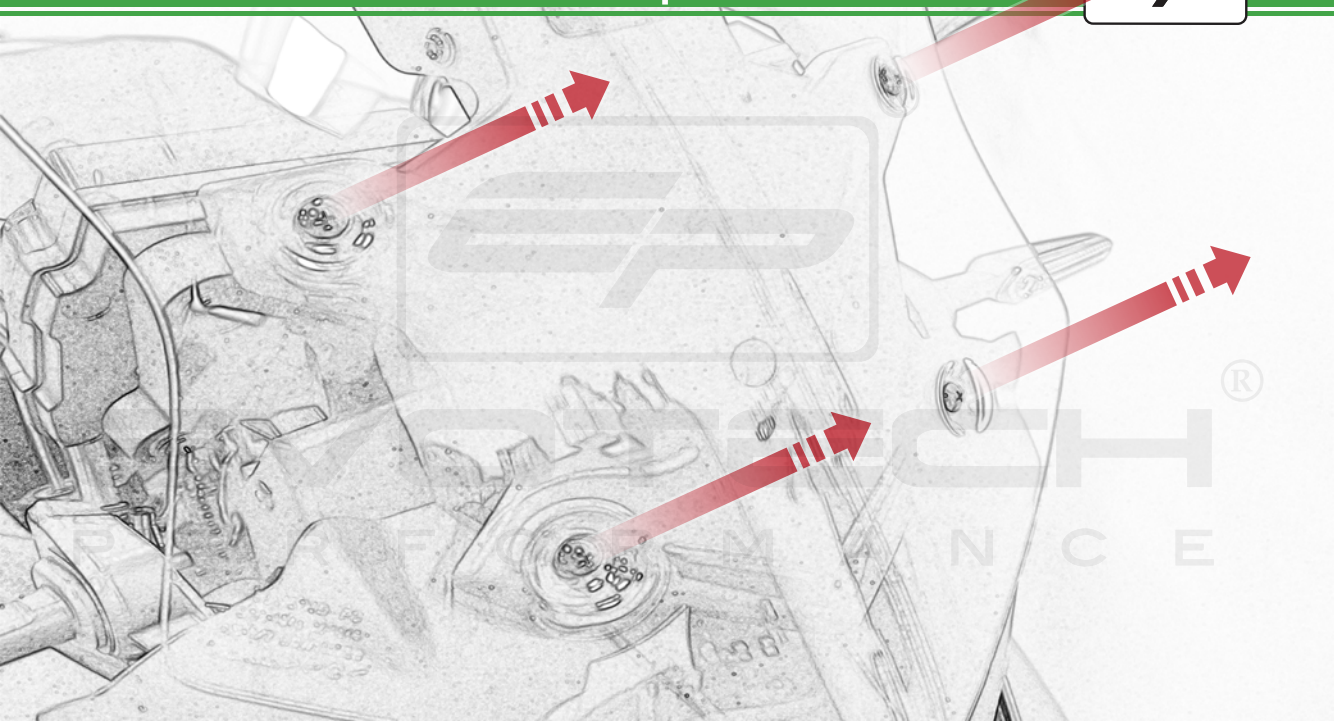

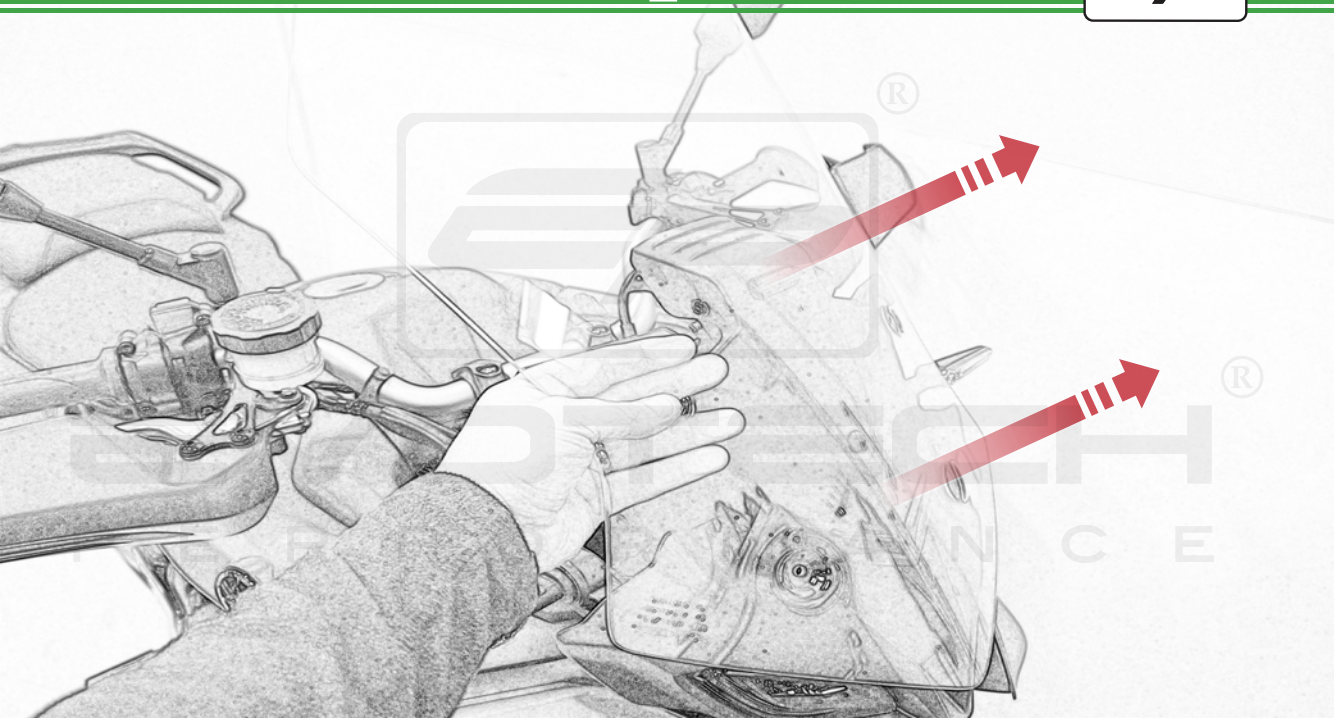

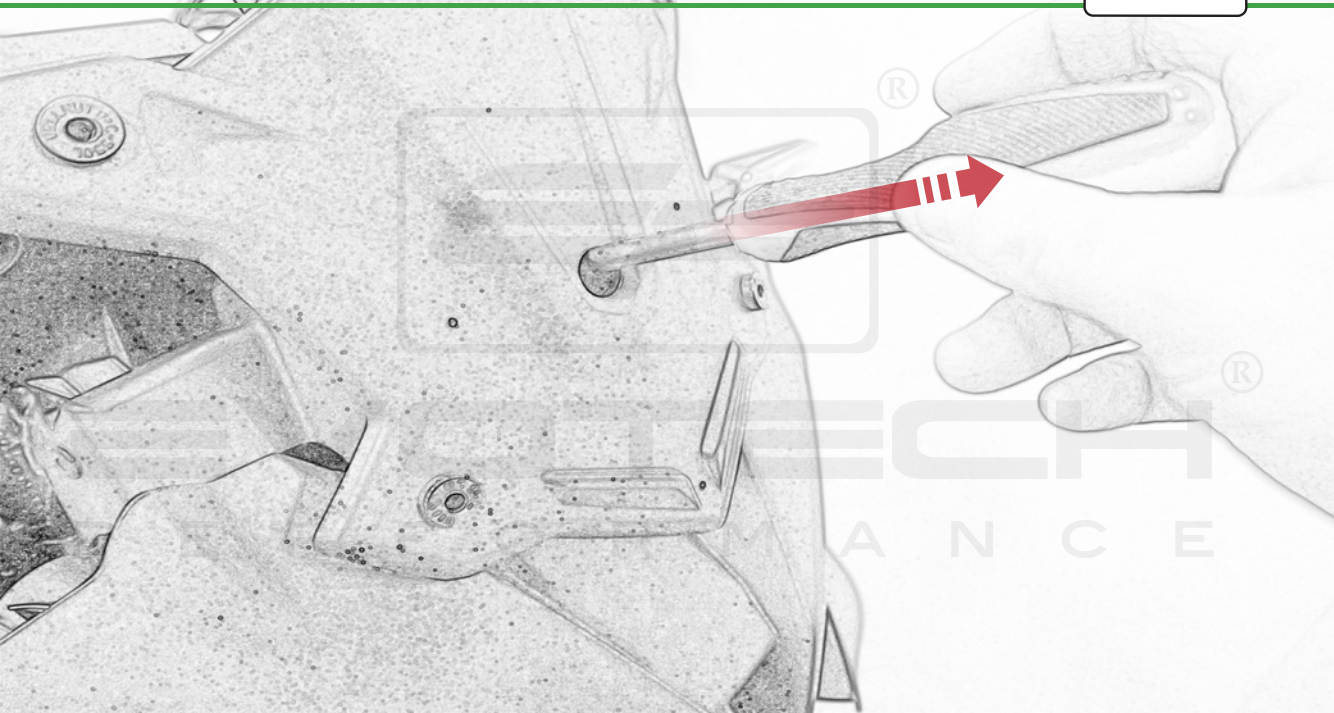

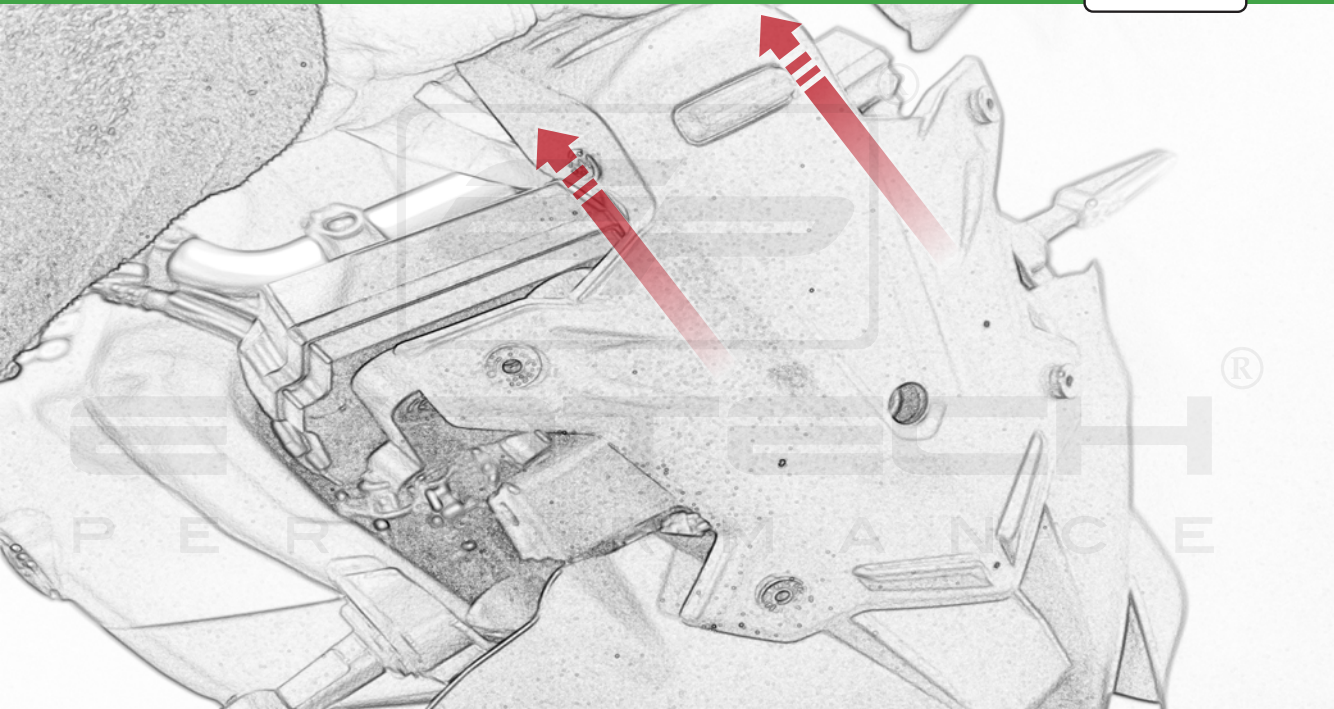

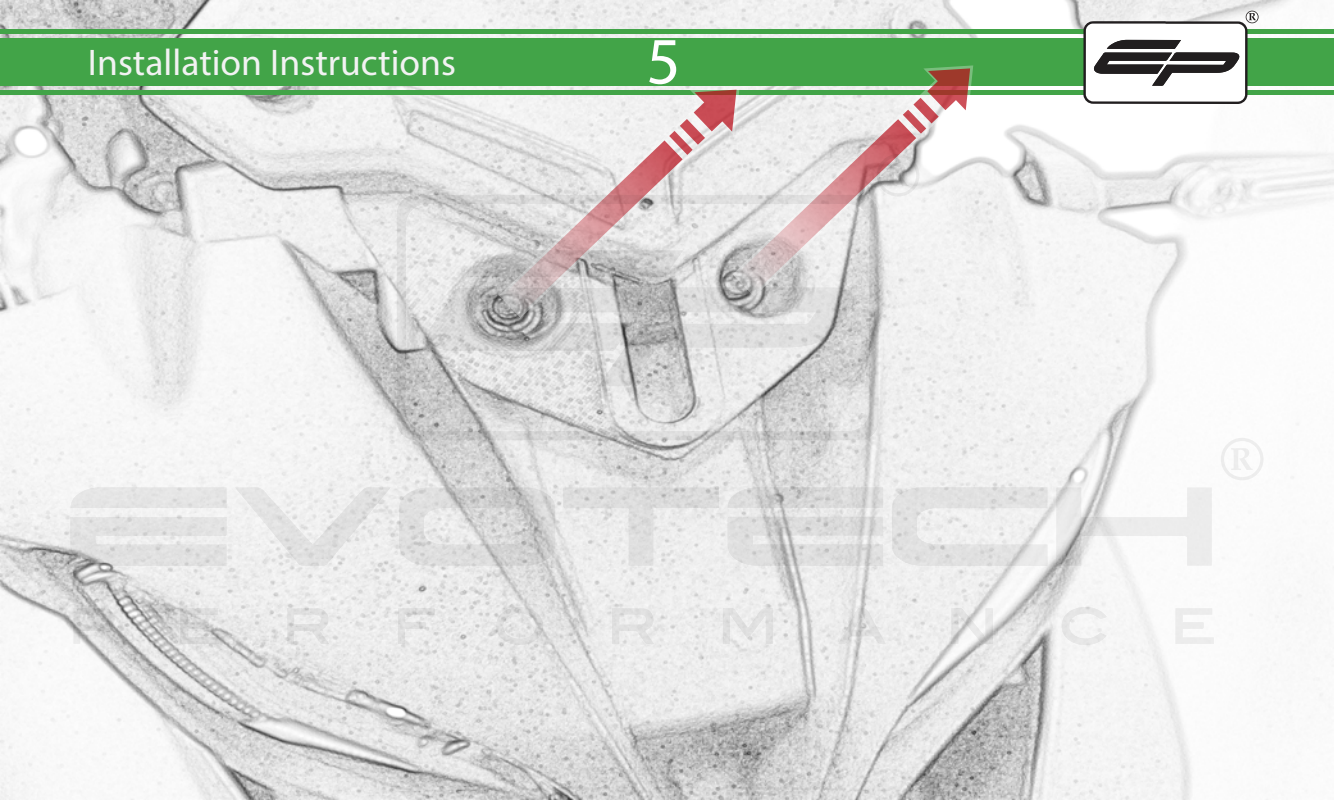

EVOTECH[®]
PERFORMANCE

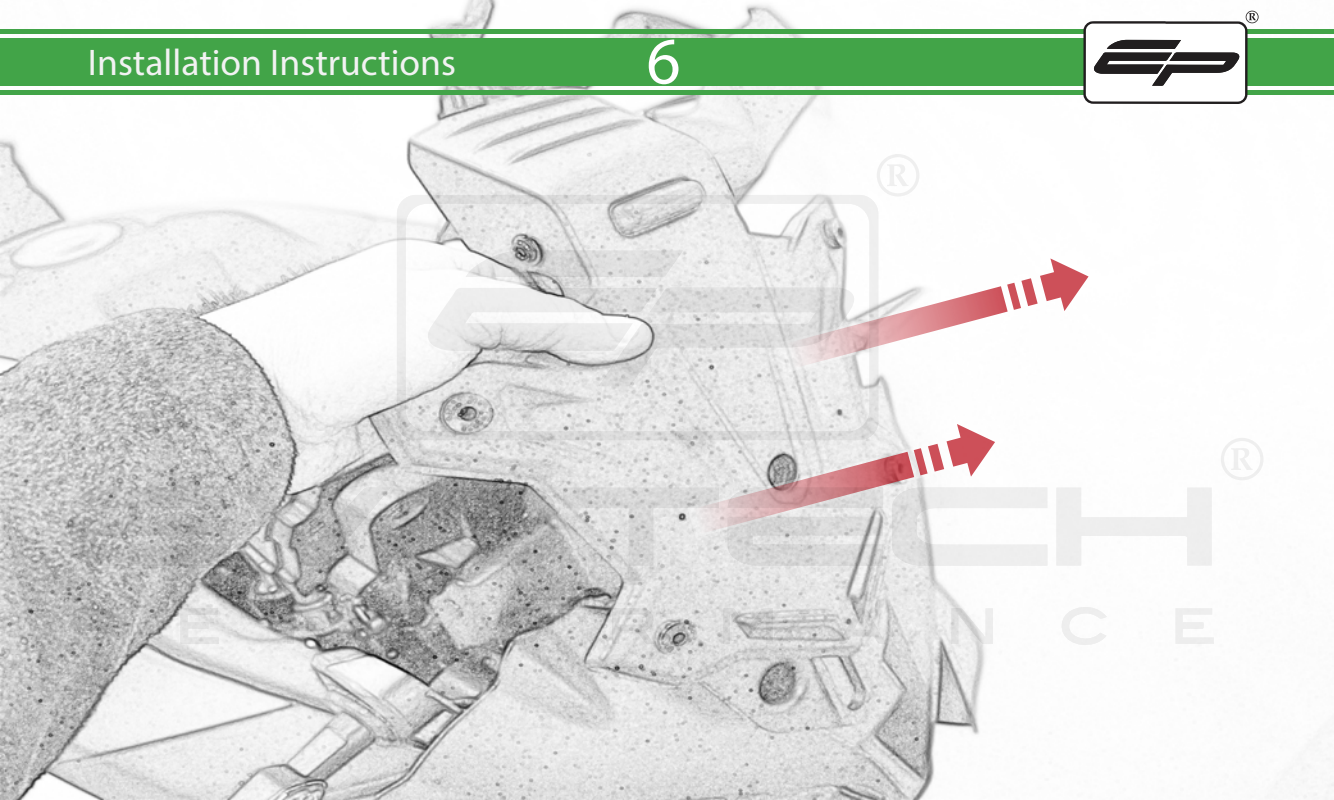



EVOTECH
P E R F O R M A N C E



E 

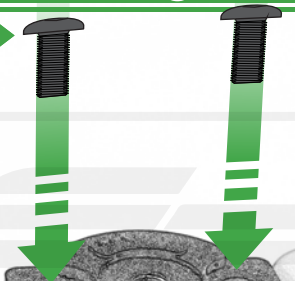

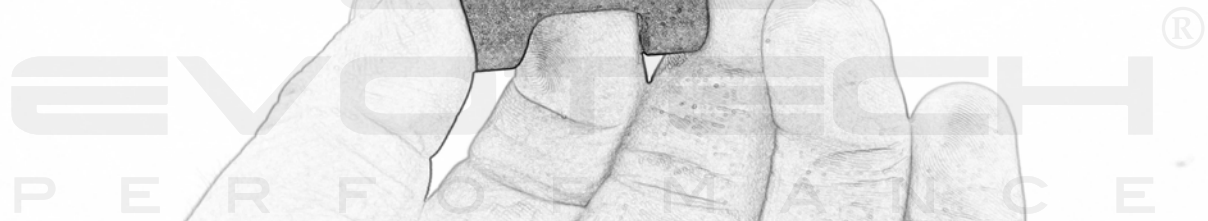
A large, semi-transparent watermark of the EVO-TECH PERFORMANCE logo is centered on the page. The logo features the word 'EVO-TECH' in a large, bold, sans-serif font, with 'PERFORMANCE' written in a smaller font below it. The letters are spaced out across the width of the page.

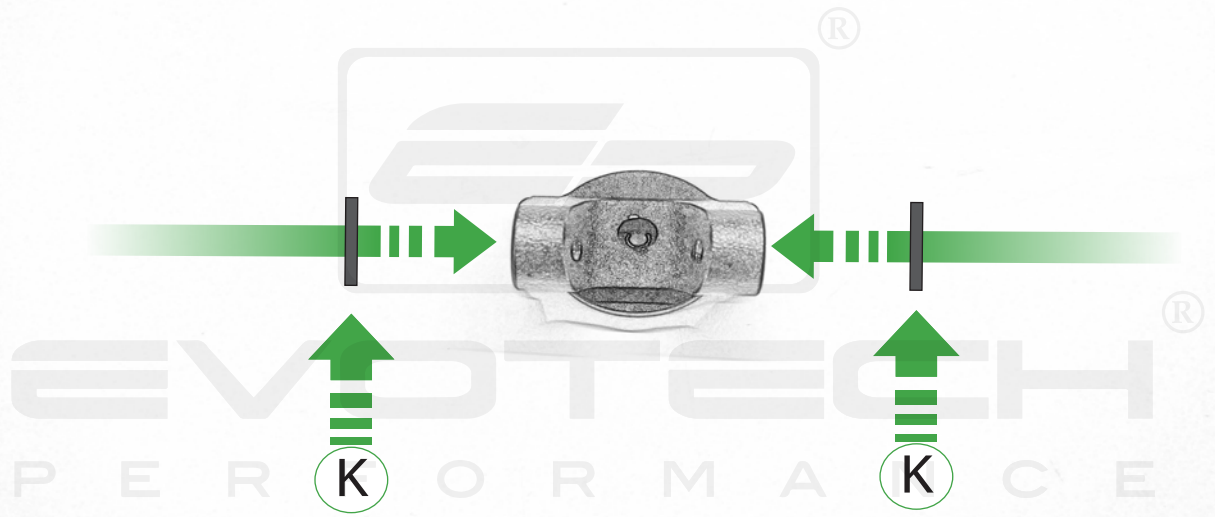



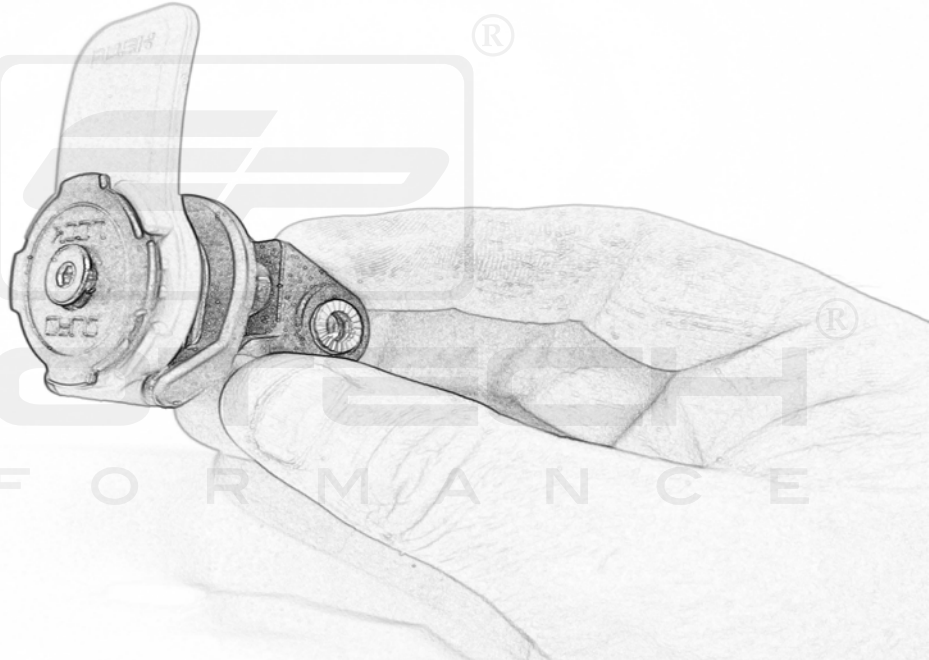

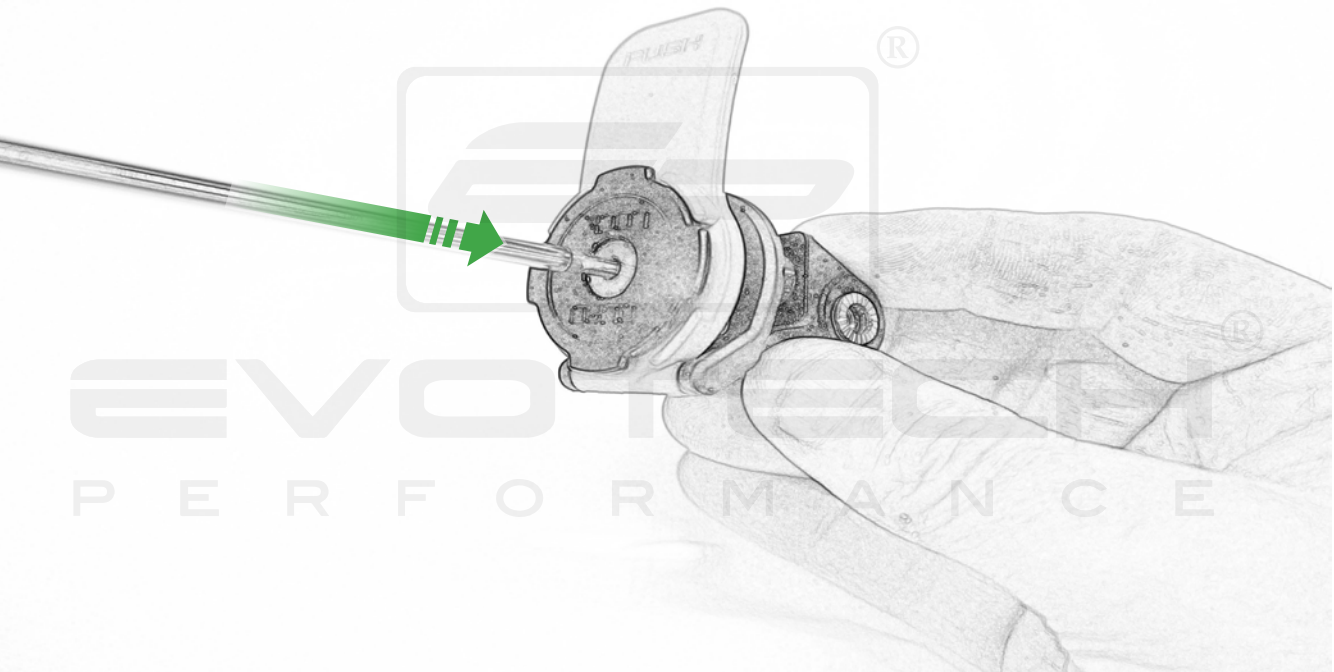

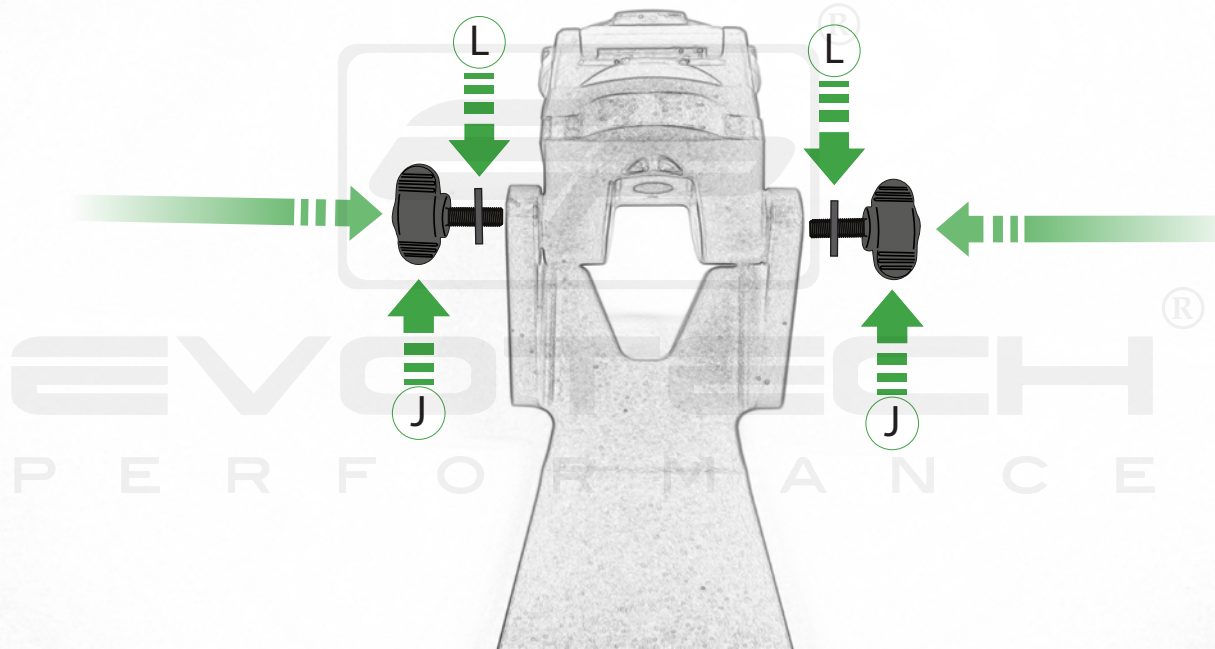

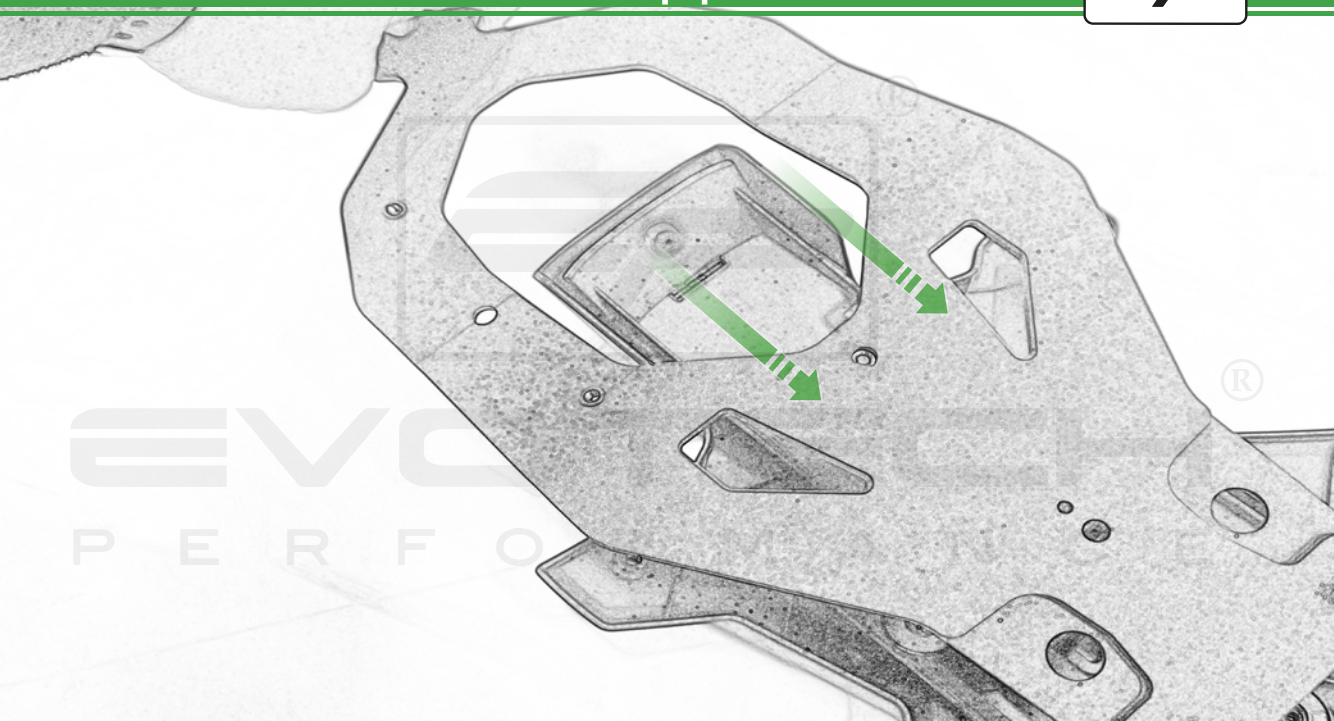

EVO
PERFO



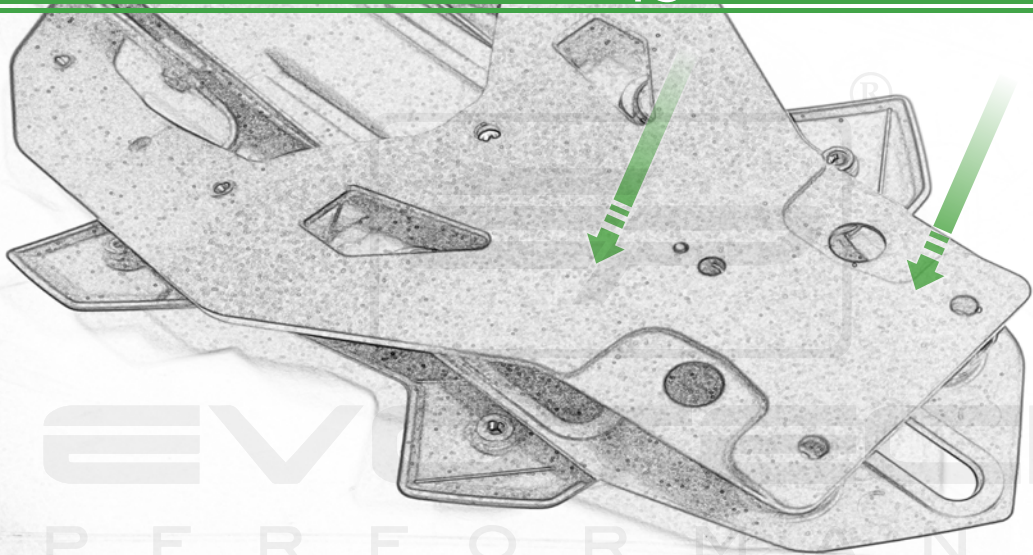

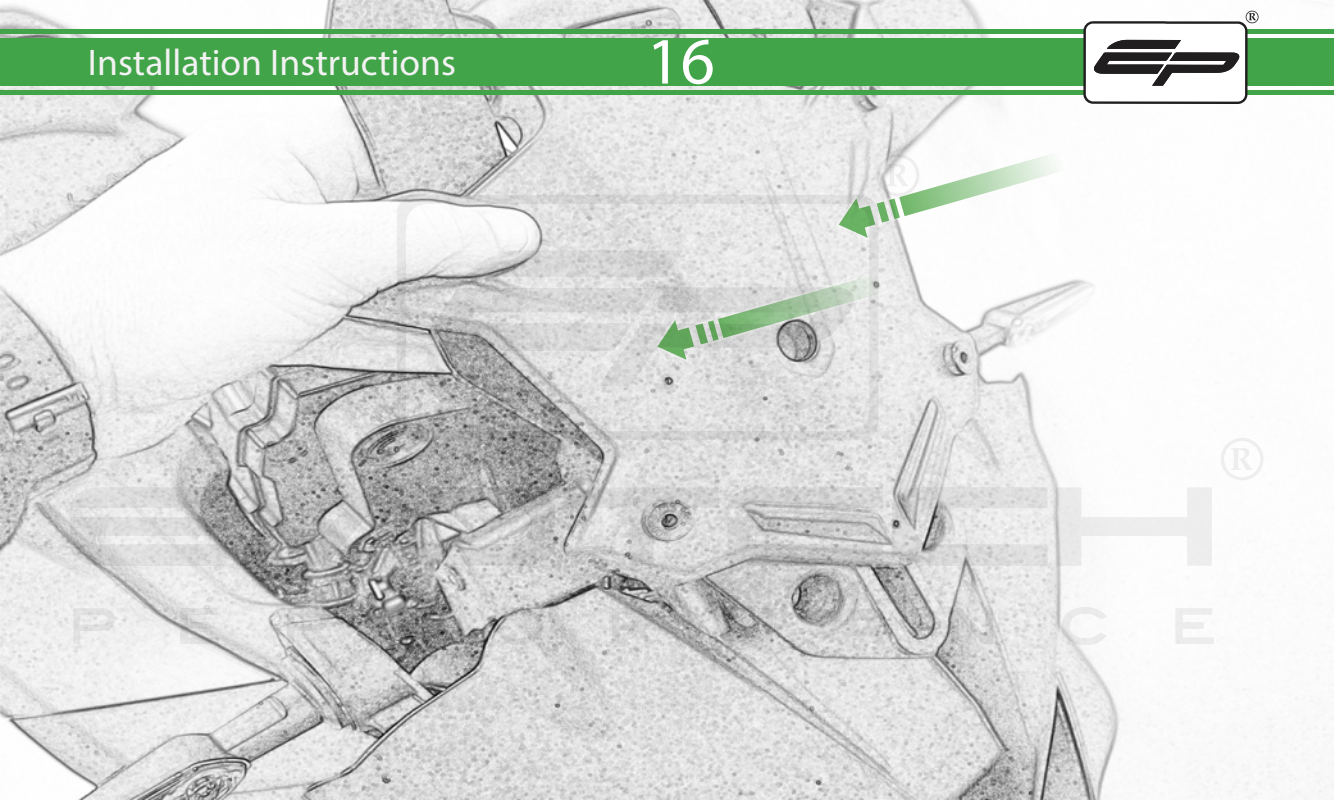

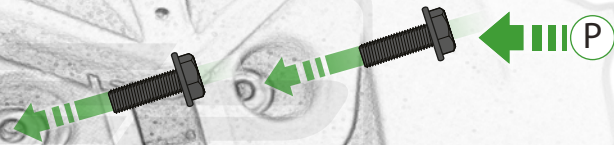
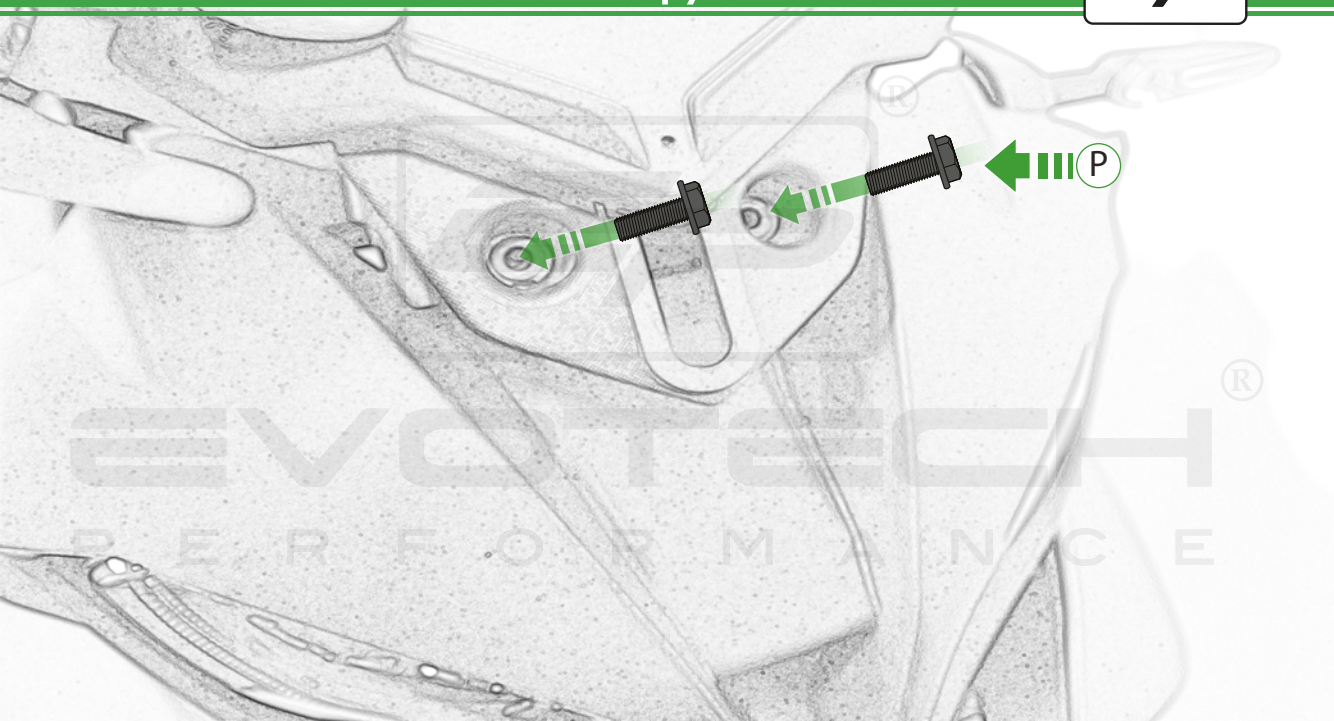

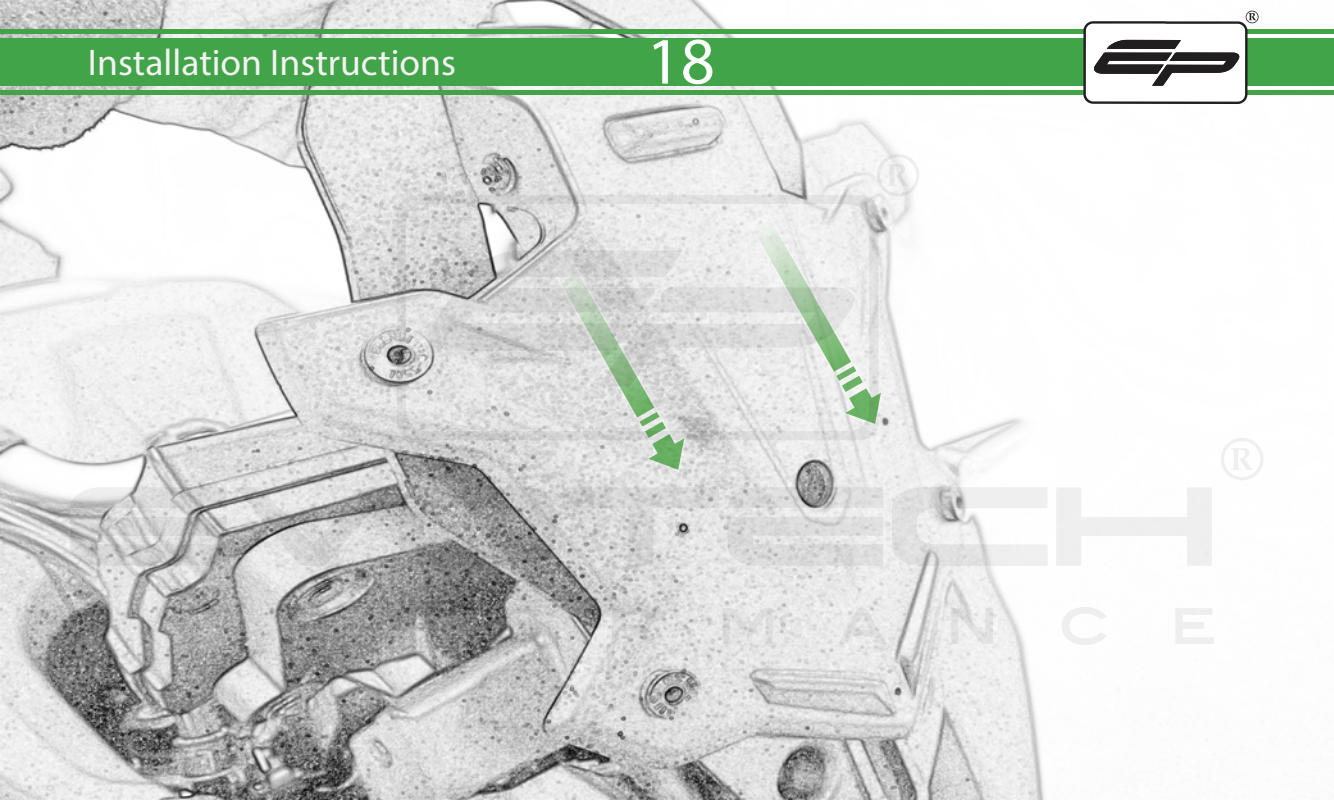

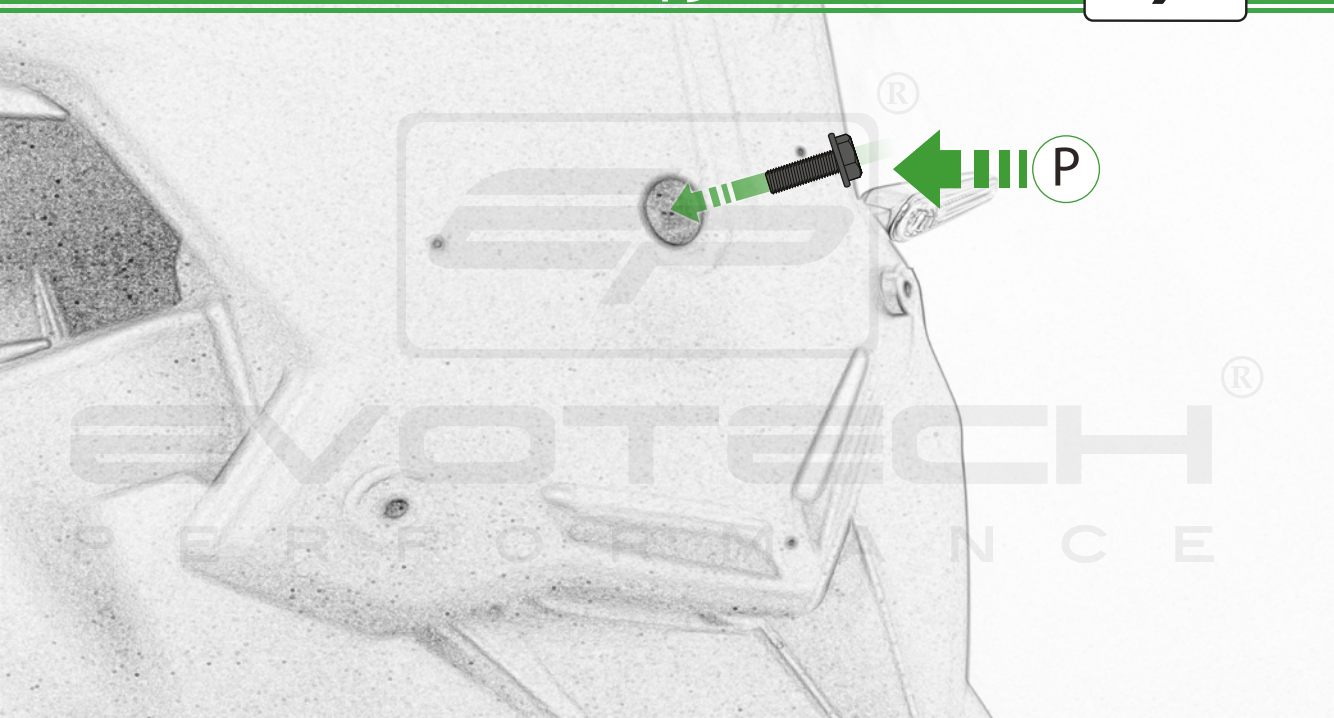

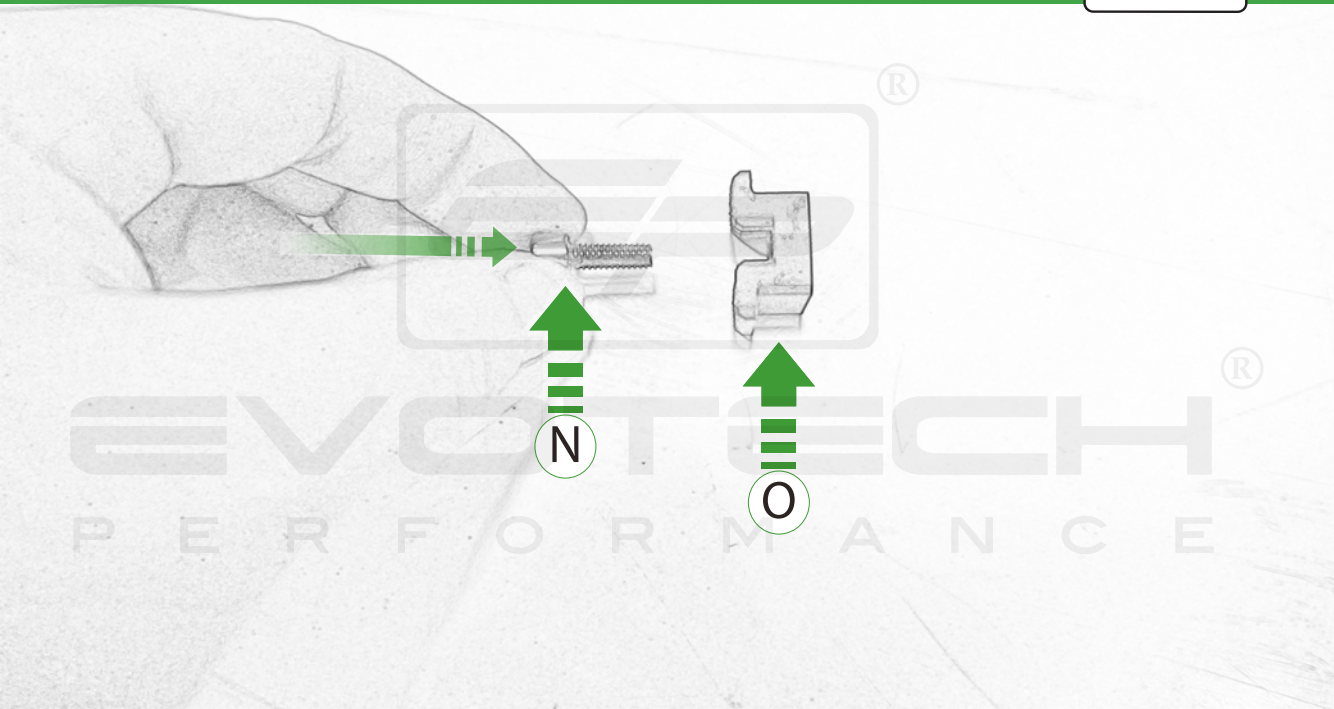

N

O

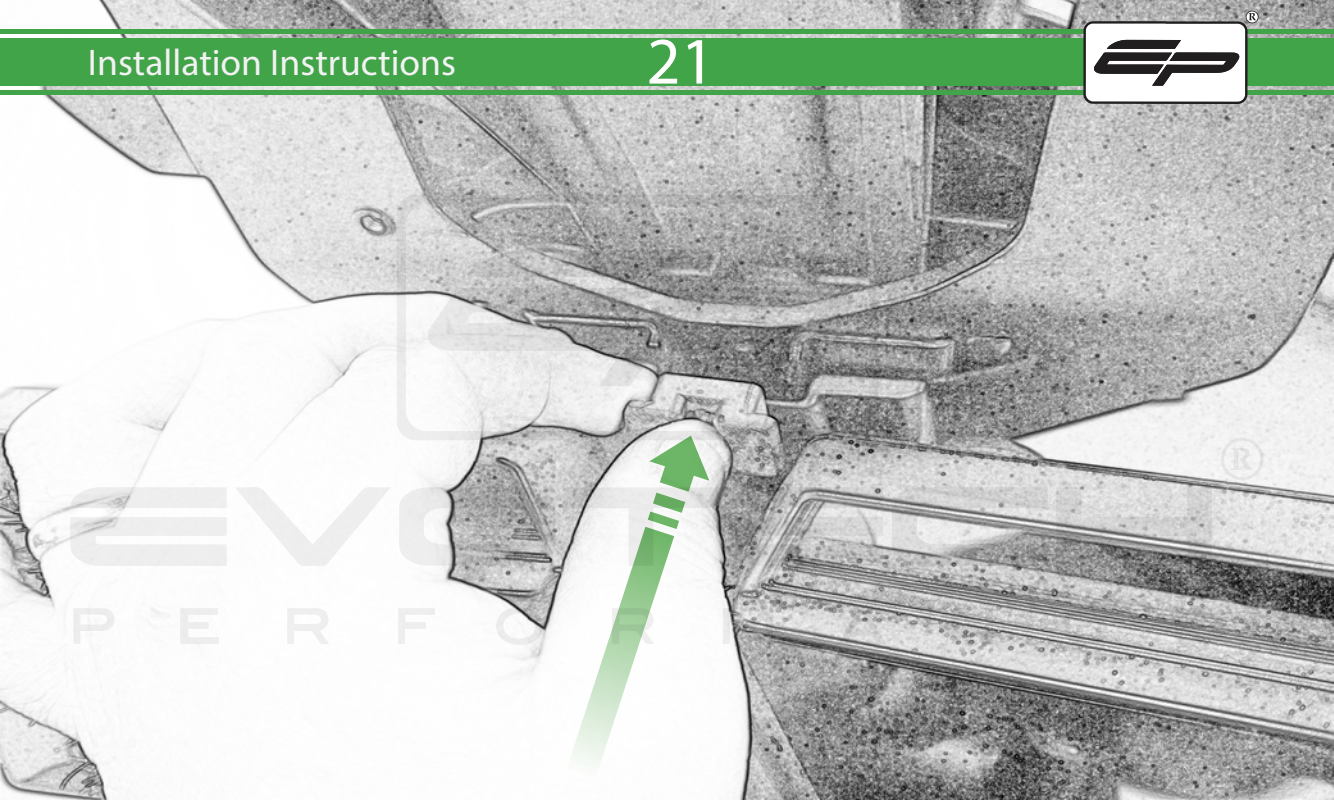

EVOLVING
PERFORMANCE

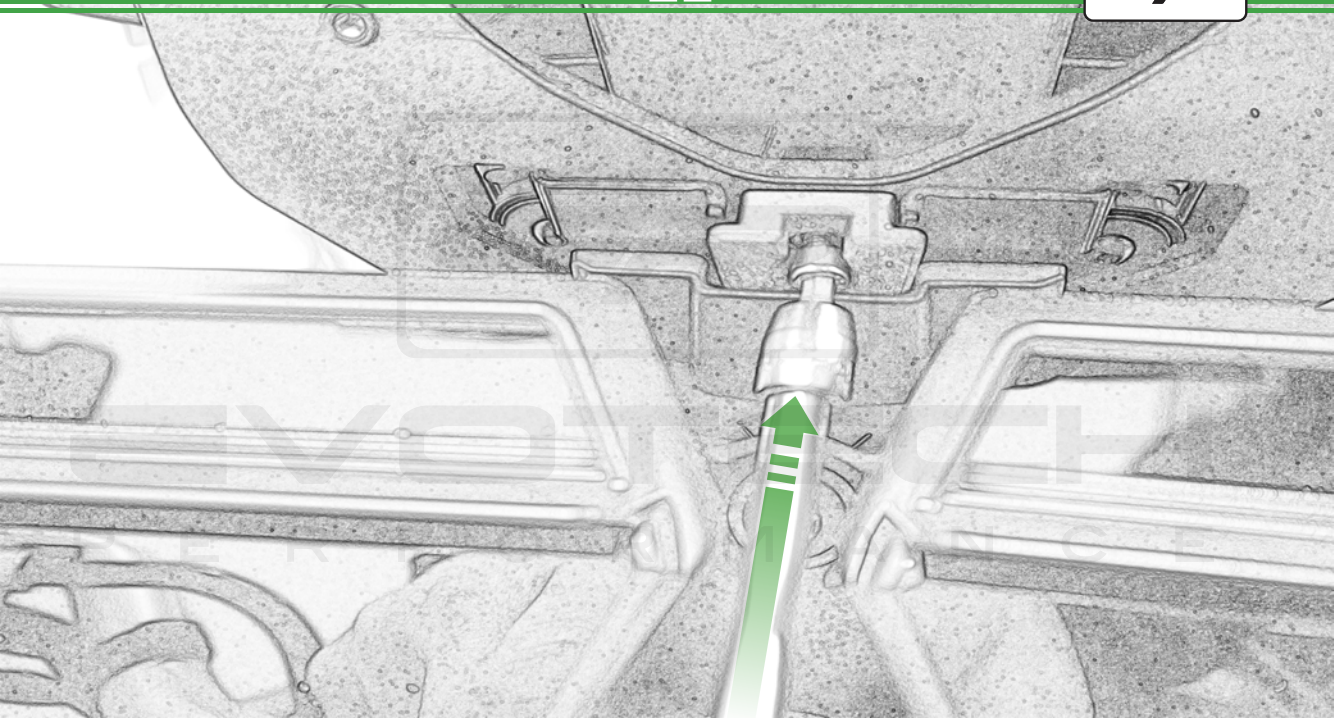

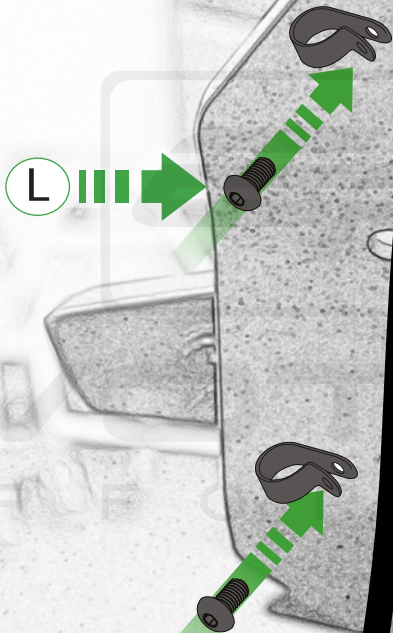



ESSENTIAL CHECKS

It is recommended that periodic inspections are made to ensure that all bolts are tightened to the specified torque settings.

Should the bike be involved in an accident a thorough inspection should be made and any components that have taken an impact, no matter how small, be replaced

EVOTECH 
P E R F O R M A N C E



EVOTECH®
P E R F O R M A N C E

www.evotech-performance.com