



EVOTECH®
P E R F O R M A N C E

www.evotech-performance.com

Yamaha Tracer 7 Quad lock Sat Nav
Installation Instructions



Kit Contents PRN014568-015832

- (A) 1 x Main Plate
 - (B) 1 x Pivot Plate
 - (C) 1 x Quad Lock Sub Bracket
 - (D) 1 x Quad Lock Mounting Bracket
 - (E) 2 x M5 x 8mm Black Button Head Bolts
 - (F) 2 x P-clips (No.1)
 - (G) 2 x P-clips (No.2)
 - (H) 2 x P-clips (No.3)
 - (I) 2 x P-clips (No.4)
 - (J) 2 x Lobe Screw
 - (K) 2 x Locking Washer
 - (L) 2 x M5 Black Washer
 - (M) 2 x M4 x 5mm Black Button Head Bolts
- Sub Kit
- (N) 4 x Plastic Washers
 - (O) 4 x M5 x 25mm Black Button Bolt

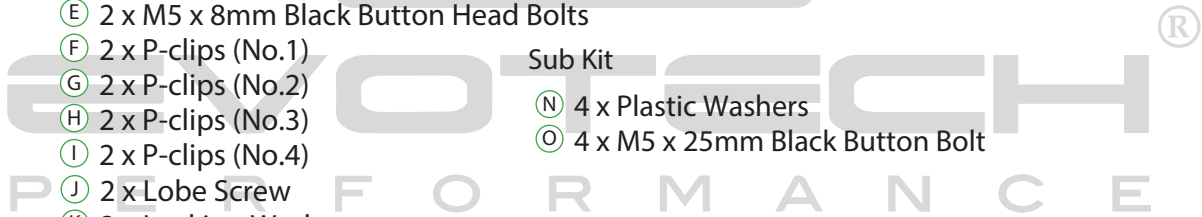



EVOTECH
P E R F O R M A N C E

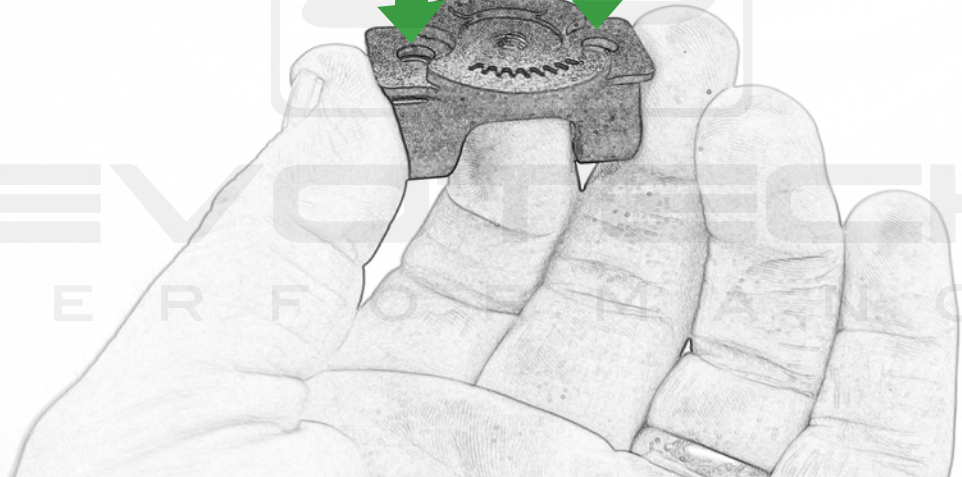
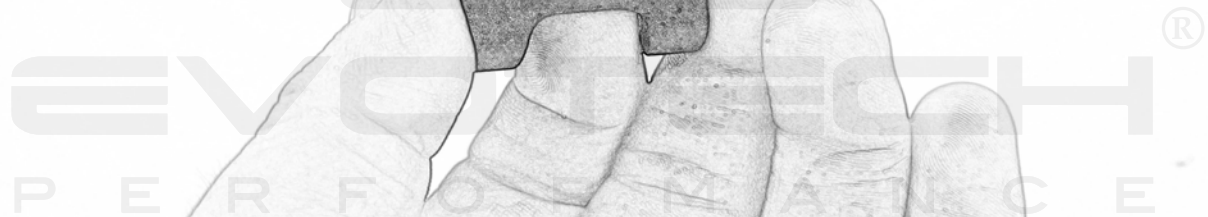
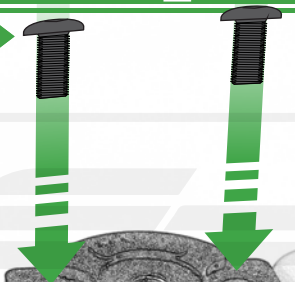

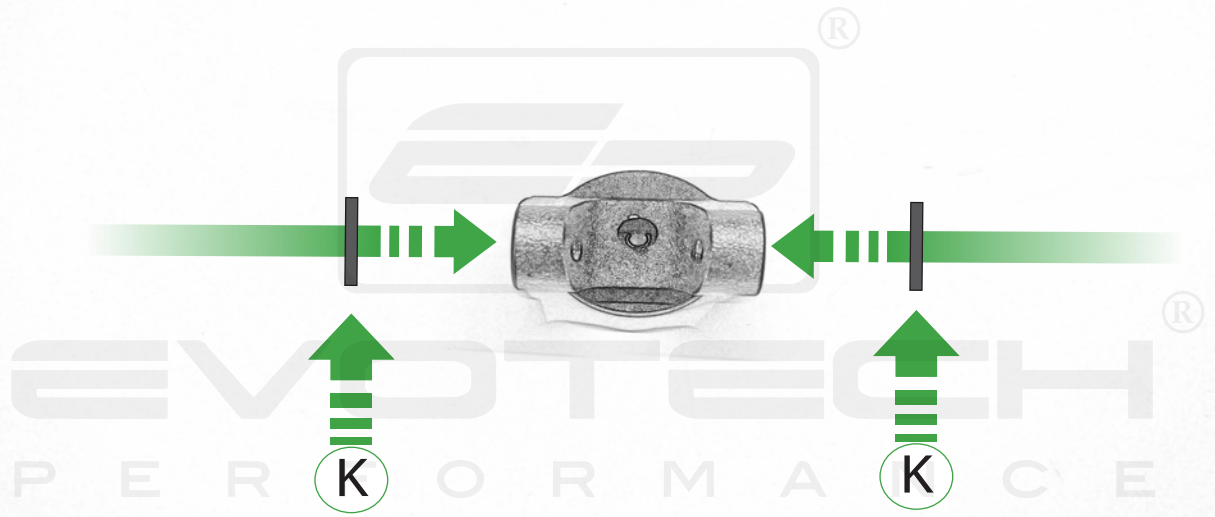



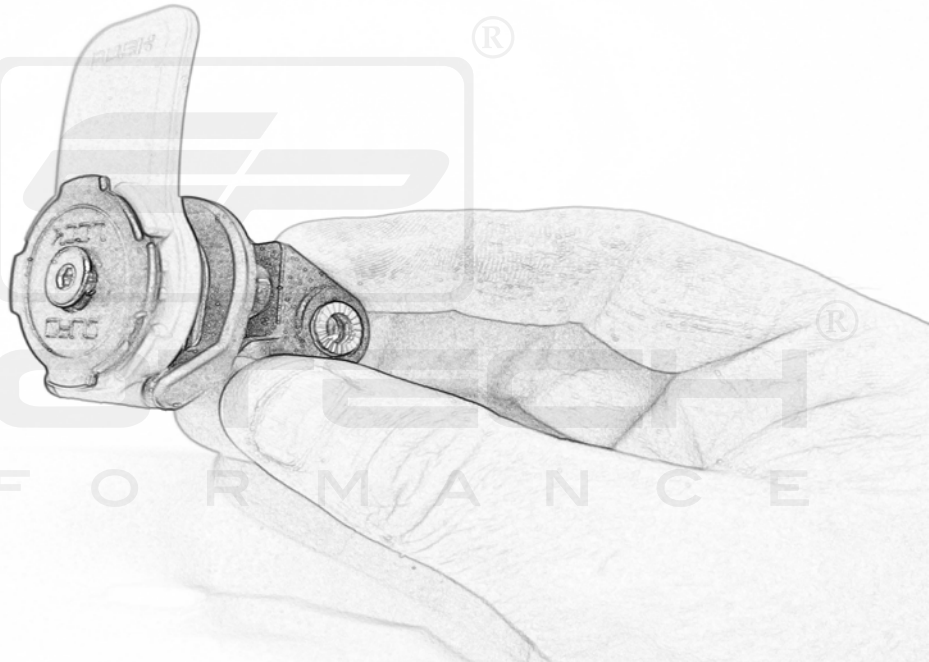

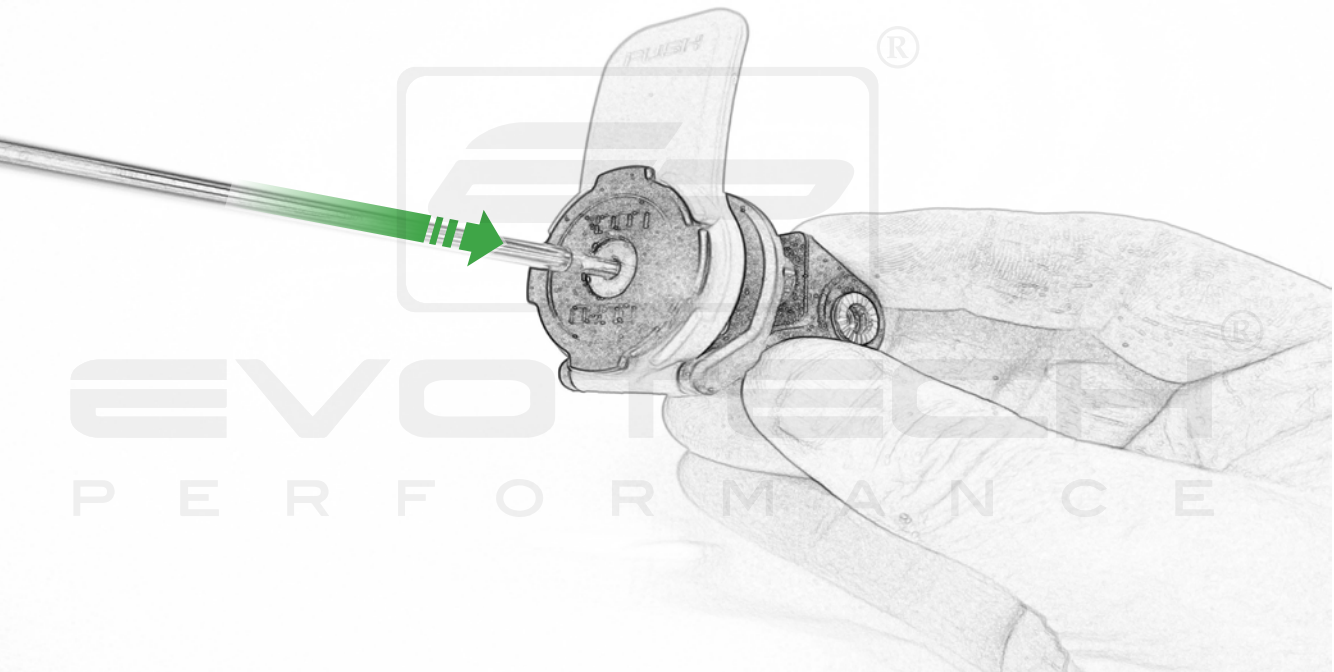

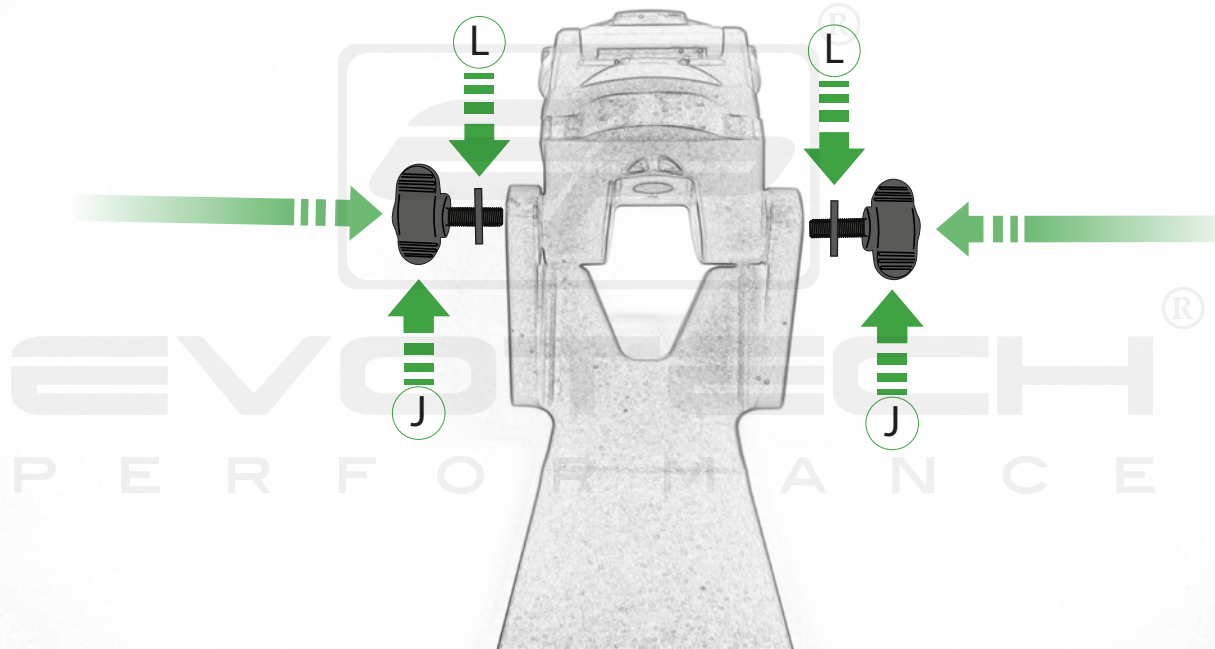

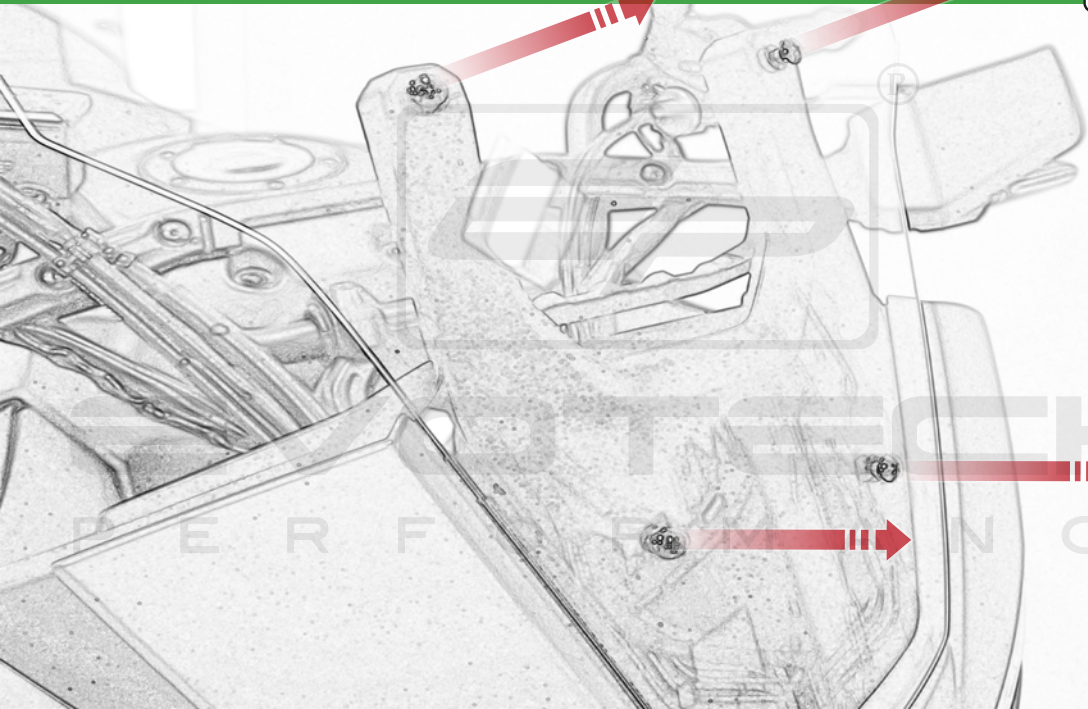

P E R F O R M A N C E

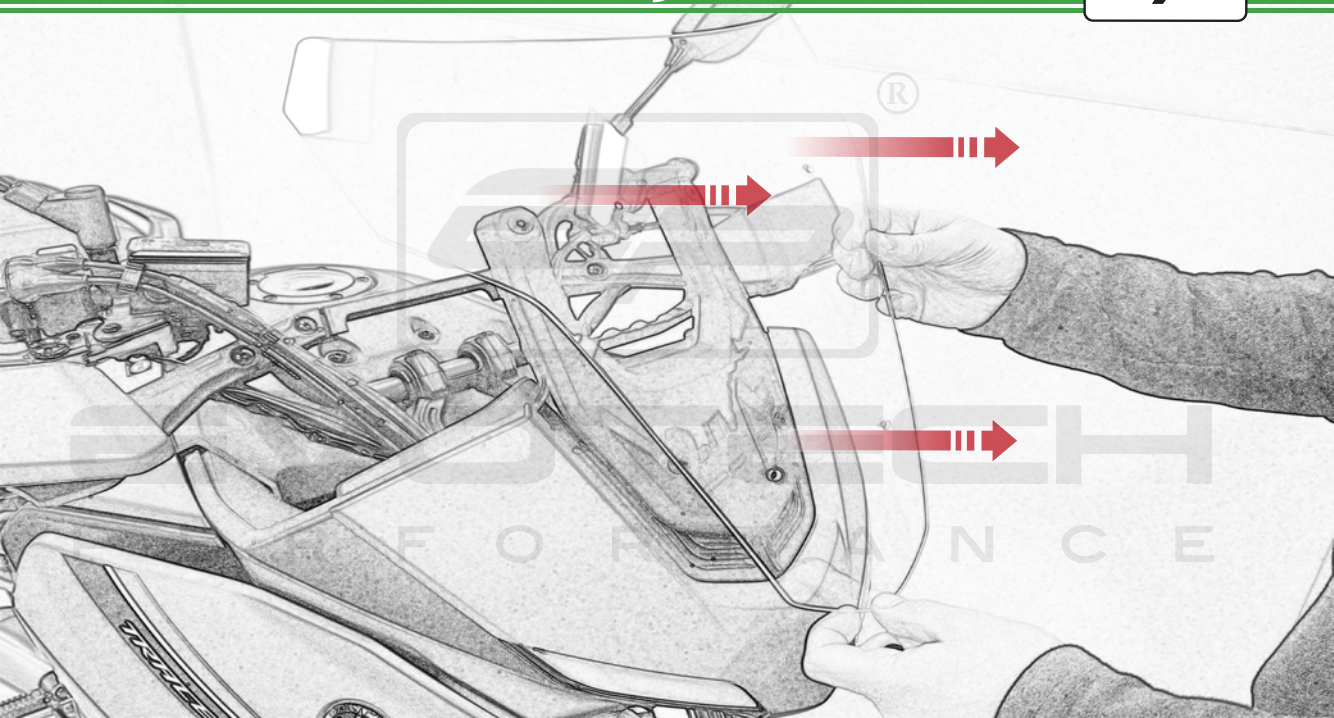

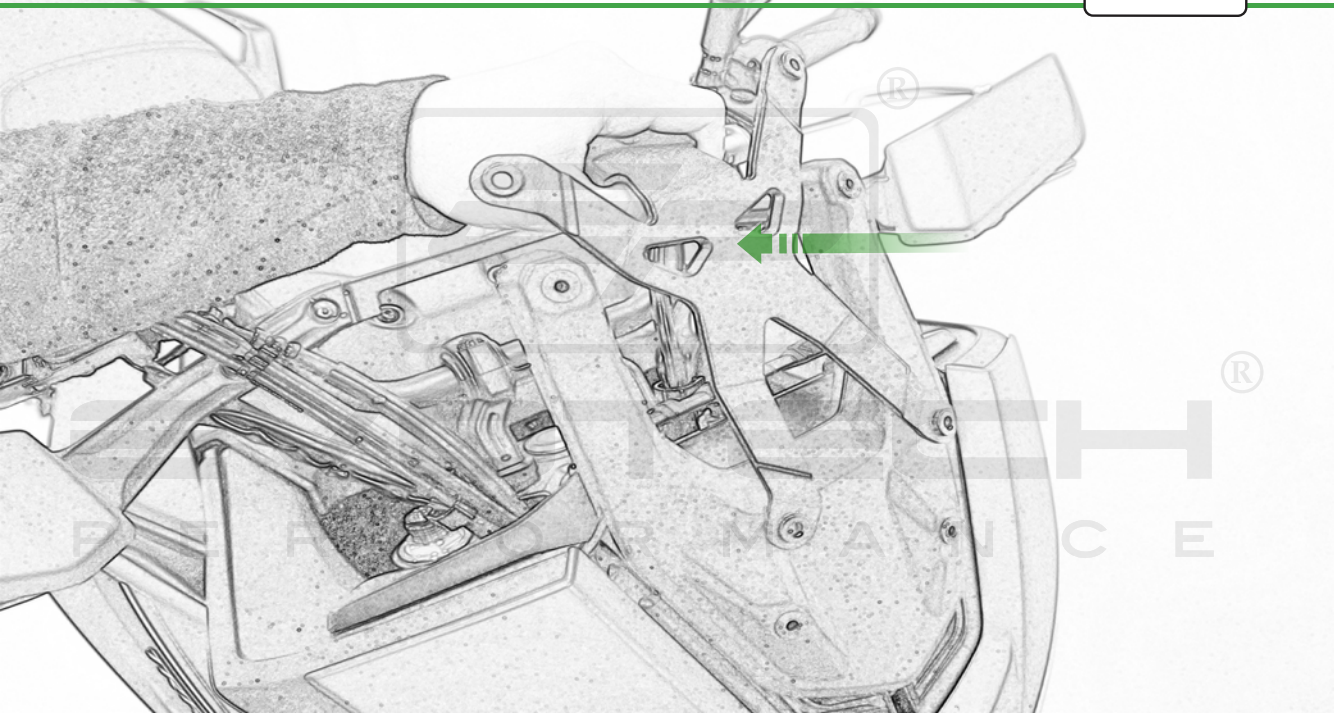

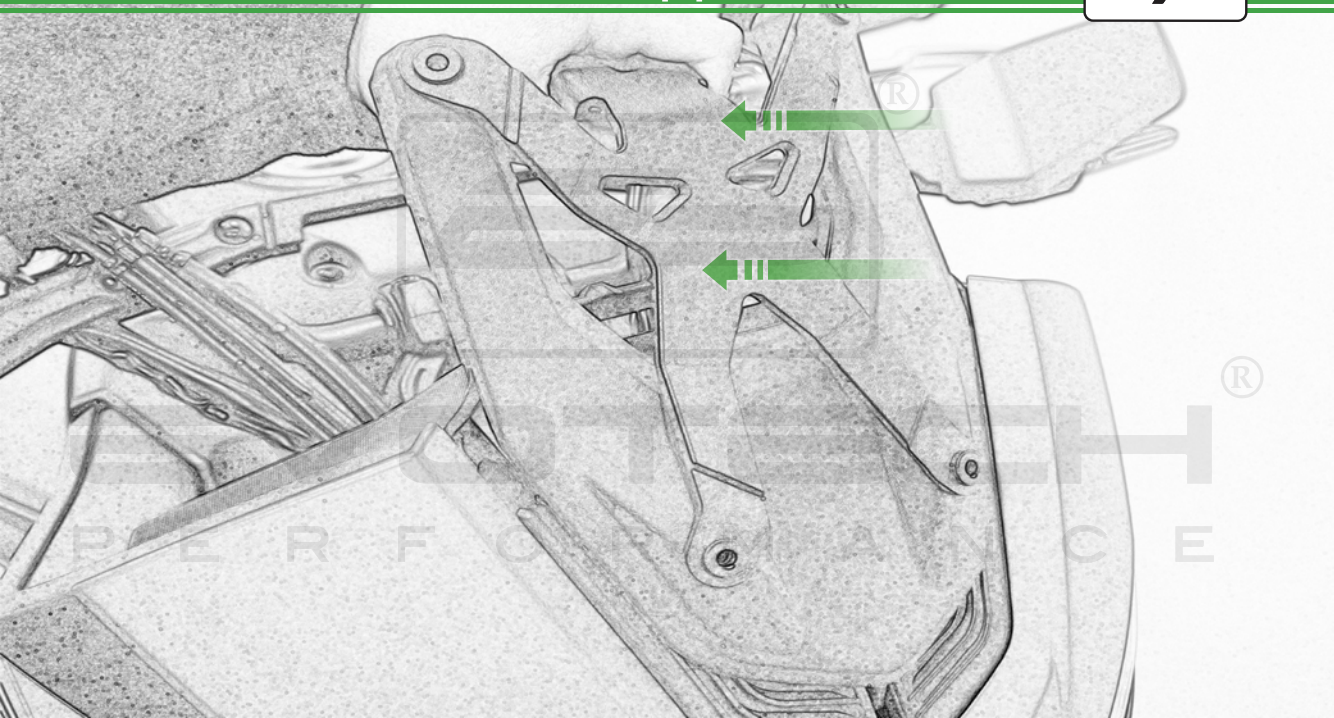

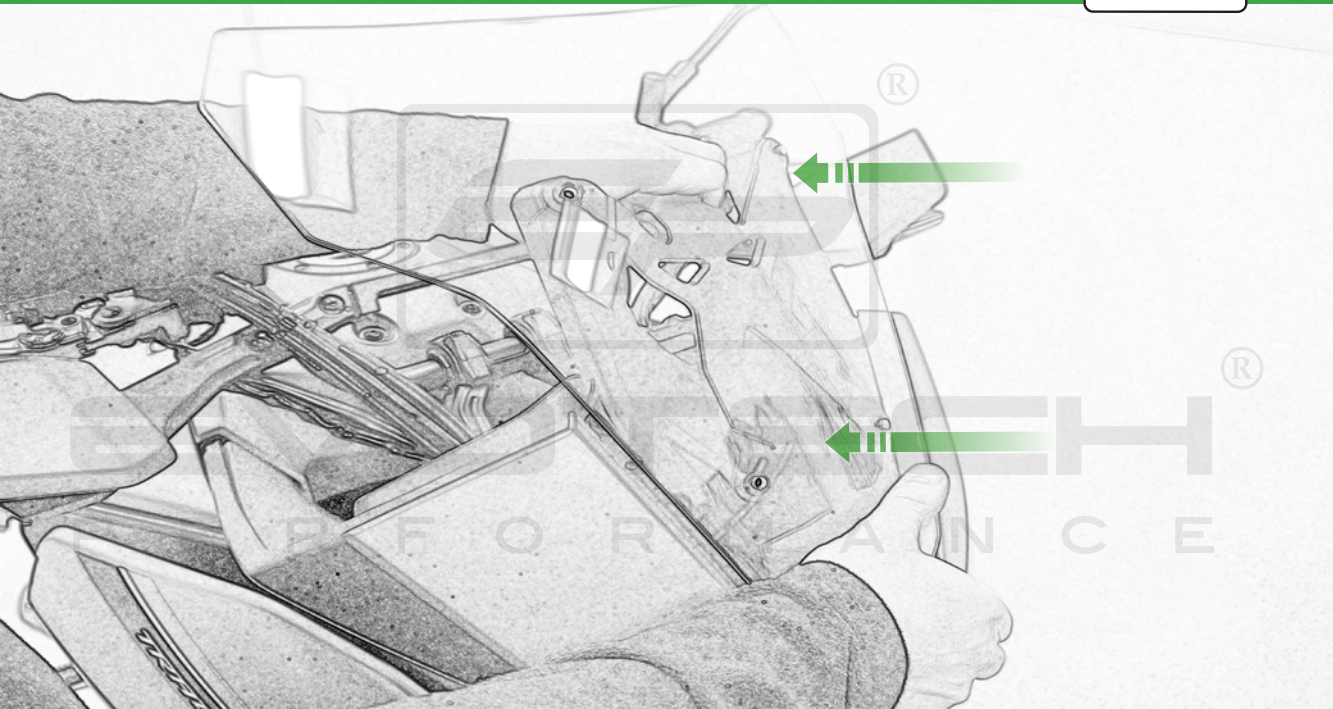

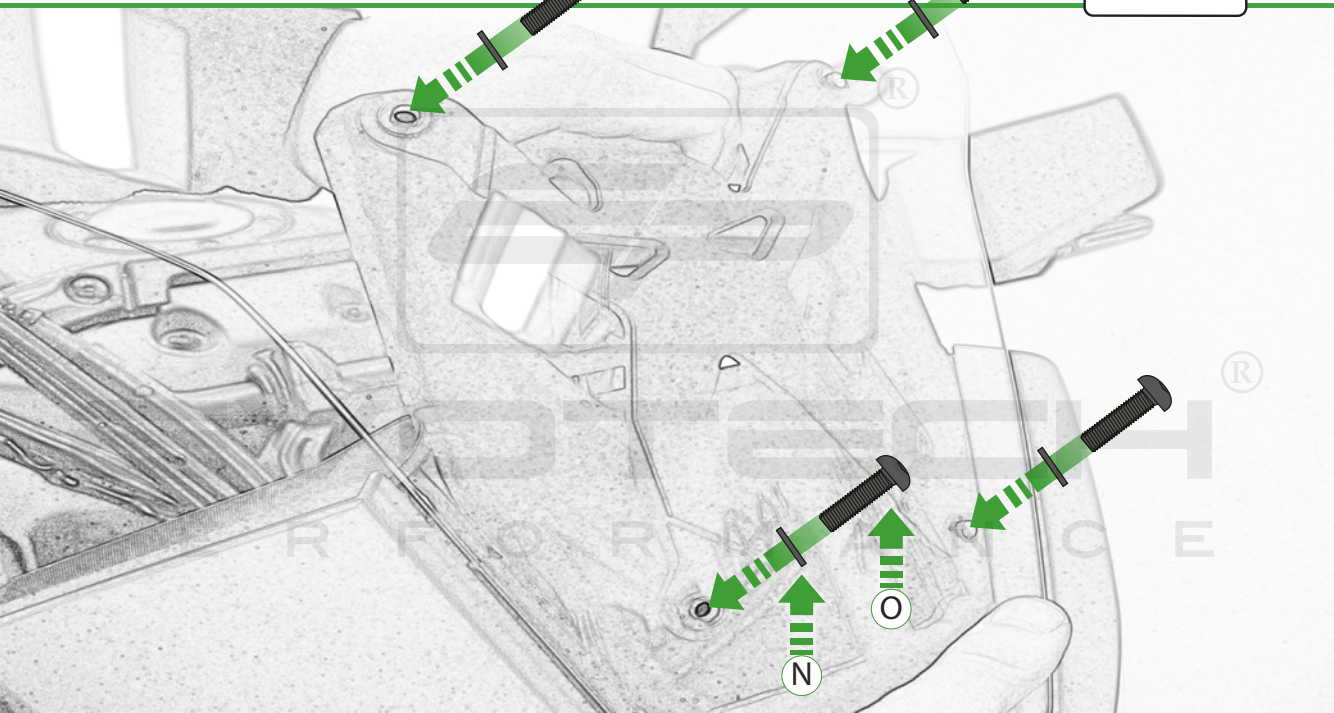



EVER
PERF
N



ESSENTIAL CHECKS

It is recommended that periodic inspections are made to ensure that all bolts are tightened to the specified torque settings.

Should the bike be involved in an accident a thorough inspection should be made and any components that have taken an impact, no matter how small, be replaced

P E R F O R M A N C E



EVOTECH®
P E R F O R M A N C E

www.evotech-performance.com