



EVOTECH®
P E R F O R M A N C E

www.evotech-performance.com

Generic Bar Clamp

Tom Tom Sat Nav Mount Instruction



Kit Contents

- (A) 1 x Pivot Plate
- (B) 1 x Left Hand Arm
- (C) 1 x Right Hand Arm
- (D) 1 x Tom Tom Plate
- (E) 2 x Nord Lock Washer
- (F) 2 x M5 x 8mm Black Button Head Bolt
- (G) 2 x Spacer
- (H) 2 x M5 x 12 Caphead Bolt
- (I) 2 x M8 Caphead Bolt
- (J) 4 x M5 x 12mm Black Button Head Bolts

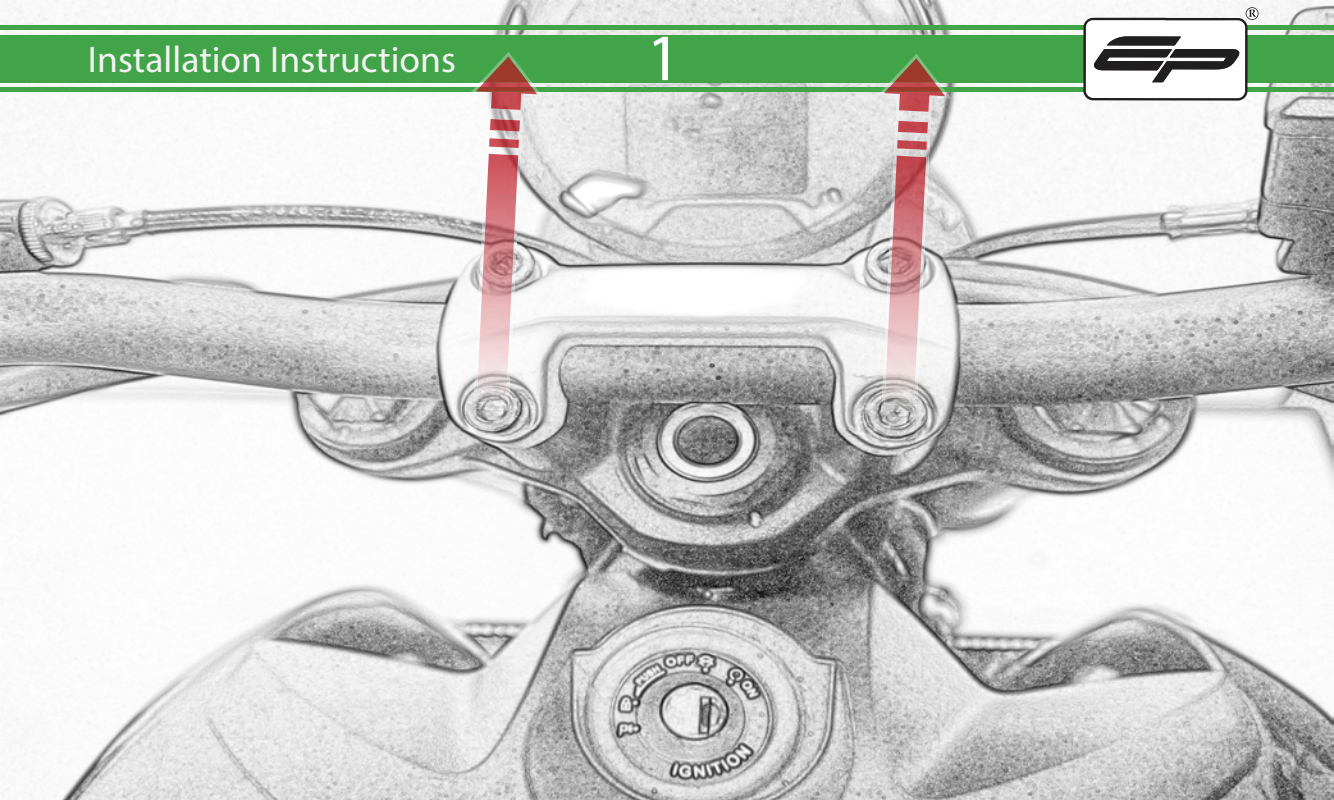

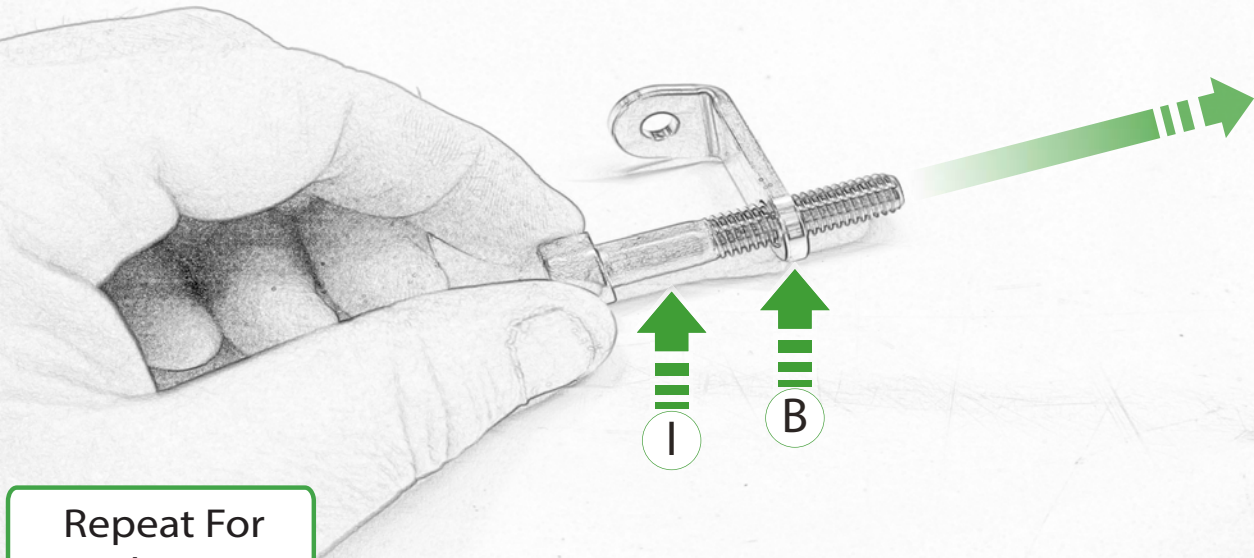

Repeat For
Both Arms

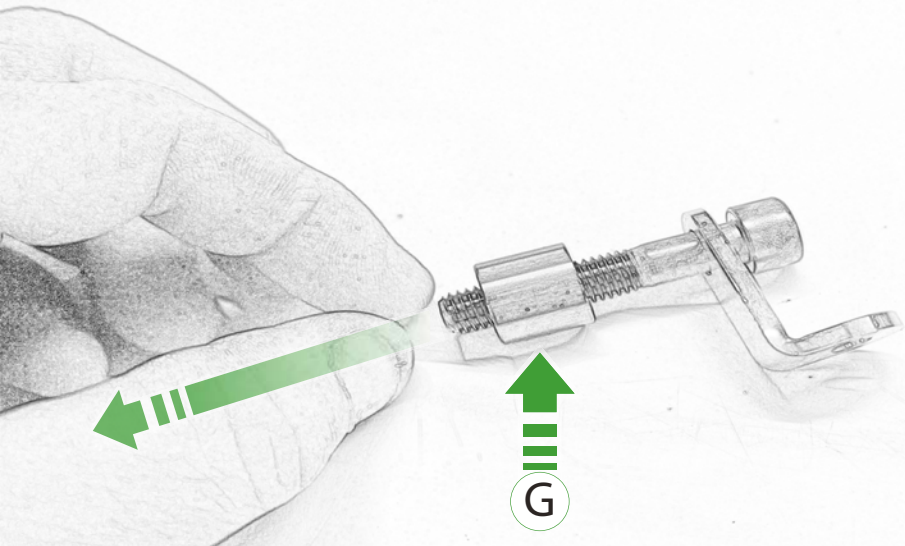

Repeat For
Both Arms

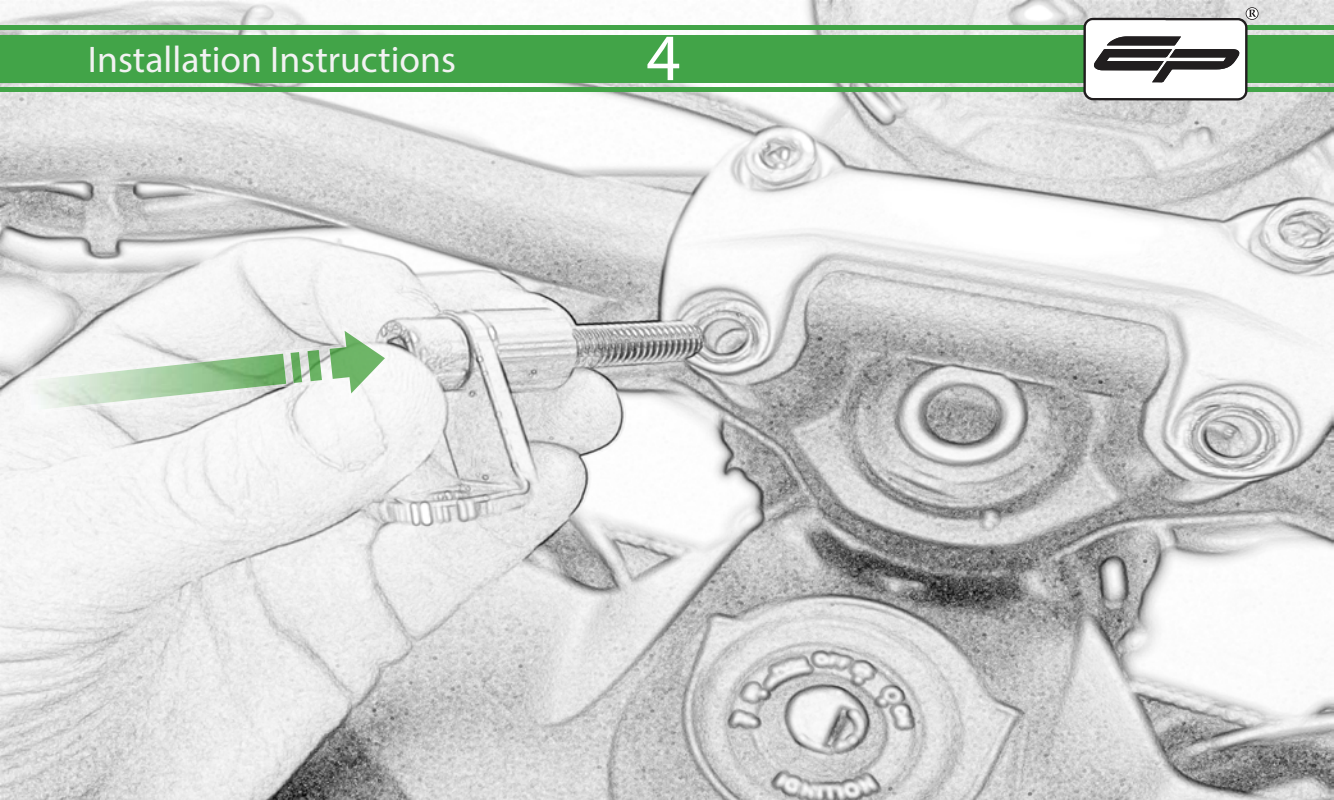

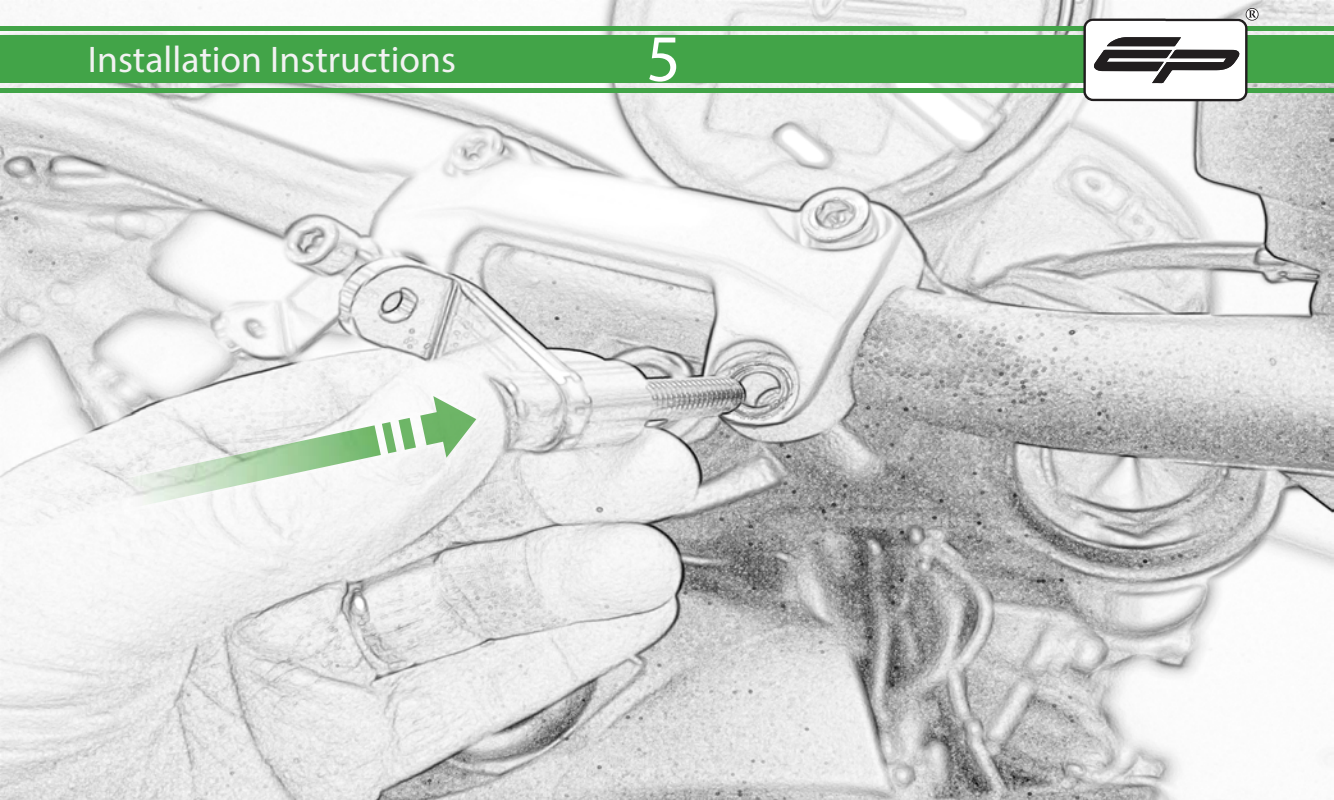

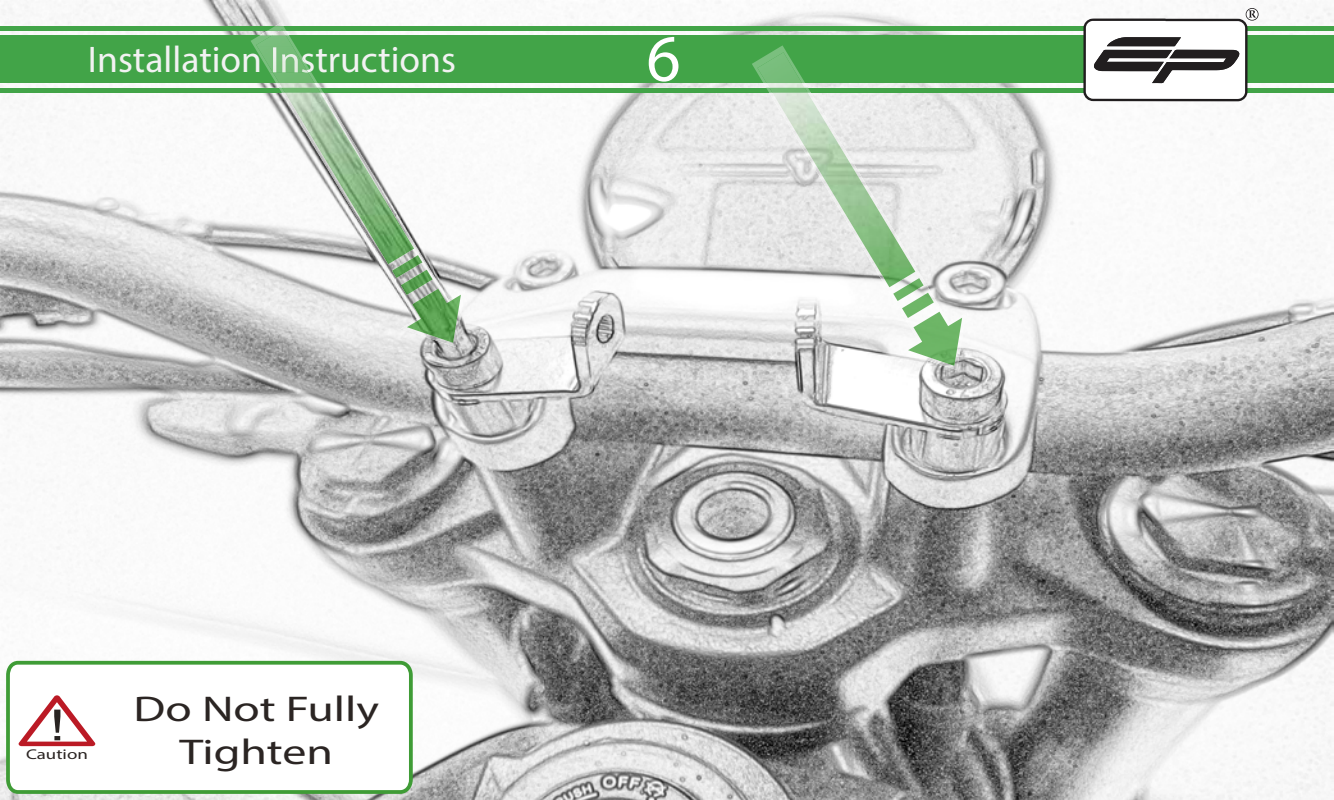

Do Not Fully Tighten

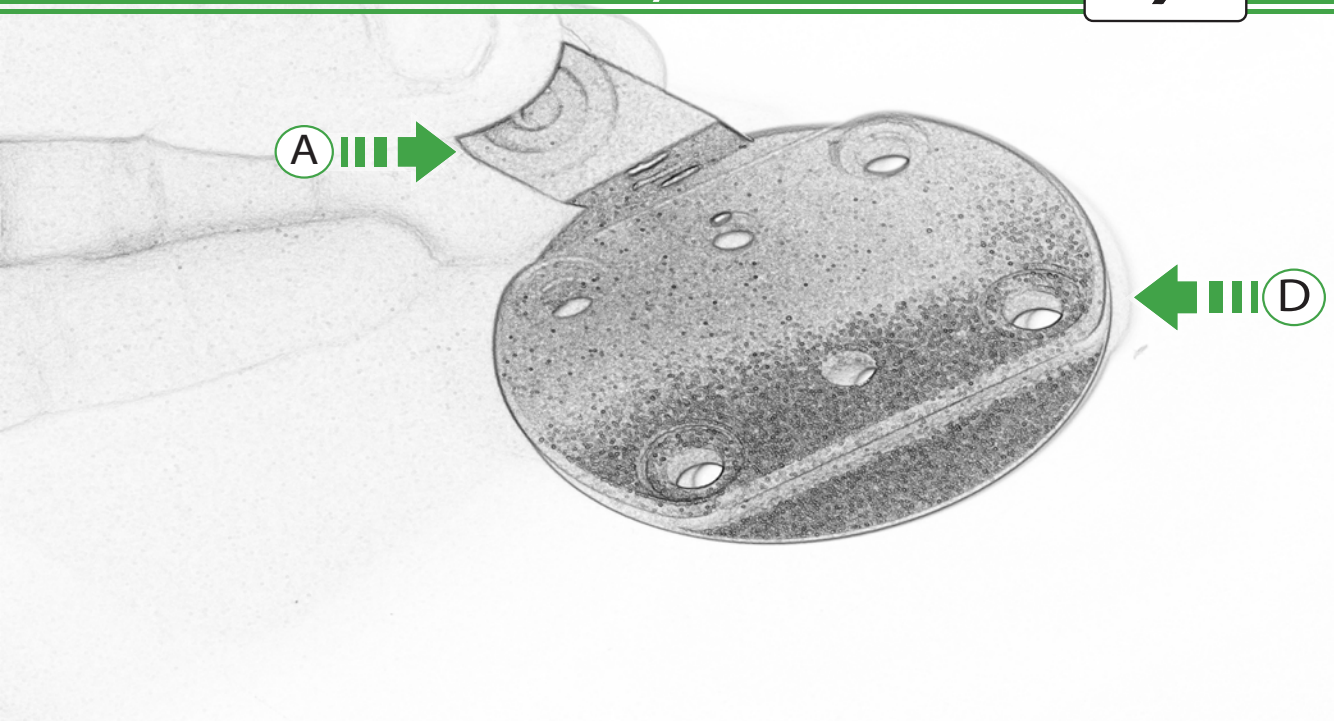

A

D

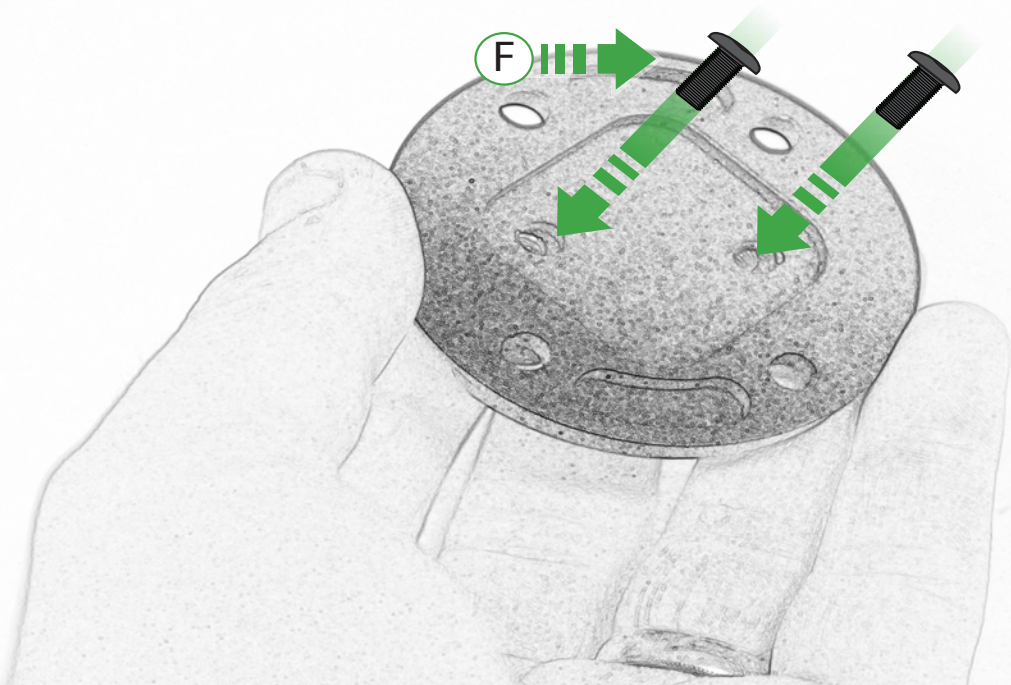

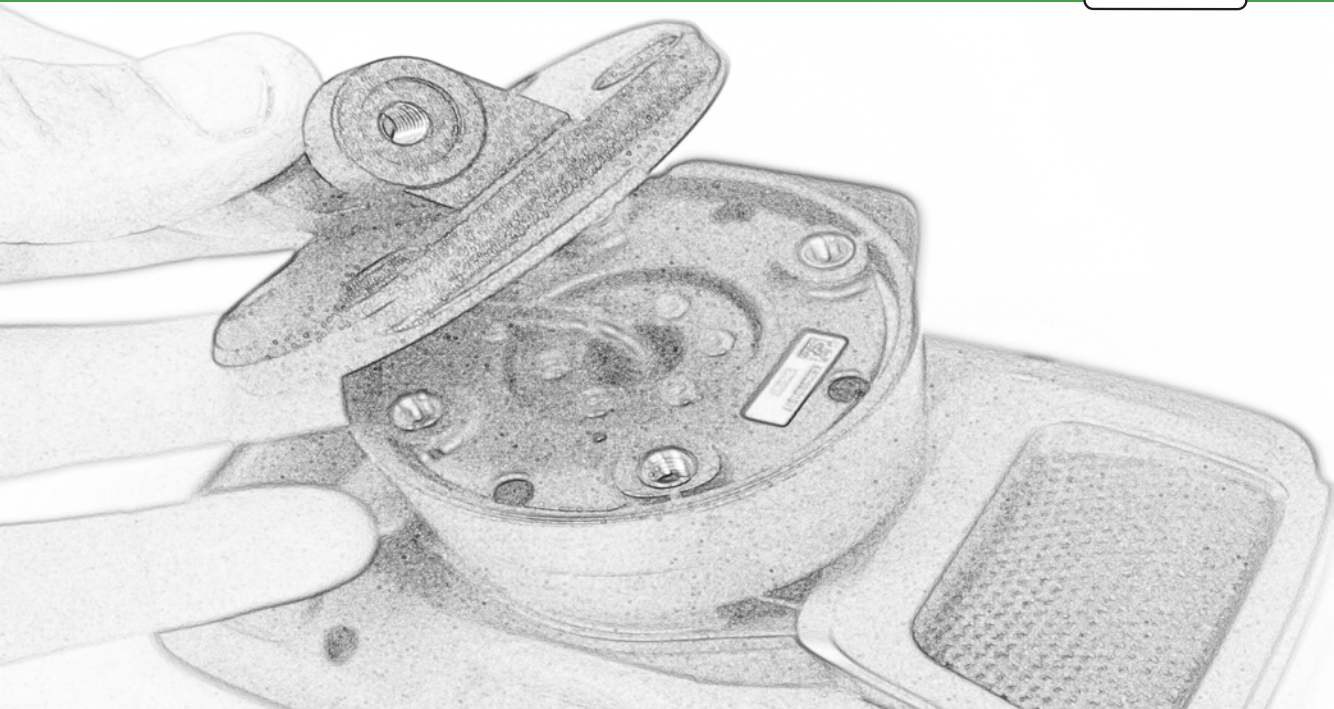

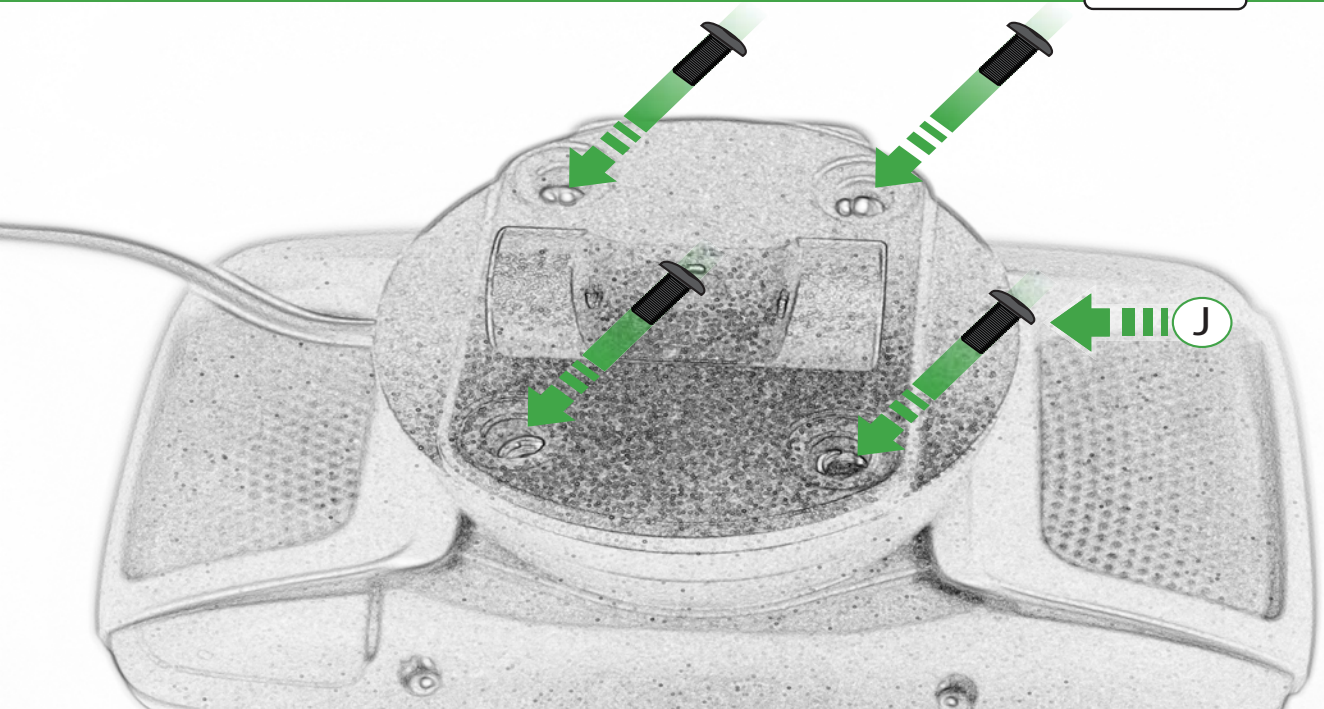

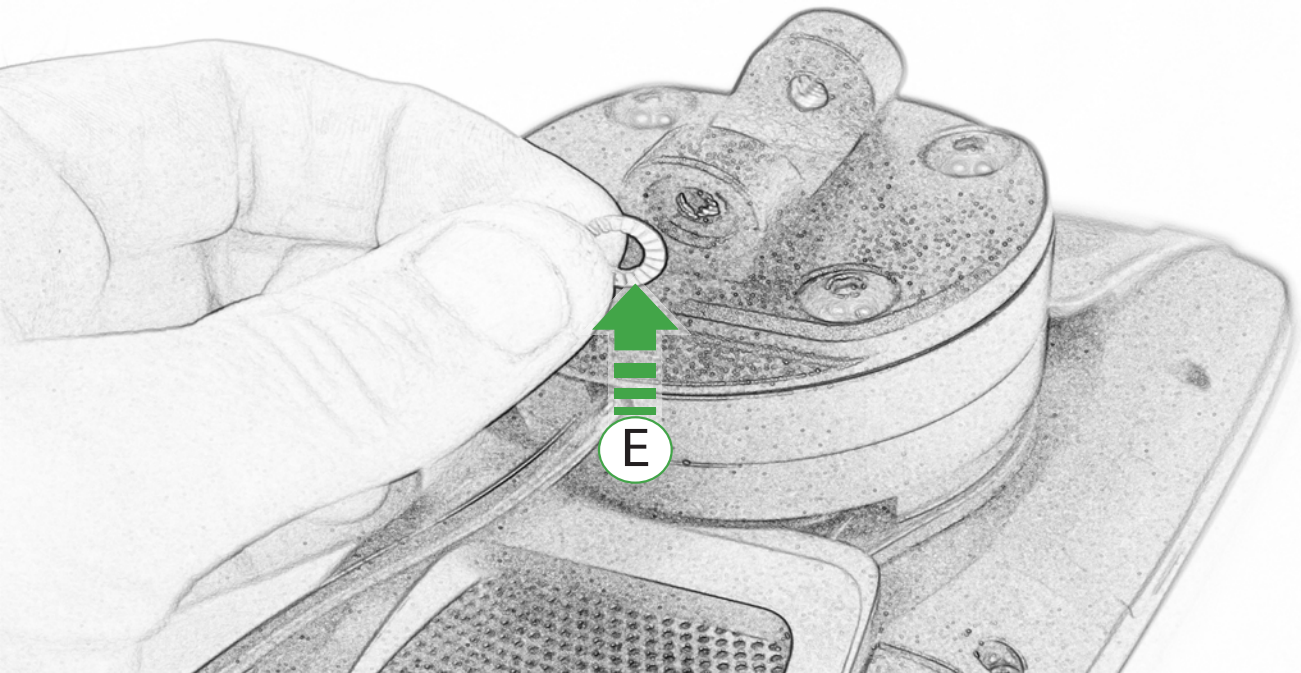

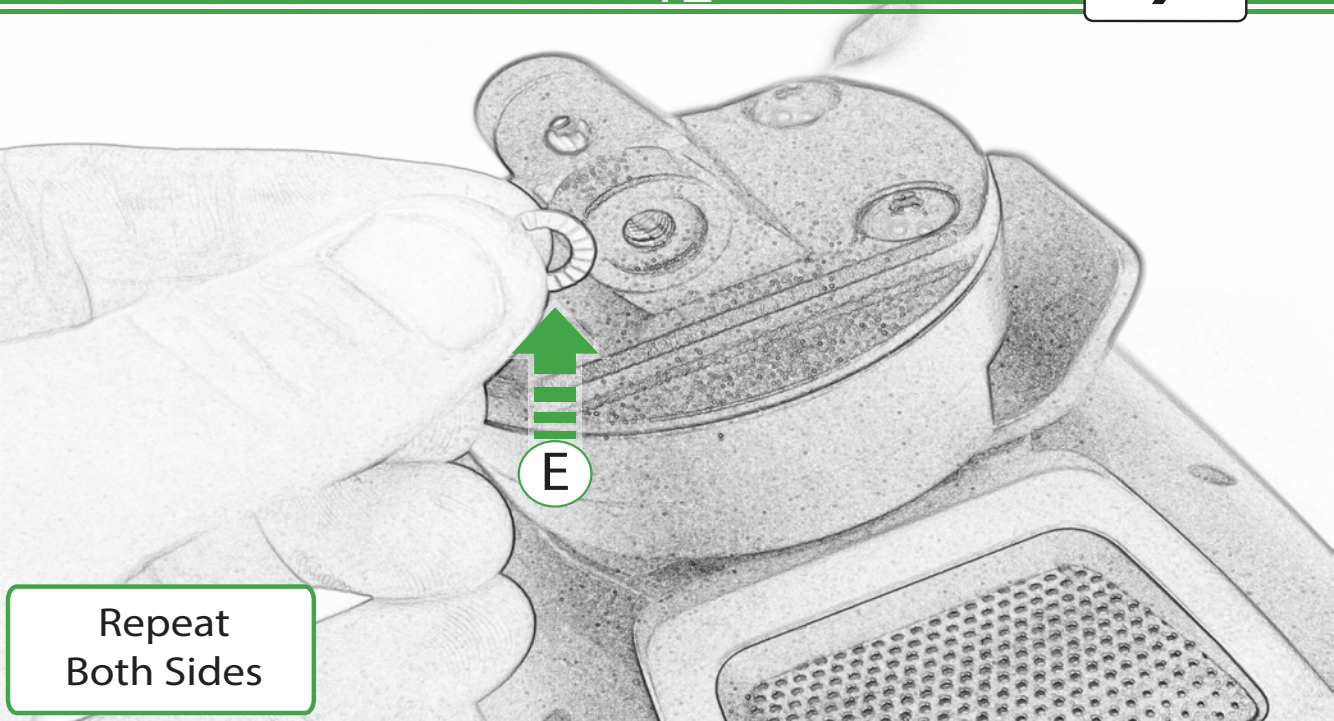

Repeat
Both Sides

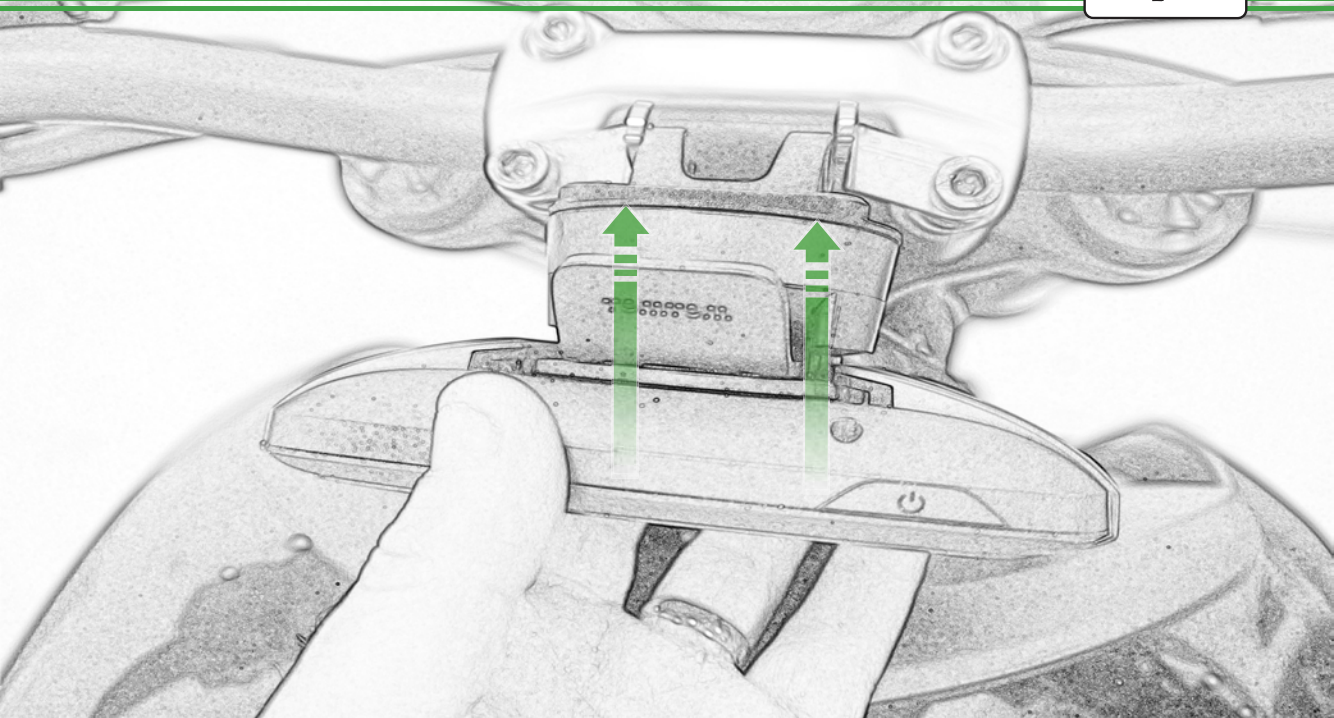

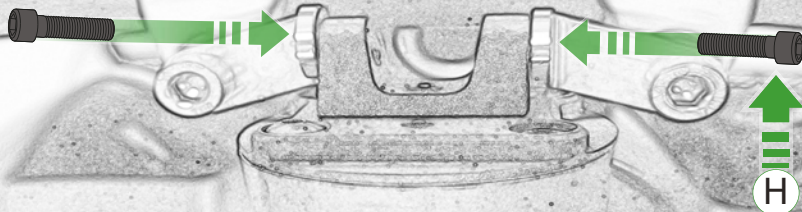

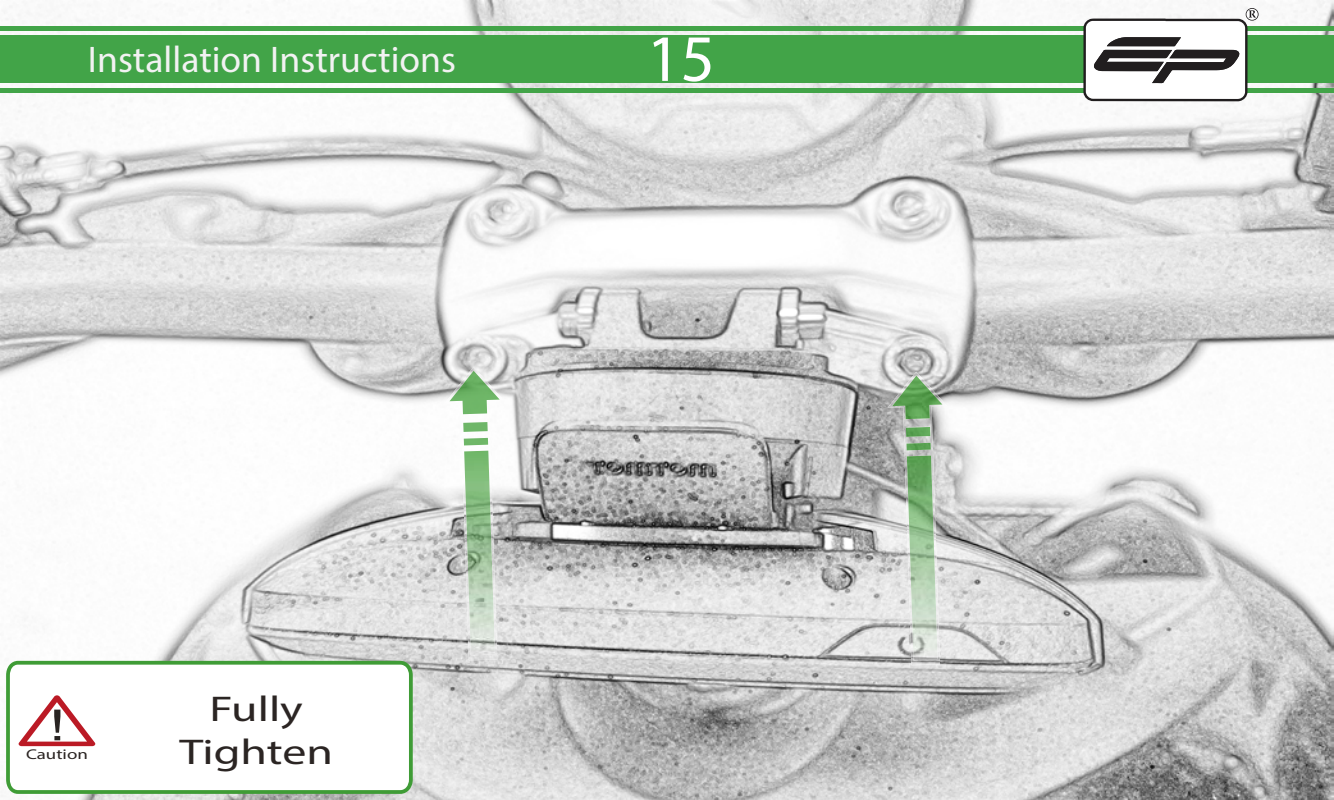

Fully
Tighten



ESSENTIAL CHECKS

It is recommended that periodic inspections are made to ensure that all bolts are tightened to the specified torque settings.

Should the bike be involved in an accident a thorough inspection should be made and any components that have taken an impact, no matter how small, be replaced



EVOTECH®
P E R F O R M A N C E

www.evotech-performance.com