



EVOTECH®
P E R F O R M A N C E

www.evotech-performance.com

Triumph Tiger 1200 Garmin Sat Nav Mount
Installation Instructions



Kit Contents PRN014516-014566

- (A) 1 x Main Plate
 - (B) 1 x Pivot Plate
 - (C) 1 x Sub Mounting Bracket
 - (D) 2 x M5 x 8mm Black Button Head Bolts
 - (E) 2 x P-clips (No.1)
 - (F) 2 x P-clips (No.2)
 - (G) 2 x P-clips (No.3)
 - (H) 2 x P-clips (No.4)
 - (I) 2 x Lobe Screw
 - (J) 2 x M5 Black Washer
 - (K) 2 x Locking Washer
 - (L) 2 x M4 x 5mm Black Button Head Bolts
 - (M) 4 x M4 x 10mm Black Button Head Bolts
- Sub Kit

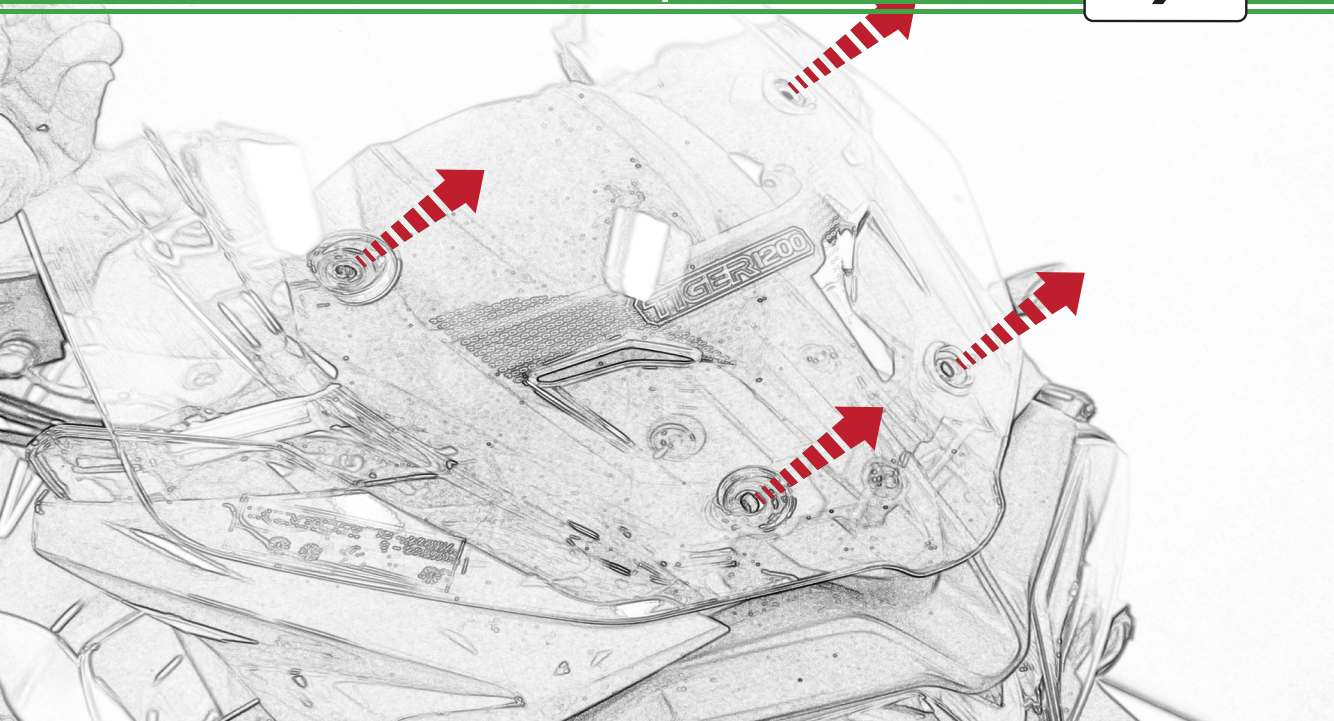

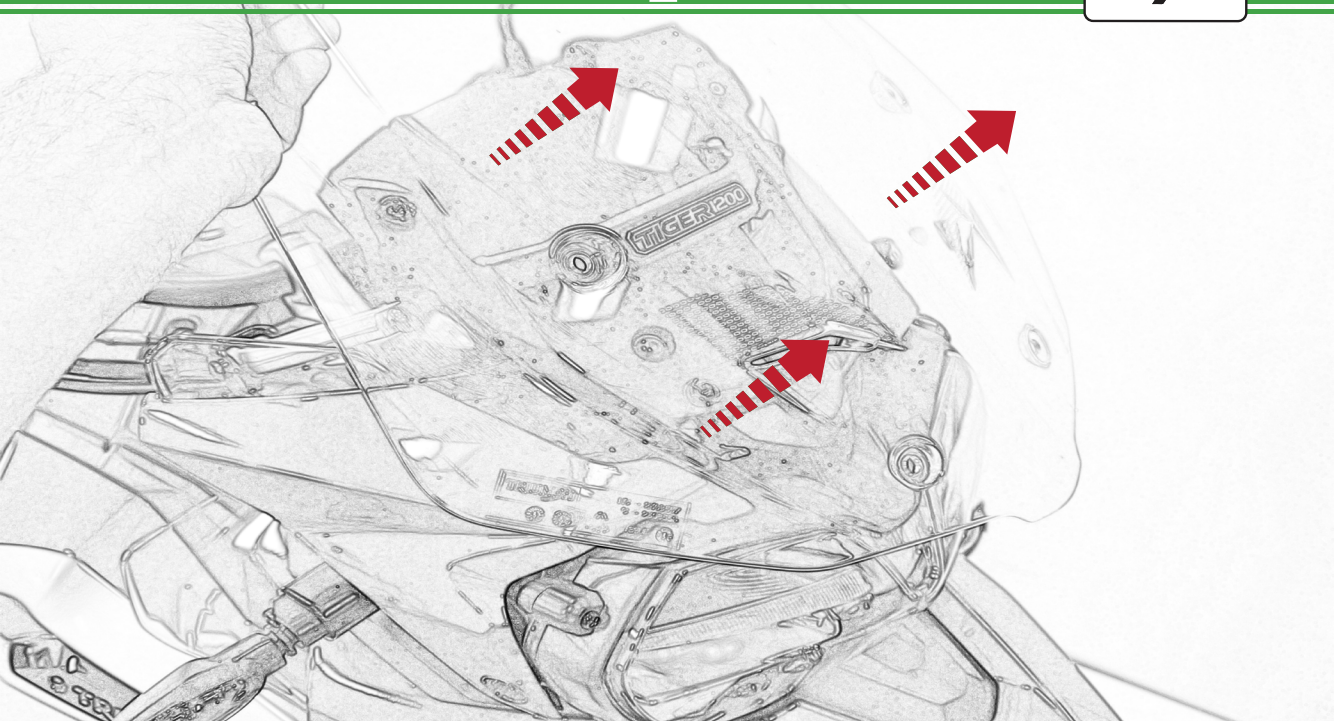

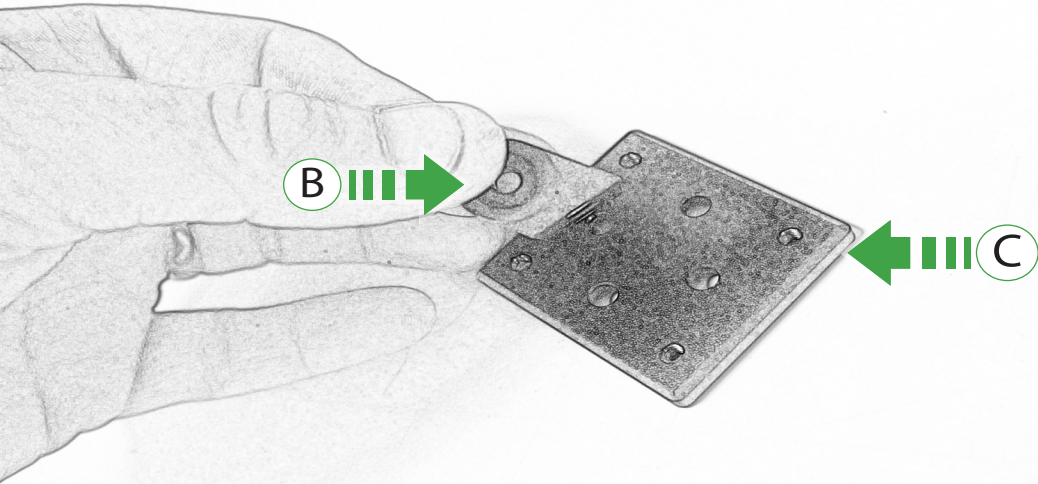

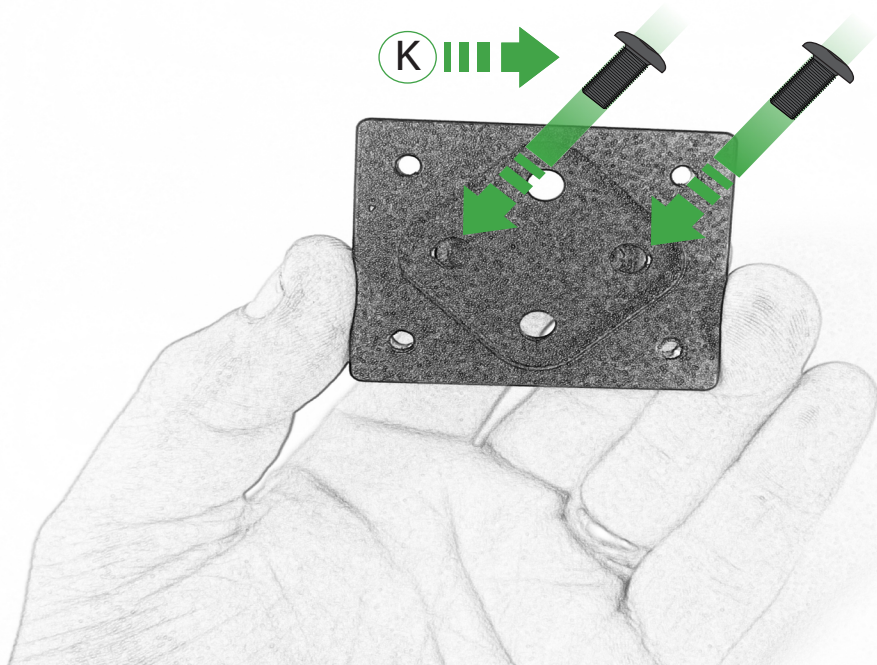

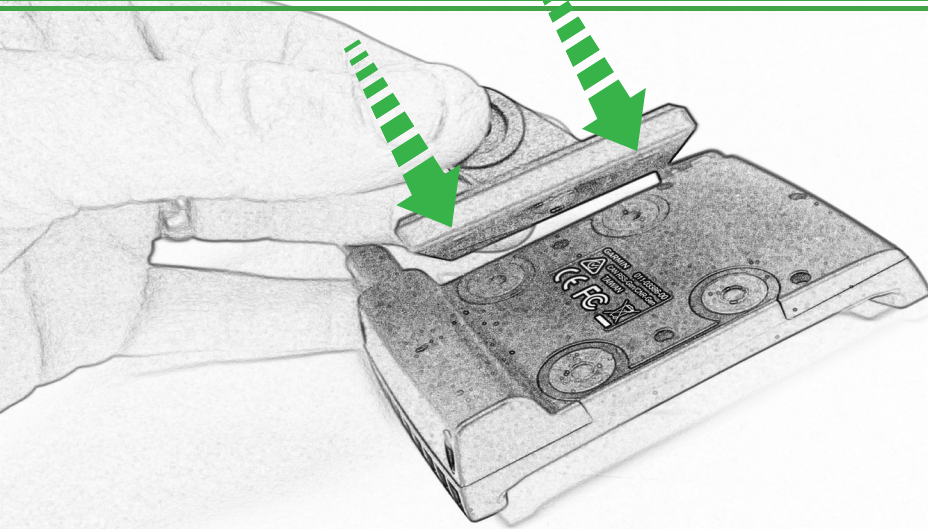

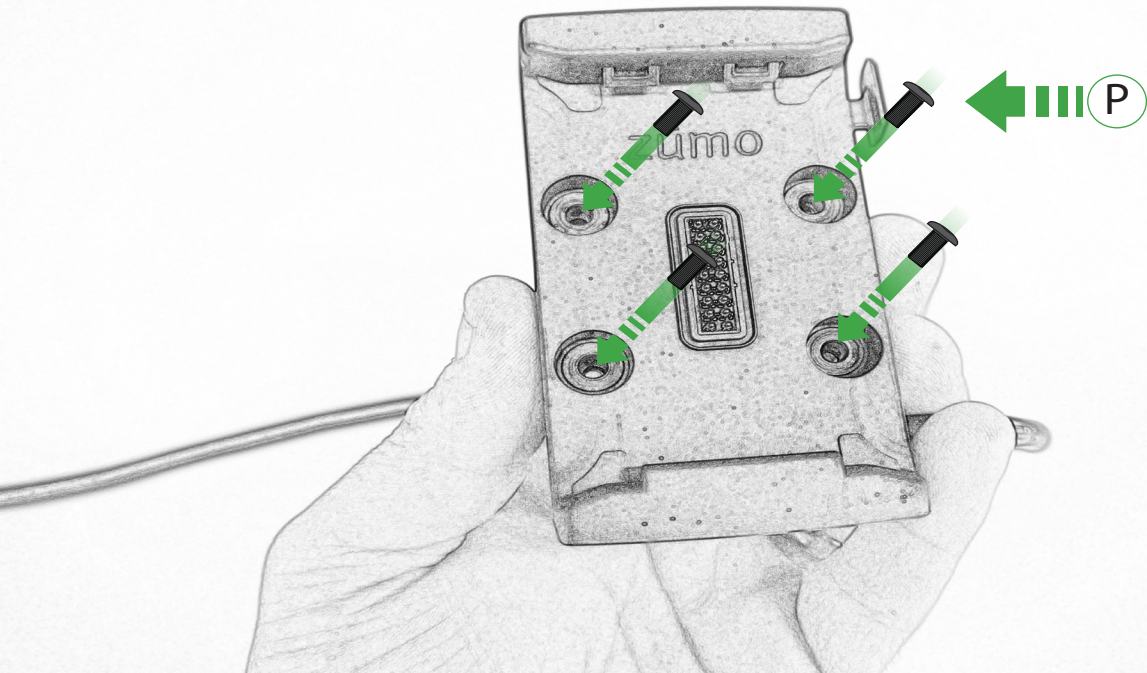

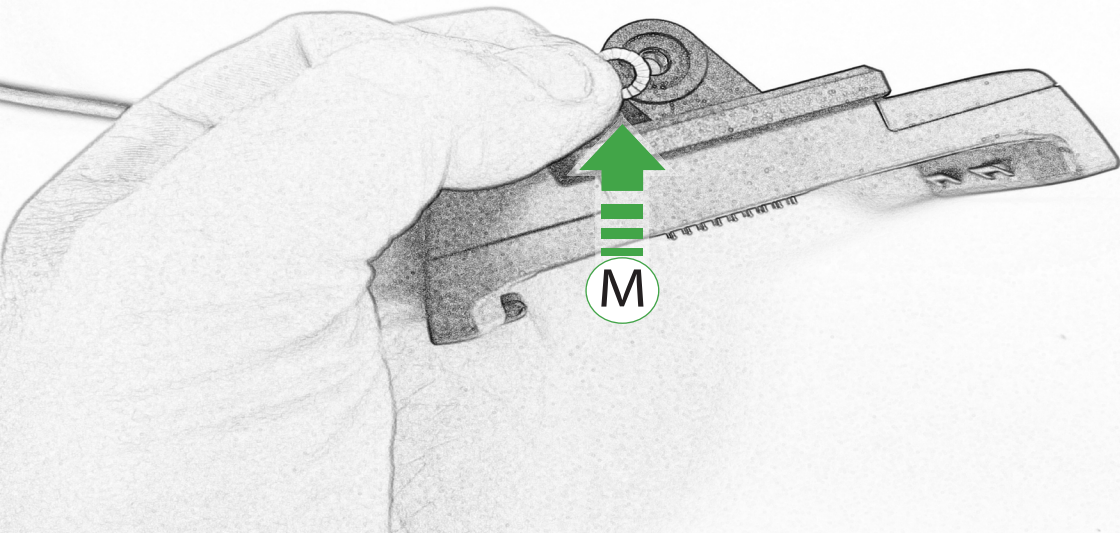

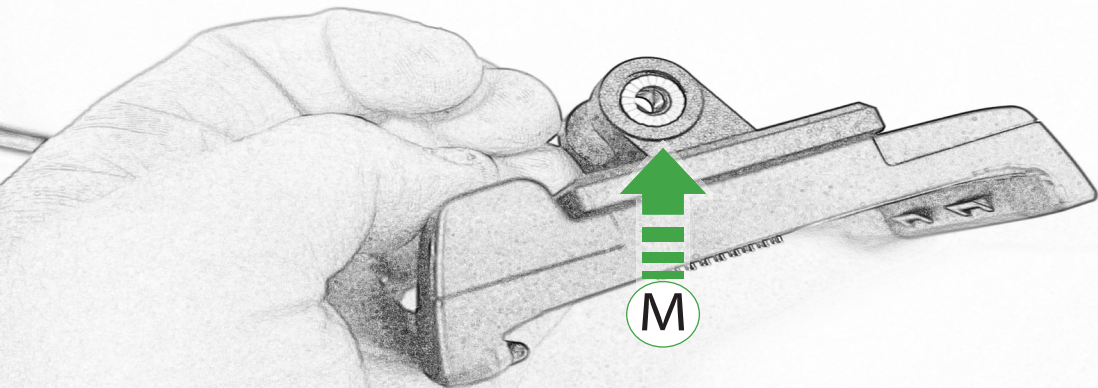

Repeat
Both Sides

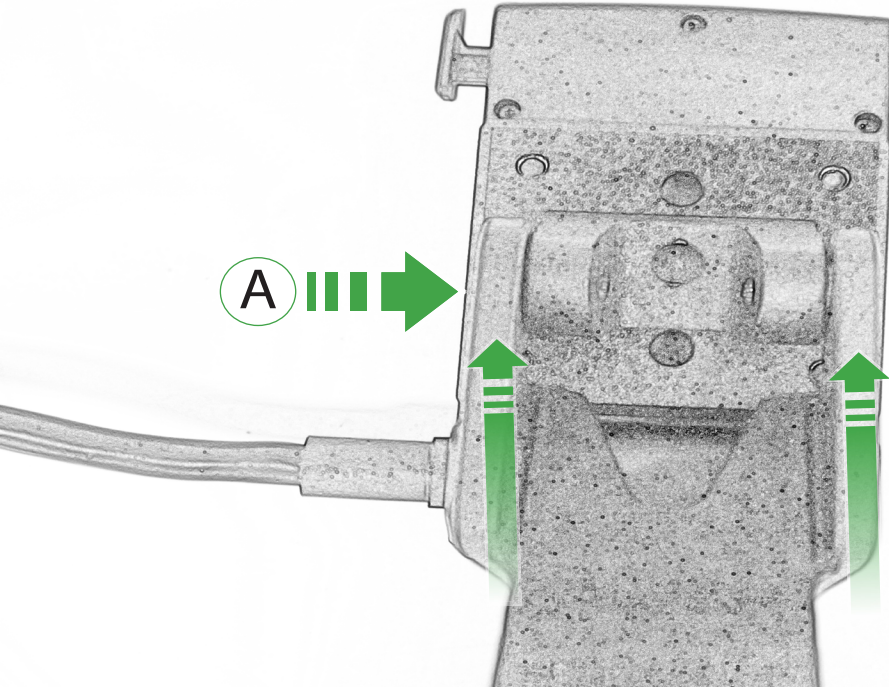

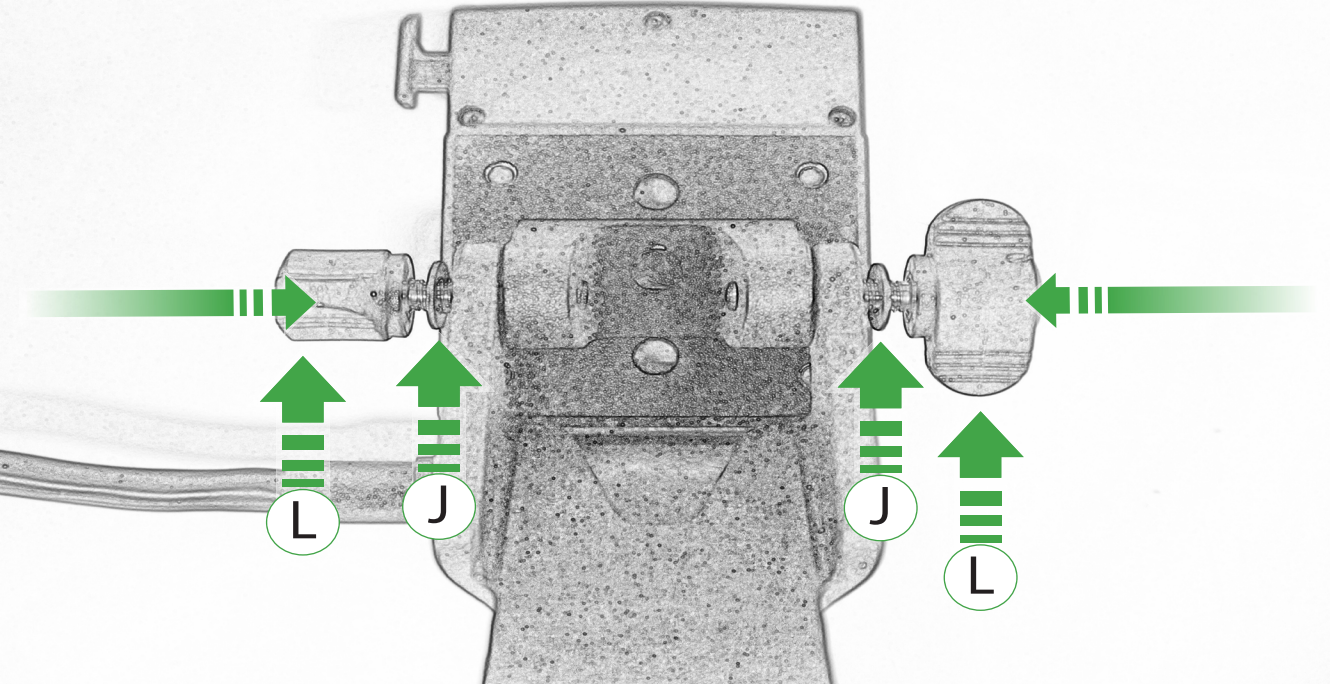

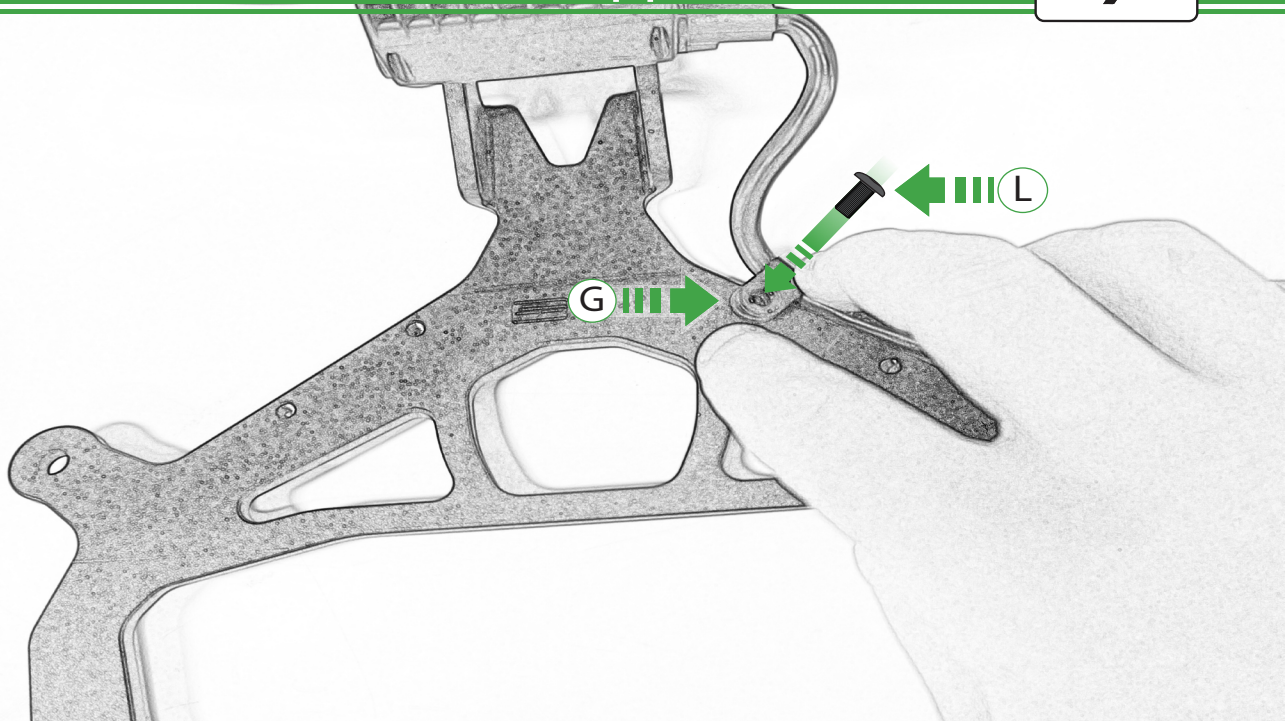

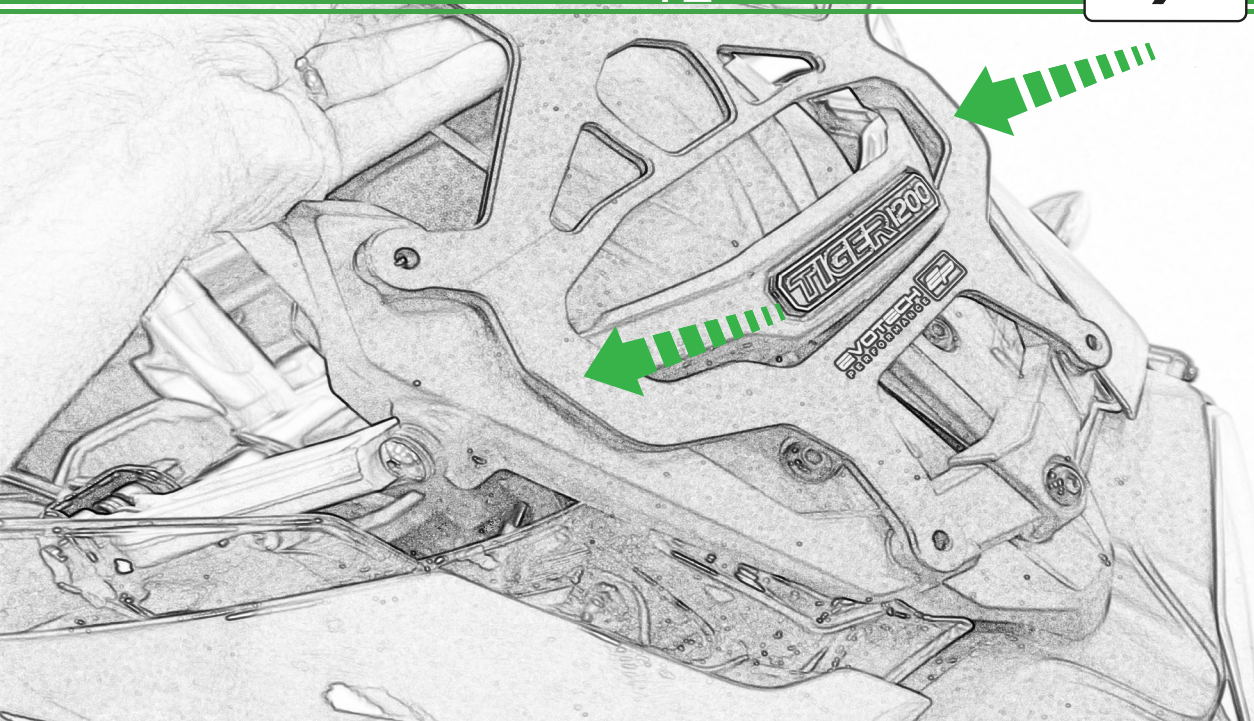

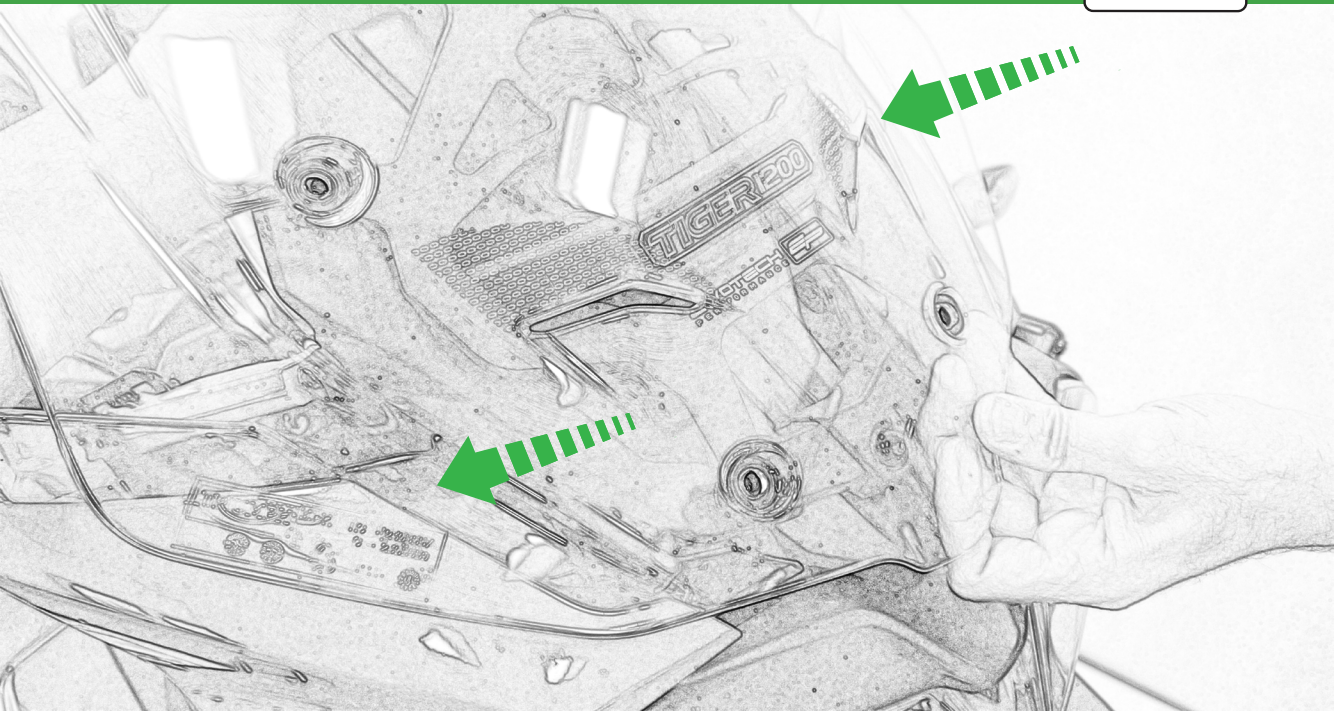



OEM PART

OEM PART

OEM PART

OEM PART

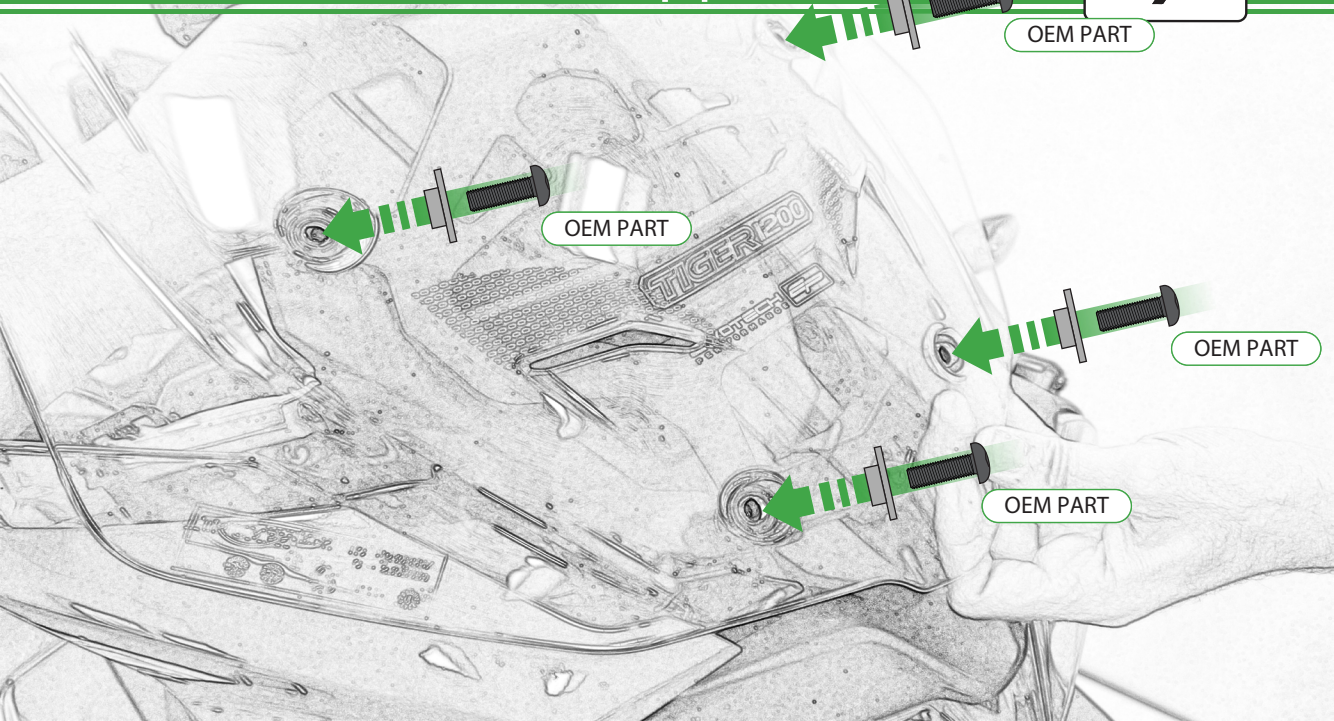



ESSENTIAL CHECKS

It is recommended that periodic inspections are made to ensure that all bolts are tightened to the specified torque settings.

Should the bike be involved in an accident a thorough inspection should be made and any components that have taken an impact, no matter how small, be replaced