



EVOTECH®
P E R F O R M A N C E

Triumph Tiger 1200

Garmin Sat Nav Mount

Installation Instructions



Kit Contents PRN014503-014566

- (A) 1 x Main Plate
 - (B) 1 x Pivot Plate
 - (C) 1 x Sub Mounting Bracket
 - (D) 2 x M5 x 8mm Black Button Head Bolts
 - (E) 2 x P-clips (No.1)
 - (F) 2 x P-clips (No.2)
 - (G) 2 x P-clips (No.3)
 - (H) 2 x P-clips (No.4)
 - (I) 2 x Lobe Screw
 - (J) 2 x M5 Black Washer
 - (K) 2 x Locking Washer
 - (L) 2 x M4 x 5mm Black Button Head Bolts
 - (M) 4 x M4 x 10mm Black Button Head Bolts
- Sub Kit
- (N) 2 x M5 x 25mm Black Button head Bolts
 - (O) 2 x Nylon Washers

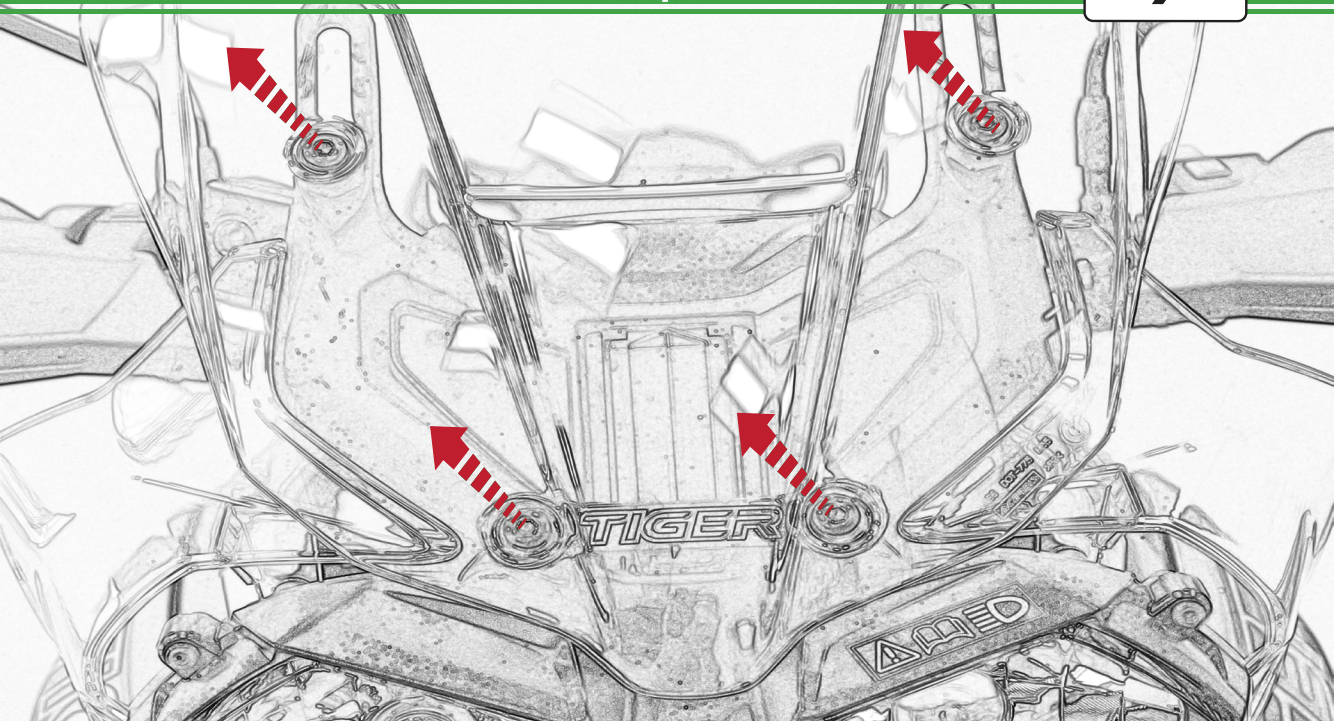

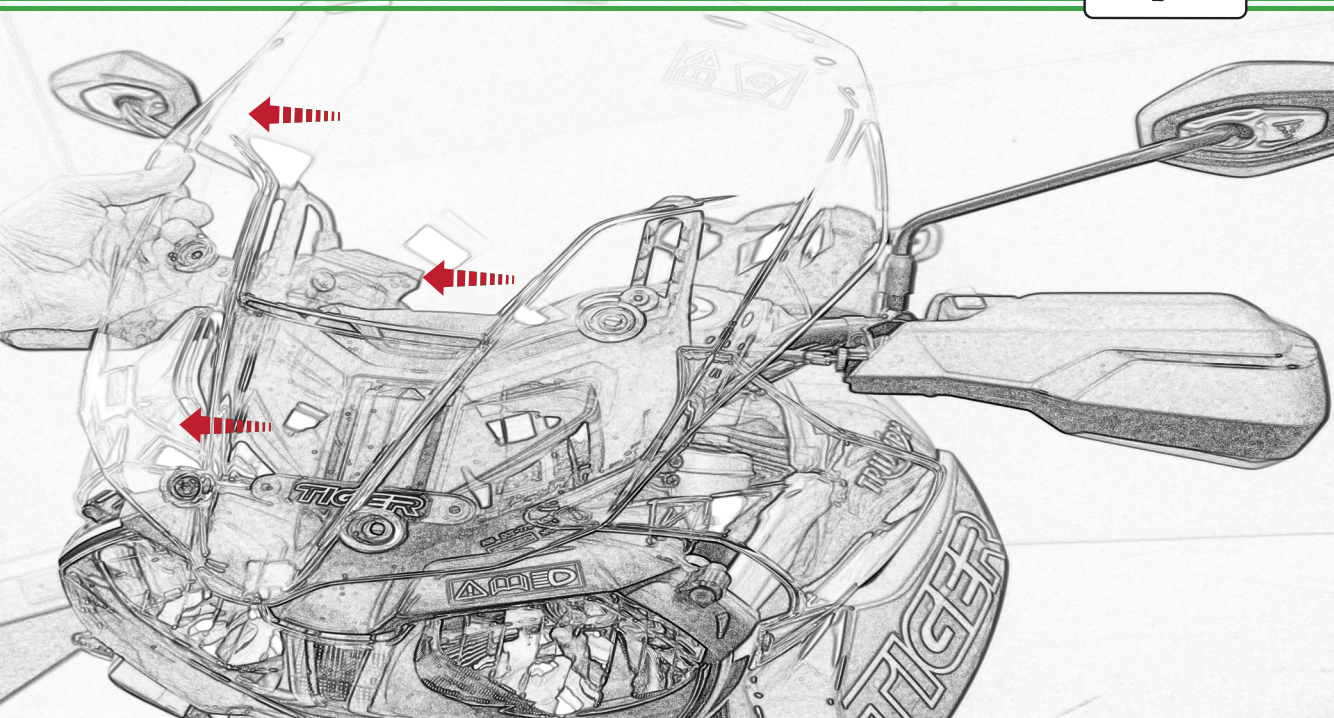

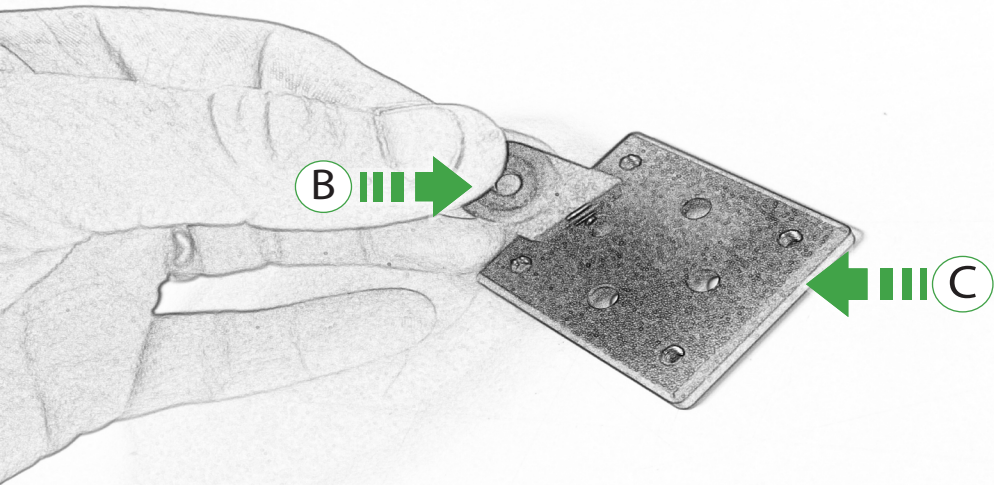

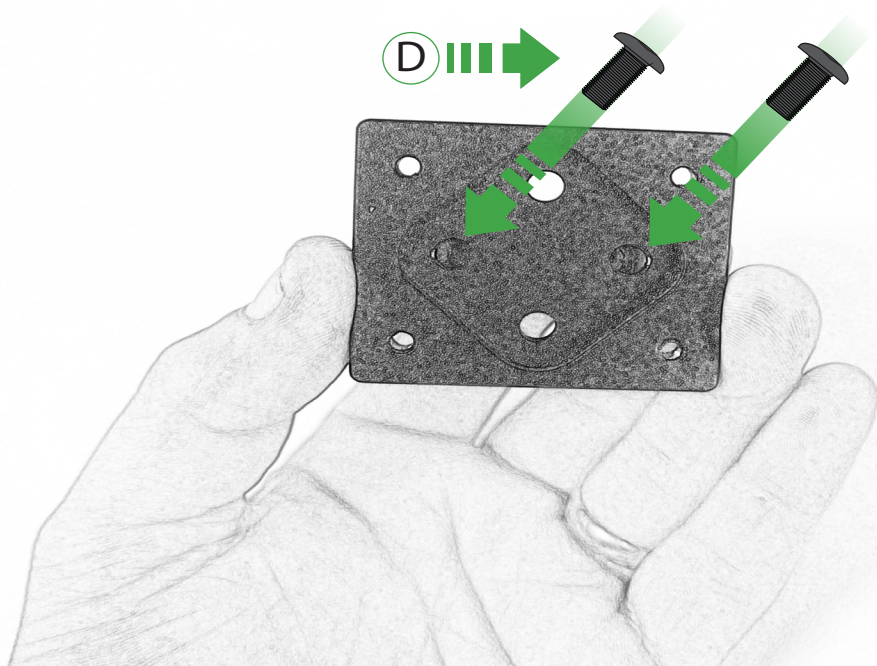



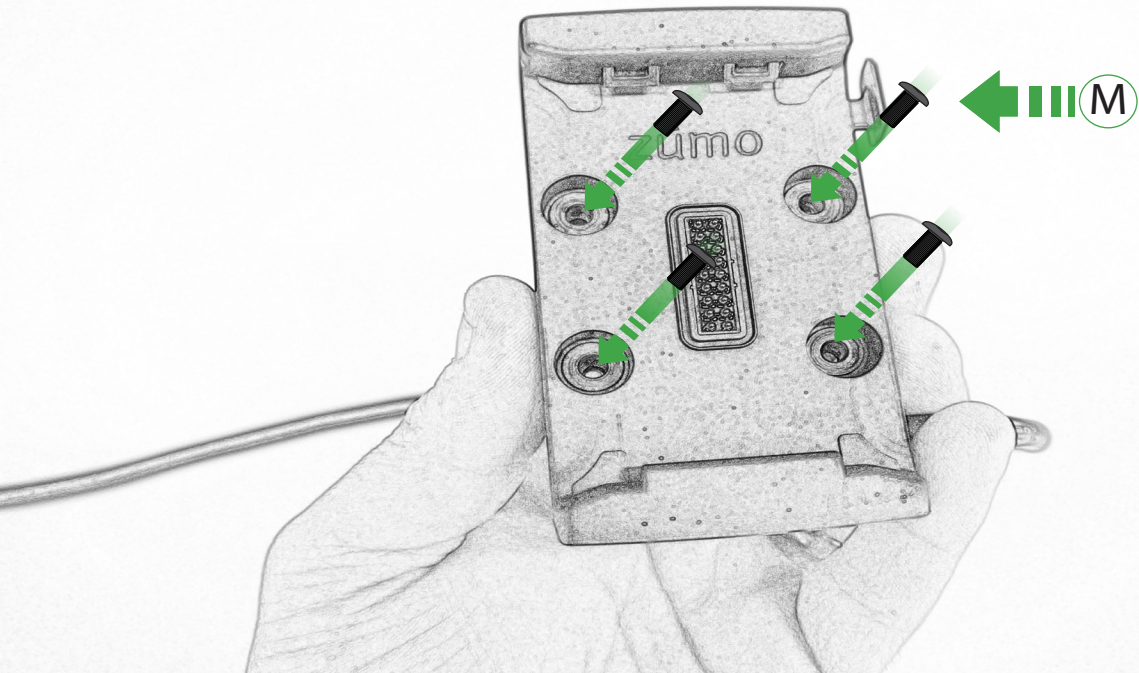

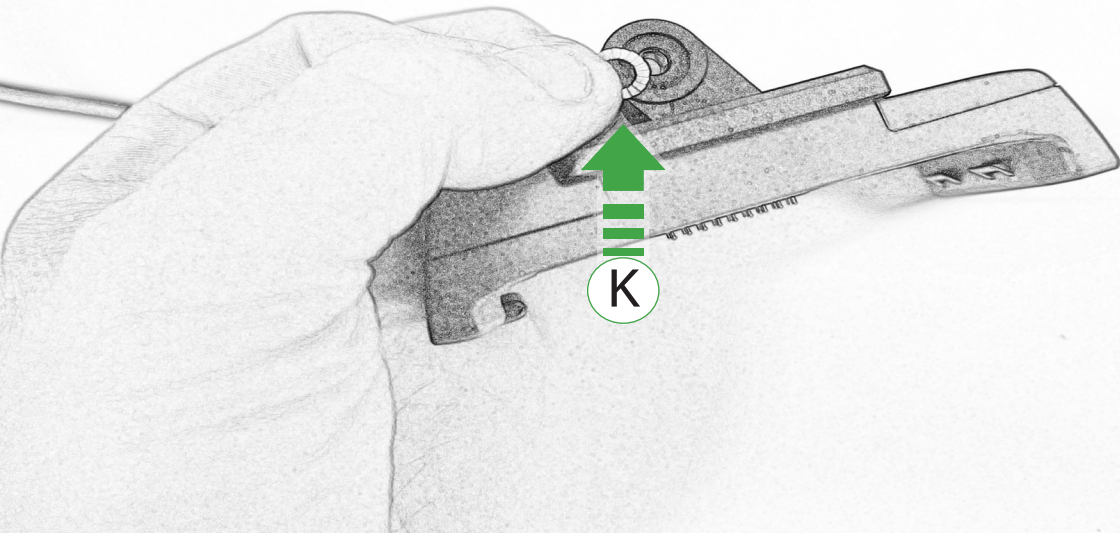

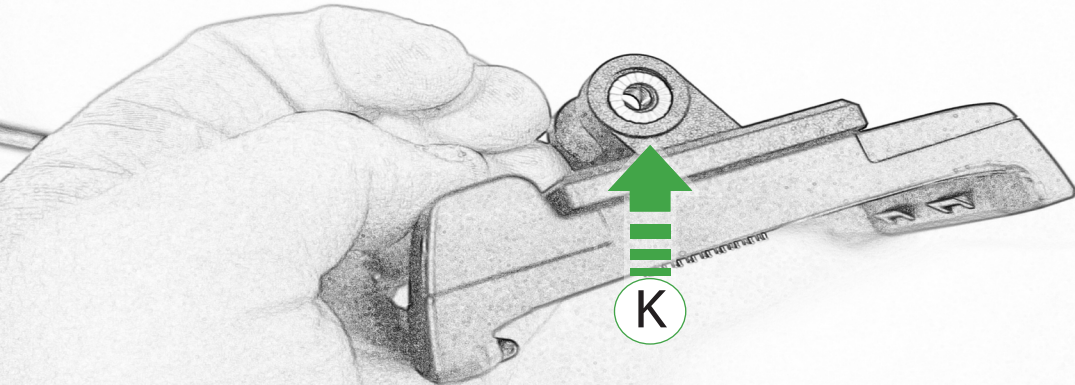

Repeat
Both Sides

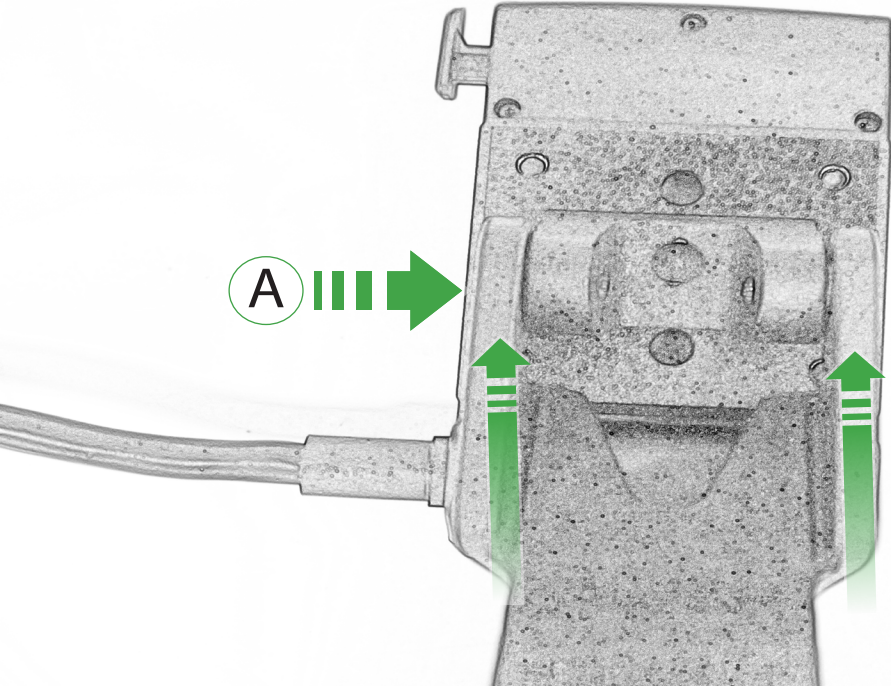

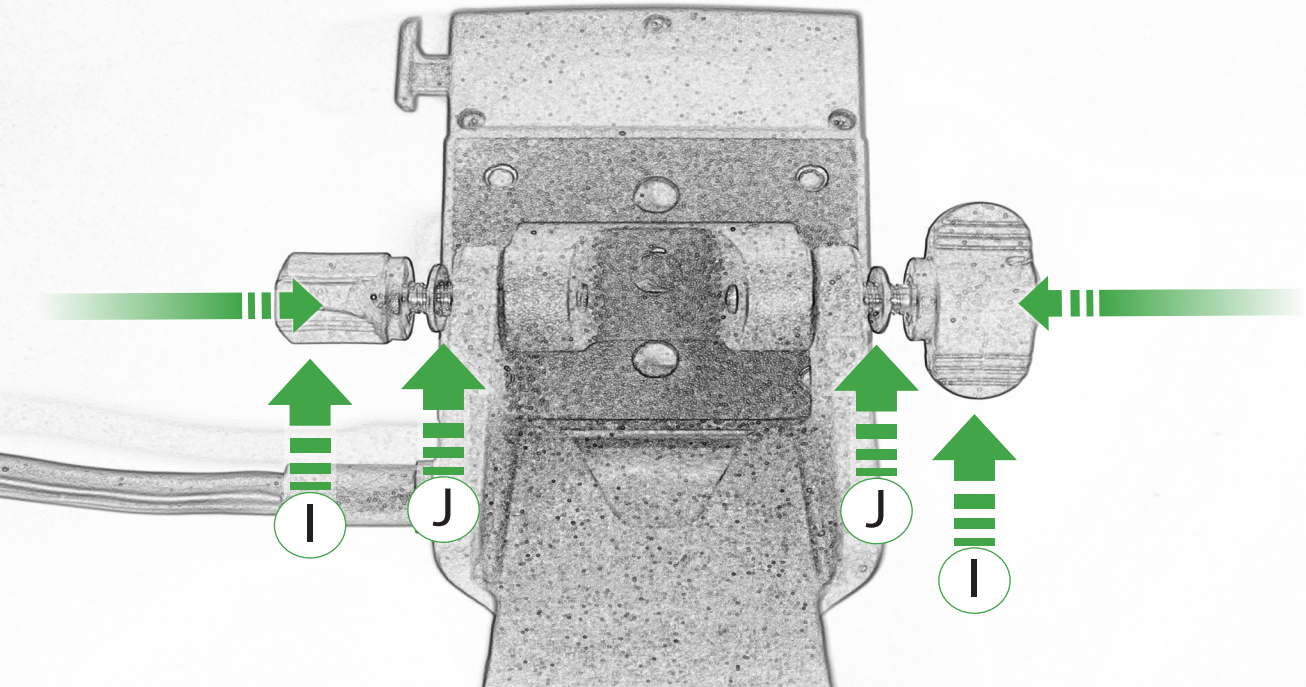

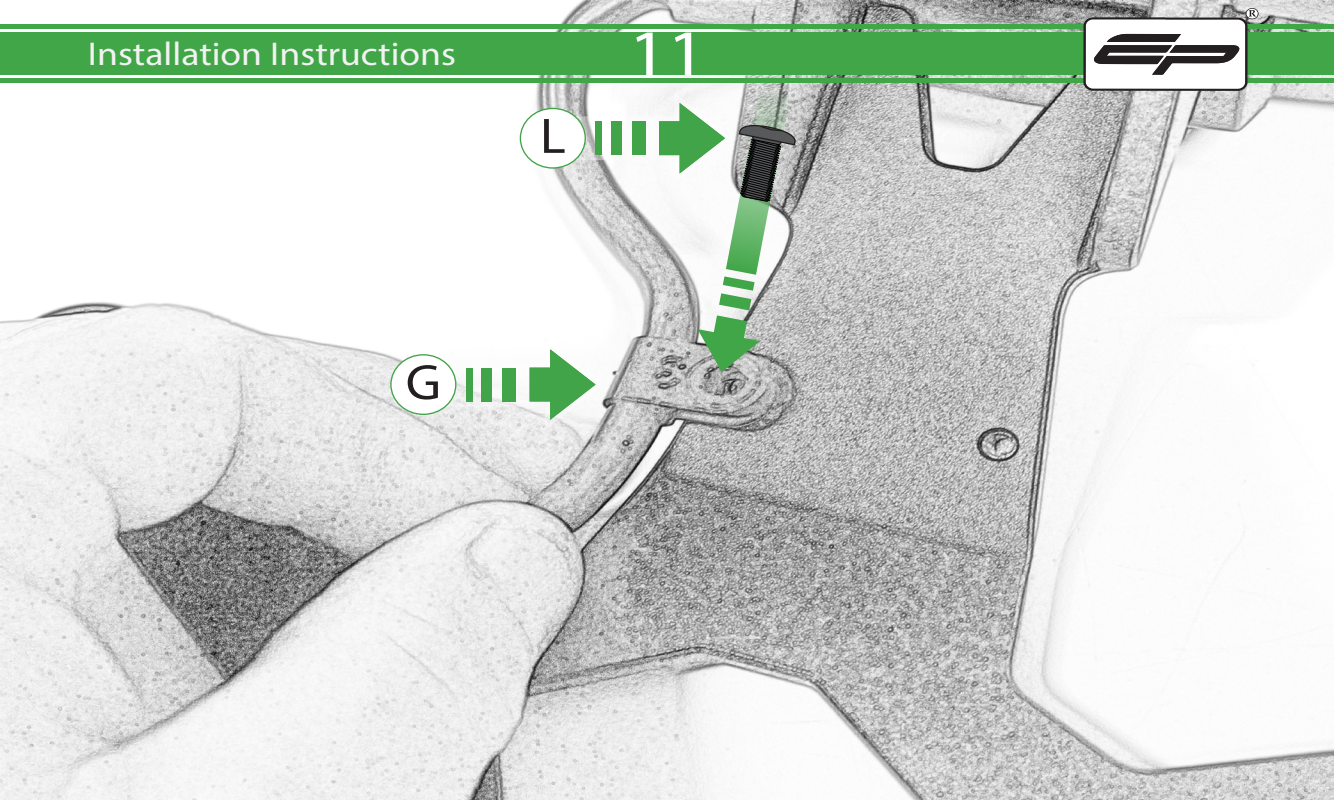

L



G



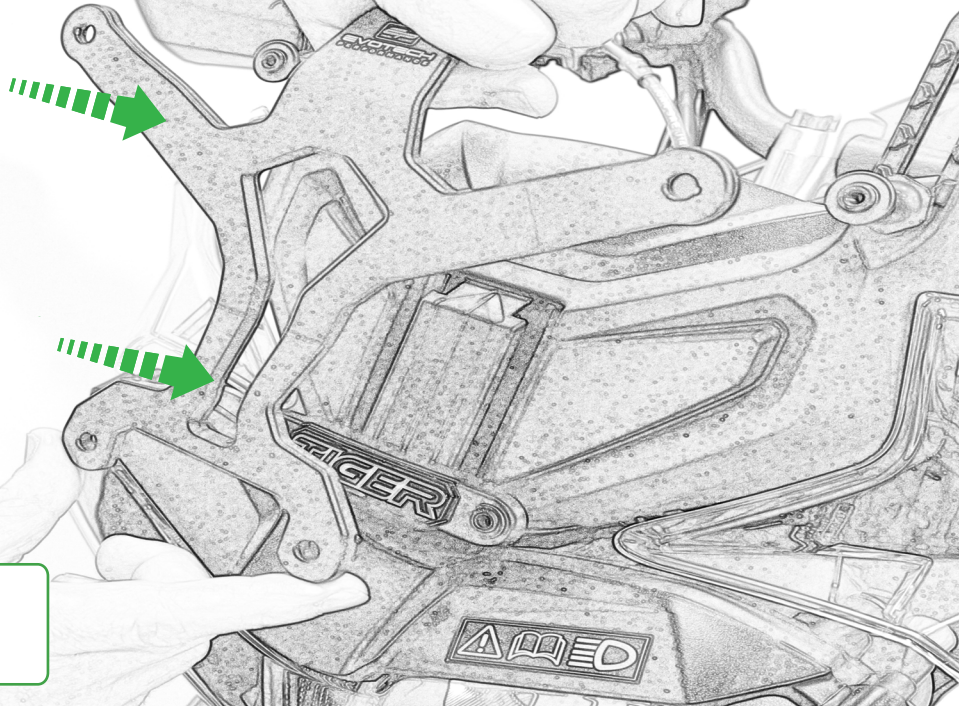

Caution

Locate Item In
Recess

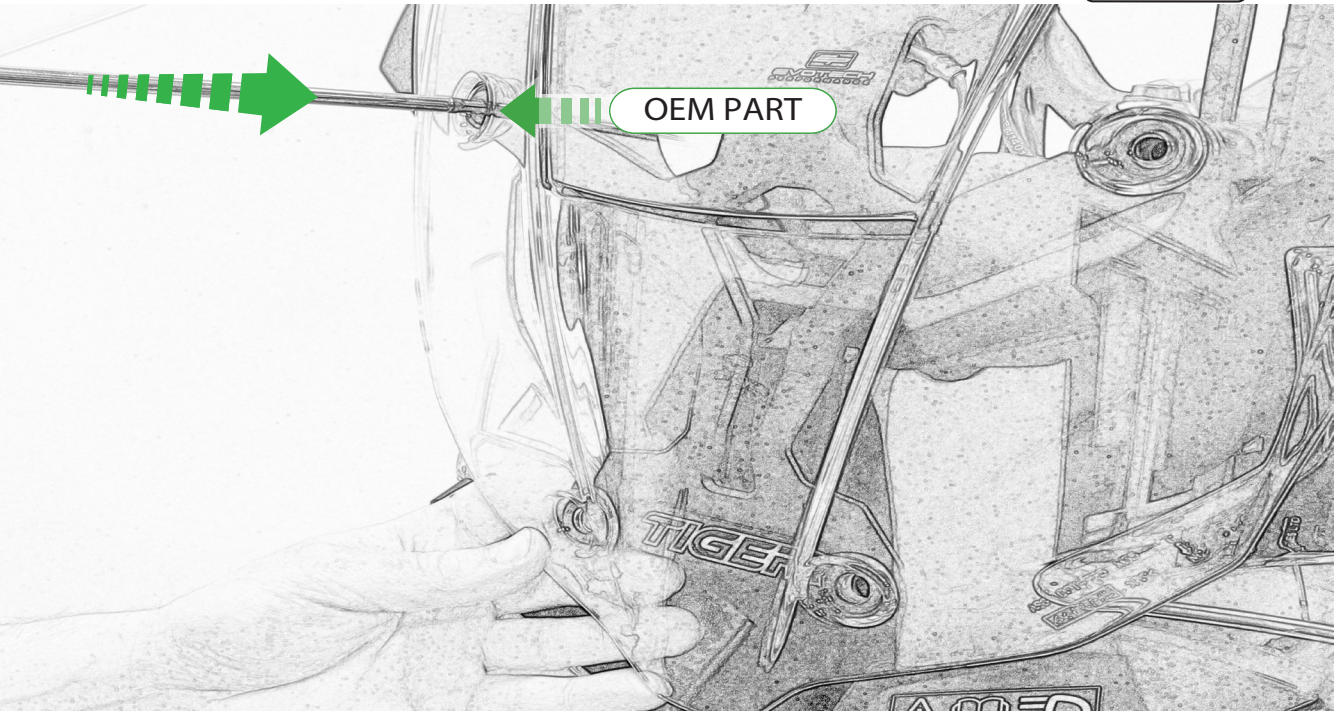

OEM PART

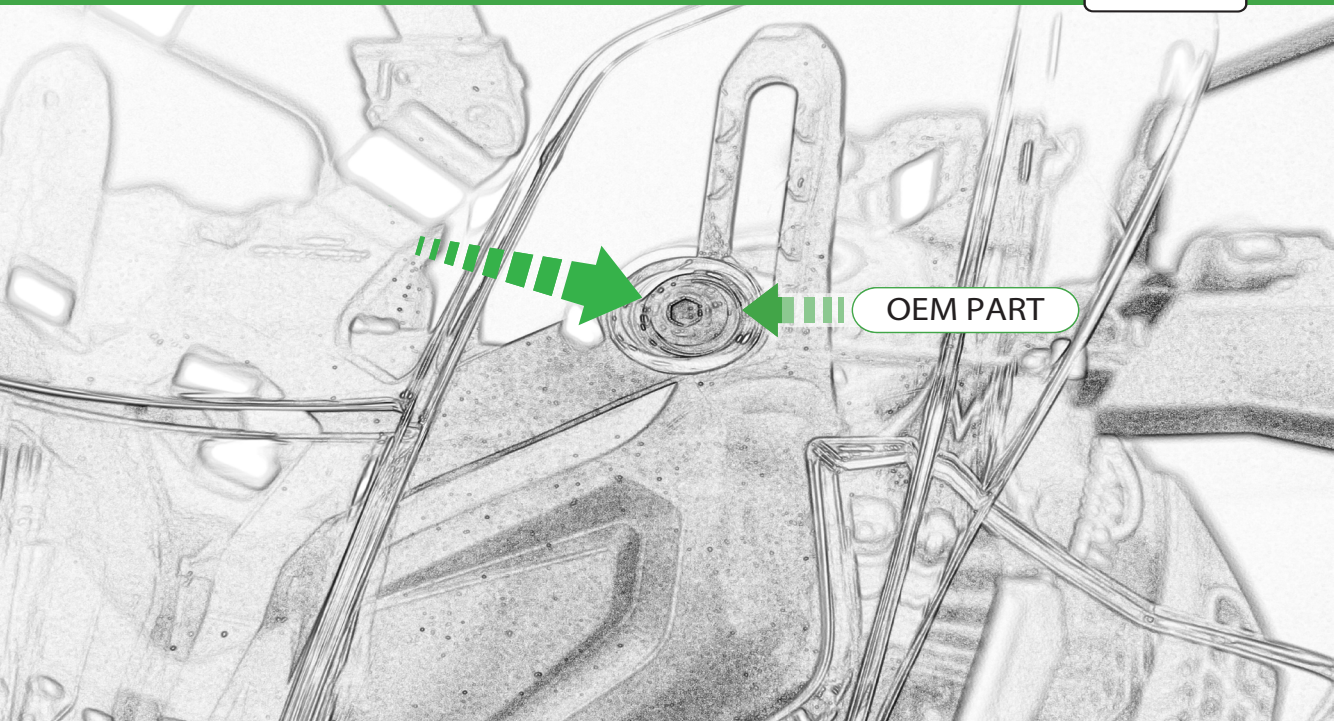

OEM PART

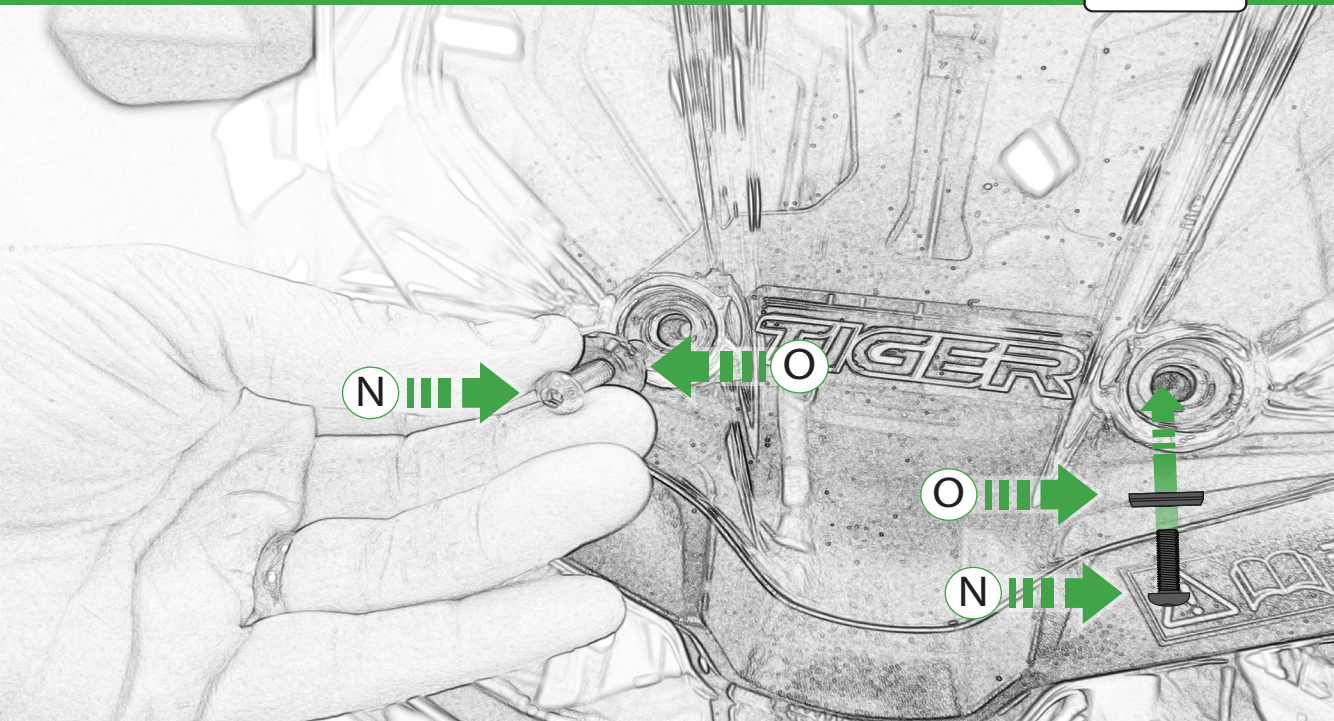



ESSENTIAL CHECKS

It is recommended that periodic inspections are made to ensure that all bolts are tightened to the specified torque settings.

Should the bike be involved in an accident a thorough inspection should be made and any components that have taken an impact, no matter how small, be replaced



EVOTECH®
P E R F O R M A N C E

www.evotech-performance.com