



EVOTECH®
P E R F O R M A N C E

Installation Instructions



YAMAHA YZF-R3 2015 RADIATOR GUARD

Product Reference - 12649

Kit Contents

- Ⓐ 1 x Radiator Guard
- Ⓑ 6 x 50mm x 10mm x 4mm Neoprene Foam

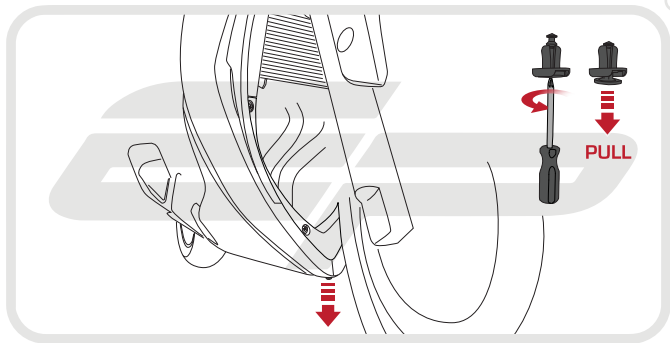

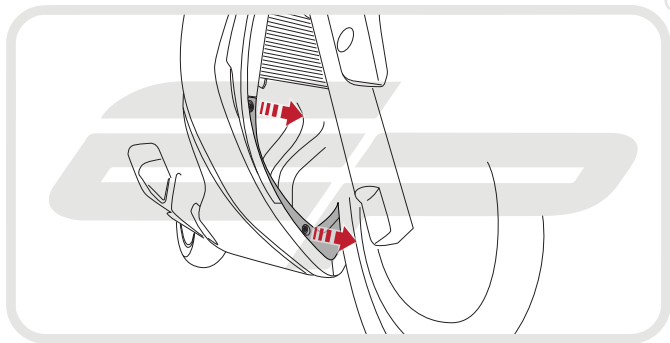

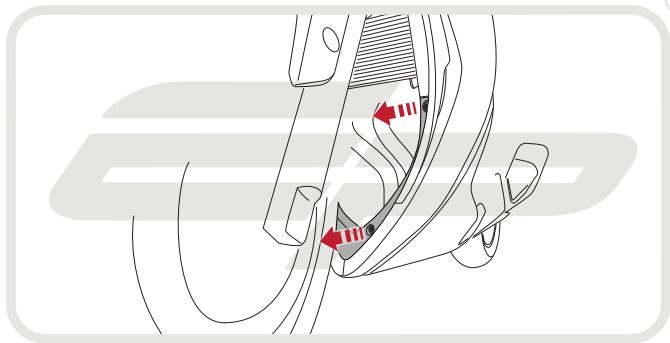

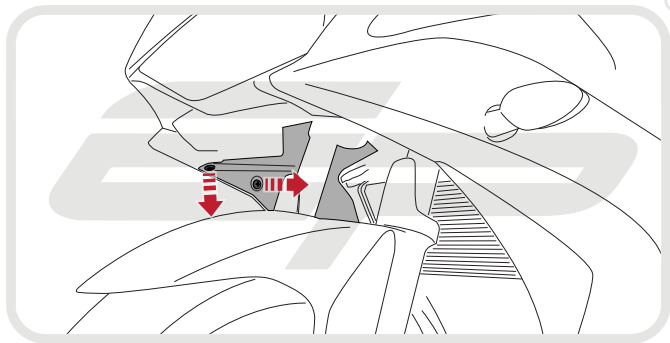

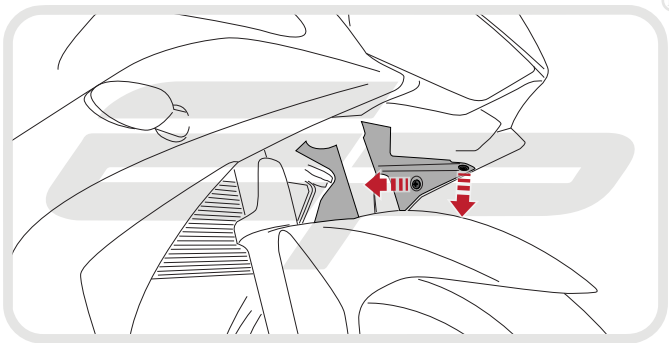

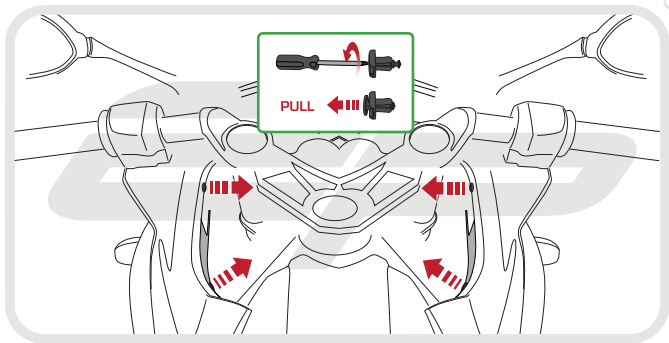

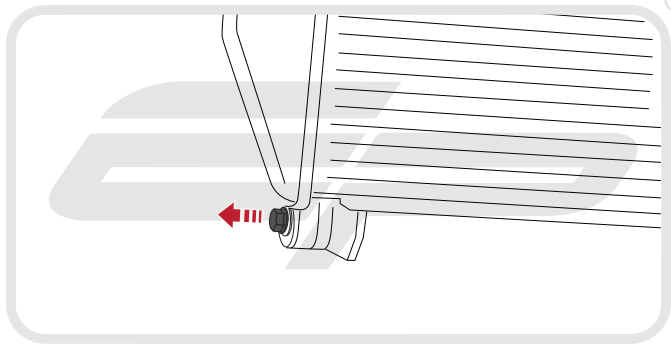

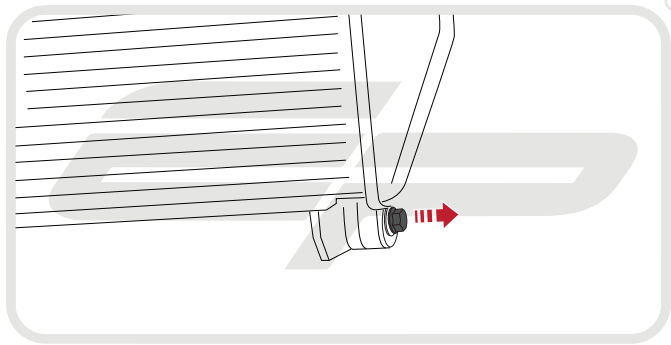

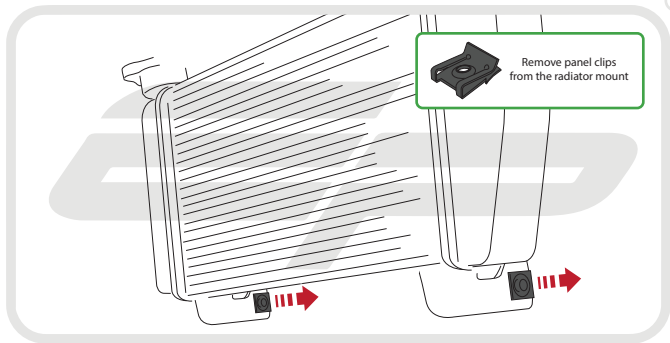

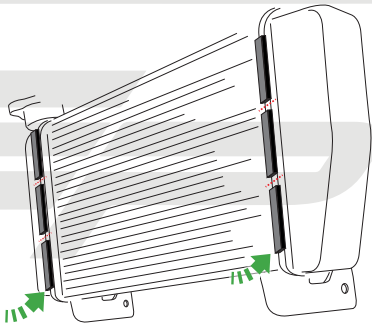
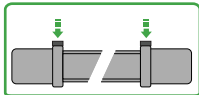



Ensure radiator guard
securely hooks over the
top lip of the radiator

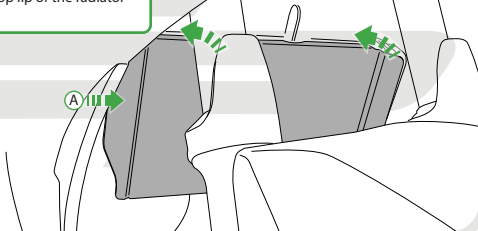

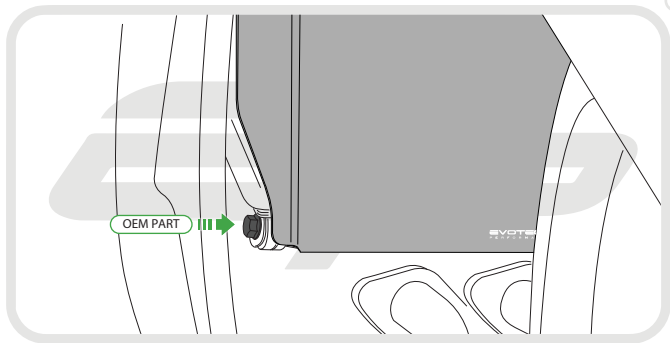

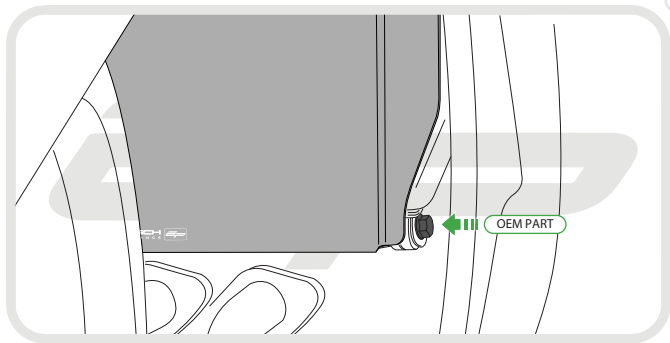



Reverse Stages

6 - 1



ESSENTIAL CHECKS

It is recommended that periodic inspections are made to ensure that dirt and debris have not become trapped between the guard and the radiator/oil cooler. Such dirt and debris would reduce the cooling efficiency of the radiator/oil cooler.

It is recommended that periodic inspections are made to ensure that all fixings are fully tightend.



EVOTECH®
P E R F O R M A N C E

www.evotech-performance.com