



www.barkbusters.net

FITTING INSTRUCTIONS for...

- HONDA CRF1100L AFRICA TWIN - DCT ('20 on)
- HONDA CRF1100L AFRICA TWIN - non DCT ('20 on)
- HONDA CRF1100L AFRICA TWIN Adventure Sports - DCT ('20 on)
- HONDA CRF1100L AFRICA TWIN Adventure Sports - non DCT ('20 on)

Preparation

- Remove original factory handguard components if installed. Reattach the original brake & clutch lever screws with the flanged spacers and nuts. Tighten the original screws to the manufacturer's specified torque.
- Remove original external handlebar end weights and metal clips. **NOTE:** Retain internal handlebar weights.

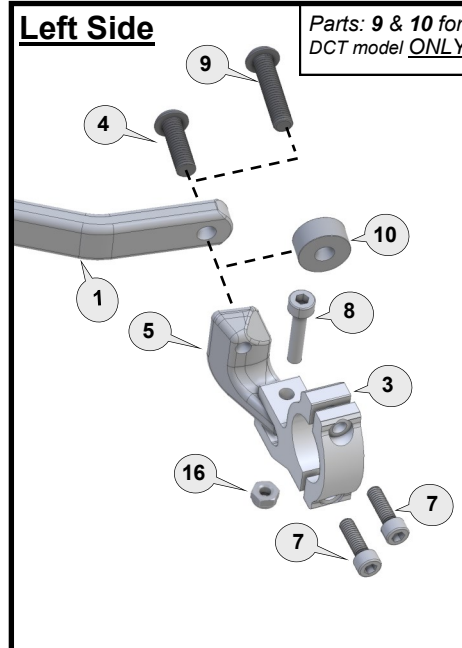
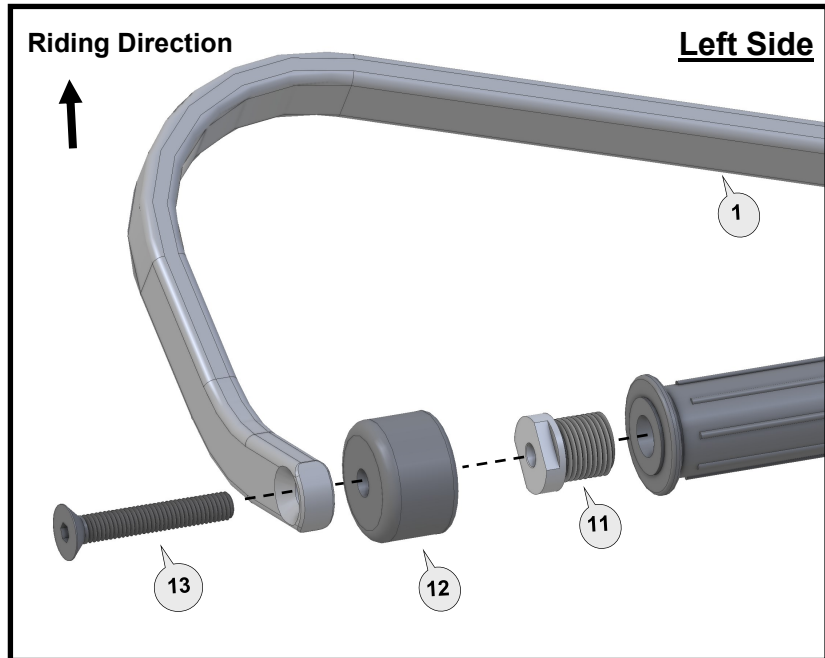

Installation for Left Side. Repeat for Right side with applicable parts.

Fit threaded insert (11) and tighten to specified torque setting. Loosely assemble the clamp to the handlebar as per diagram. Attach the handguard backbone with applicable parts to the handlebar end and also to the clamp connector (5).

Note DCT models: Use bolt (9) & spacer (10) on LEFT side only.

Position backbone so it is horizontal when viewed from the side and tighten all bolts in the following order: (13), (9 or 4), (7) then (8).

Important: Use the specified torque setting over page.

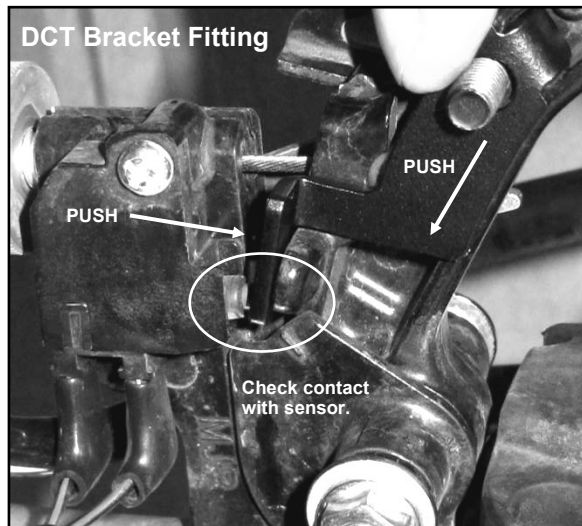
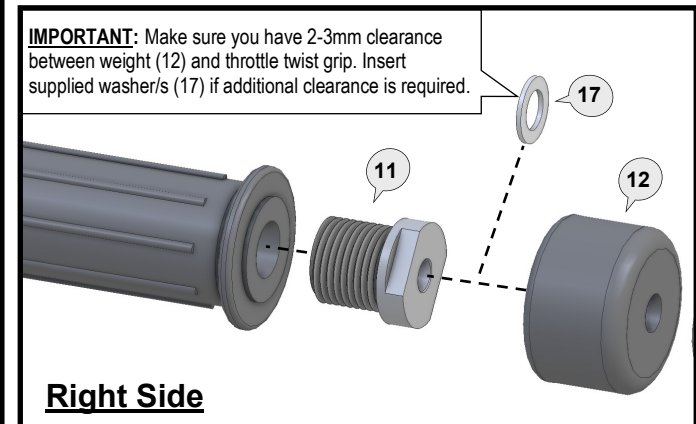

DCT model ONLY:

1. Loosen park brake cable adjuster a few turns.
2. Remove original screw from the park brake lock and replace with screw (14) then tighten as specified.
3. Mount Pressed Metal Bracket (15) between the brake lever and parking brake sensor and secure with Nut (16) as shown, then tighten as specified.
4. Set park brake cable adjuster to desired position and secure.

IMPORTANT:

Position bracket (15) as shown in picture before tightening.

← see image

Check the bracket makes contact with the sensor. Slight repositioning of the sensor may also be necessary.



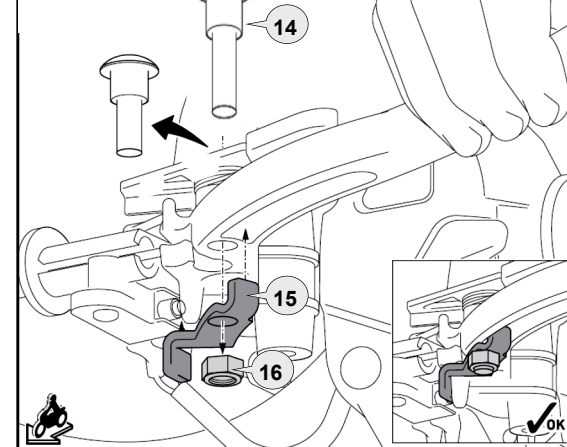



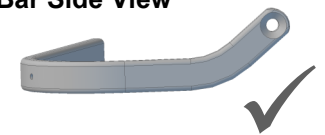

DCT model ONLY











Bar Side View

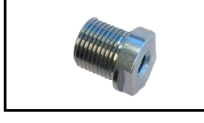

INS-BHG-082-02-NP

<p>1 Aluminium Bar - LEFT</p>  <p>PN: BAR-V-039-L Pcs. 1</p>	<p>2 Aluminium Bar - RIGHT</p>  <p>PN: BAR-V-039-R Pcs. 1</p>	<p>3 Multi Fit Clamp 28</p>  <p>PN: MFC-28 Pcs. Set of 2</p>	<p>4 Button Head Bolt 25mm</p>  <p>PN: M8X25BHCSZP Pcs. 2</p>	<p>5 Connector</p>  <p>PN: CP8-L Pcs. 1</p>	<p>6 Connector</p>  <p>PN: CP8-R Pcs. 1</p>	<p>7 Socket Head Bolt 20mm</p>  <p>PN: M6X20SHCSZP Pcs. 4</p>	<p>8 Socket Head Bolt 30mm</p>  <p>PN: M6X30SHCSZP Pcs. 2</p>
--	---	--	--	---	---	---	---

<p>9 Button Head Bolt 35mm</p>  <p>PN: M8X35BHCSZP Pcs. 1</p>	<p>10 Spacer 10mm</p>  <p>PN: BSSRT10 Pcs. 1</p>	<p>11 Threaded Insert</p>  <p>PN: BESF4 Pcs. 2</p>	<p>12 Bar End Weight</p>  <p>PN: BEW35 Pcs. 2</p>	<p>13 Flat Head Bolt 45mm</p>  <p>PN: M8X45FHCSZP Pcs. 2</p>	<p>14 Shoulder Bolt 30mm</p>  <p>PN: M6X30SB Pcs. 1</p>	<p>15 Pressed Metal Bracket</p>  <p>PN: BPM1 Pcs. 1</p>	<p>16 Nylock Nut 6mm</p>  <p>PN: M6LN Pcs. 3</p>
---	--	--	--	--	---	---	--

17
M8 Flat Washer

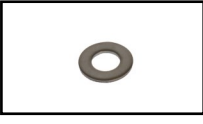



PN: M8FW-SS
Pcs. 2

NOTE:
Part Numbers 9, 10, 14, 15 & one of 16, required for DCT models only.

Recommended Torque Settings	
M6	10 Nm (7.4 lbf ft)
M8	20 Nm (14.8 lbf ft)
M18 (item 11)	21Nm (15.5 lbf ft)

Personalise Your Protection
Guard options sold separately

	JET-003
	VPS-003
	STM-003
CARBON	BCF-003



Email: info@barkbusters.net
Web: www.barkbusters.net



CAUTION:

Installation of the handguard is safety-relevant work and can be complicated. We recommend the installation be performed by a motorcycle service technician. Rideworx accepts no liability for damages caused by improper mounting. All screws, bolts and nuts, including all replacement hardware provided by Rideworx, should be tightened to the torque specified in the table. After the first 50km of riding check all screws, bolts and nuts are tightened to the correct torque. We recommend a medium strength liquid thread lock product on all fasteners.

WARNING:

Check operation of all handlebar controls, specifically the throttle, front brake, kill switch and clutch to ensure they are operating correctly and are in accordance with the OEM specifications. Do not ride the motorcycle if any controls are not operating correctly or if rear view mirror vision is obscured. Check periodically that all bolts are tight.

Disclaimer:

A failure to follow these fitting instructions could cause serious injury, death or property damage. These handguards are intended solely for use with motorcycles/ATV/snowmobiles/scooters that have not been modified. They are not designed to prevent injury or death while riding or in an accident or crash. The user must ensure that all controls are free of the handguards every time that they ride. By installing and/or using this product you acknowledge that you accept these terms and have followed the fitting instructions.